

26MM 904X298 CM QBV3 (ART 8304EXT400)

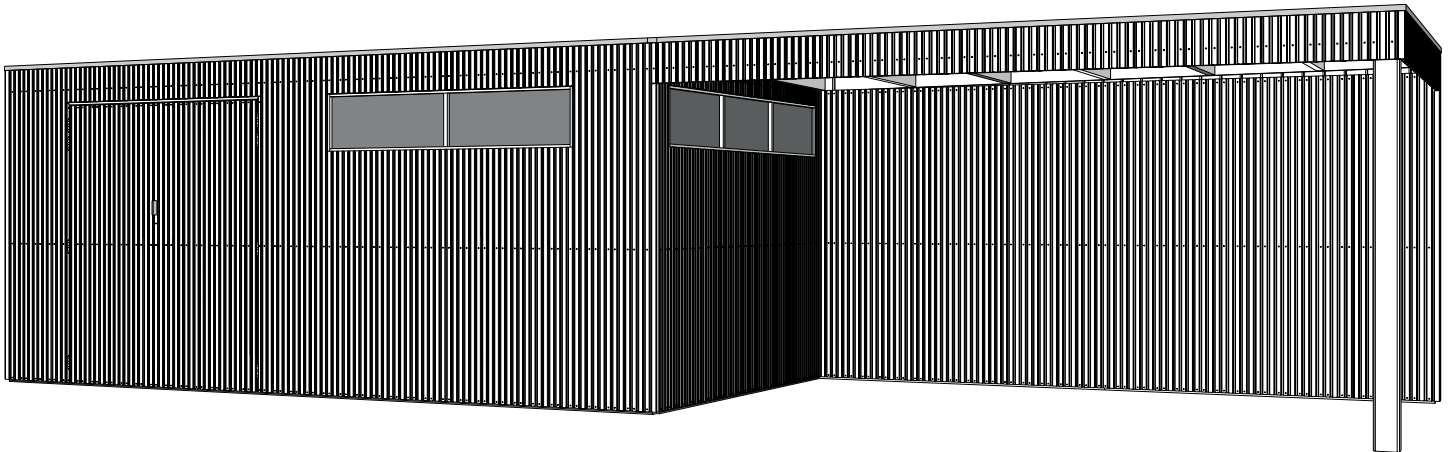

# WOODLANDS

QUALITY CABINS



## GEDETAILEERDE ONDERDELENLIJST - LISTE D'INVENTAIRE DETAILLEE

Download uw montage instructies op [www.gardenas.be](http://www.gardenas.be)

Téléchargez vos instructions de montage sur [www.gardenas.be](http://www.gardenas.be)

**8000FR5030A**

**FRAME**

Artikel nr Nr Article	Afmeting / Dimension		Secctie/ Section	#	Functie / Fonction
	A	B	C		

**Kader - Cadre**

**Basis - Base**

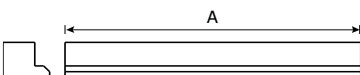

**Bovenkant - Partie supérieure**

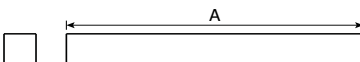

**Tussenstukken - Parties intermédiaires**

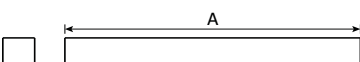

**Verticaal**

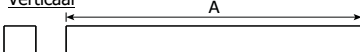

**Positioneringslatten - Lattes de positionnement**

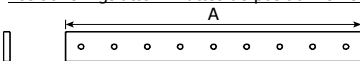

**Raam - Fenêtre**

**Glaslatten - Lattes de verre**

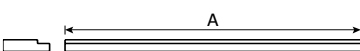

**Glas - Verre**

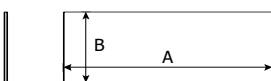

**Deur - Porte**

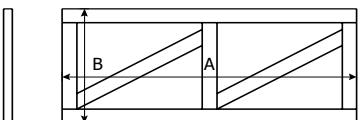

**Dak - Toiture**

**Kader - Cadre**

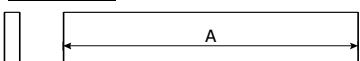

**Dakbalk - Panne**

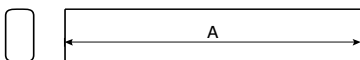

**OSB dakplaat / Panneau de toit OSB**

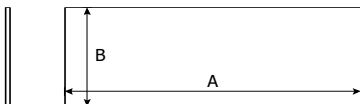

**EPDM**



**Regenpijp - Descente**

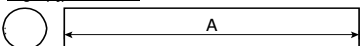

**ALU hoekprofiel - Profilé en ALU**

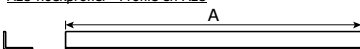

NPF/2186IMG	2186	(-)	(-)	45x56	<u>1</u>	voorwand linker deel / paroi avant partie gauche
NPF/2755IMG	2755	(-)	(-)	45x56	<u>1</u>	voorwand rechter deel / paroi avant partie droite
NPF/2849IMG	2849	(-)	(-)	45x56	<u>2</u>	zijwand / paroi latéral
NPF/2470IMG	2470	(-)	(-)	45x56	<u>2</u>	achterwand / paroi arrière
FR1/2186	2186	(-)	(-)	38x38	<u>1</u>	voorwand linker deel / paroi avant partie gauche
FR1/2755	2755	(-)	(-)	38x38	<u>1</u>	voorwand rechter deel / paroi avant partie droite
FR1/2849	2849	(-)	(-)	38x38	<u>2</u>	zijwand / paroi latéral
FR1/2470	2470	(-)	(-)	38x38	<u>2</u>	achterwand / paroi arrière
FR1/0458	458	(-)	(-)	38x38	<u>1</u>	voorwand linker deel / façade partie gauche
FR1/1614	1614	(-)	(-)	38x38	<u>1</u>	voorwand boven deur / façade au-dessus la porte
FR1/1299	1299	(-)	(-)	38x38	<u>1</u>	voorwand rechter deel 1 / façade partie droite 1
FR1/1342	1342	(-)	(-)	38x38	<u>1</u>	voorwand rechter deel 2 / façade partie droite 2
FR1/0935	935	(-)	(-)	38x38	<u>2</u>	zijwand linker deel / paroi latéral partie gauche
FR1/0835	835	(-)	(-)	38x38	<u>2</u>	zijwand midden deel / paroi latéral partie centrale
FR1/0926	926	(-)	(-)	38x38	<u>2</u>	zijwand rechter deel / paroi latéral partie droite
FR1/1178	1178	(-)	(-)	38x38	<u>4</u>	achterwand / paroi arrière
FR1/1977	1977	(-)	(-)	38x38	<u>20</u>	verticaal / vertical
HB/1134/G	1134	(-)	(-)	29x3	<u>34</u>	9 gaten / 9 trous
HB/1134	1134	(-)	(-)	29x3	<u>16</u>	zonder gaten / sans trous
GLP/0333	333	(-)	(-)	57x15	<u>4</u>	verticaal / vertical
GLP/0835	835	(-)	(-)	57x15	<u>2</u>	horizontaal / horizontal
GLP/0892	892	(-)	(-)	57x15	<u>8</u>	horizontaal / horizontal
GH/0358/0860	860	358	4		<u>5</u>	glas / verre
QBV/DD/784/L	1911	784	(-)	28x95	<u>1</u>	deurvleugel met slot (links) / battant pour serrure (gauche)
QBV/DD/784/R	1911	784	(-)	28x95	<u>1</u>	deurvleugel (rechts) / battant (droite)
S/026/095/0040	40	(-)	(-)	95x26	<u>18</u>	ondersteuning kader / support cadre
S/026/095/2863	2863	(-)	(-)	95x26	<u>2</u>	zijkant / côté latéral
S/026/095/2440	2440	(-)	(-)	95x26	<u>4</u>	voor- en achterkant / côté frontal et arrière
P1/2872	2872	(-)	(-)	95x45	<u>7</u>	dakbalk / panne
OSB3/018/1220/590	1220	590	18		<u>1</u>	OSB dakplaat / panneau de toit OSB
OSB3/018/2440/590	2440	590	18		<u>10</u>	OSB dakplaat / panneau de toit OSB
EPDM/3300/5100	3300	5100	(-)		<u>1</u>	EPDM folie / bâche EPDM
406001					<u>1</u>	dakdoorvoer / avaloir
402003	2000	80	(-)		<u>1</u>	buis / tuyaux
ALU/L/3020	3020	(-)	(-)		<u>2</u>	zijkant / côté latéral
ALU/L/2560	2560	(-)	(-)		<u>4</u>	voor- en achterkant / côté frontal et arrière
B/8000FR5030A					<u>1</u>	zak beslag / sachet quincaillerie (8304)

# Onderdelenlijst Liste d'inventaire

## Typ

## **FRAB 403x298 cm**

### 8000FRAB4030

Artikel nr Nr Article	Afmeting / Dimension			Sectie/ Section	#	Functie / Fonction
	A	B	C			

#### Kader - Cadre

##### Basis - Base

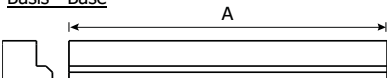

##### Bovenkant - Partie supérieure

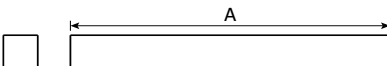

##### Tussenstukken - Parties intermédiaires

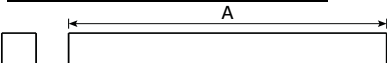

##### Verticaal

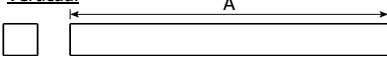

##### Positioneringslatten - Lattes de positionnement

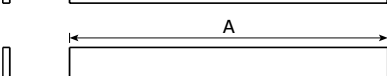
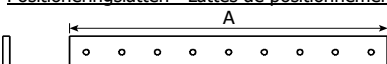

#### Dak - Toiture

##### Ligger - Traverse

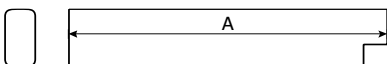

##### Kader - Cadre

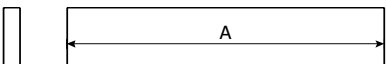

##### Dakbalk - Panne

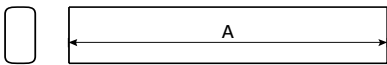

##### OSB dakplaat / Panneau de toit OSB

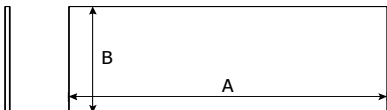

##### EPDM



##### ALU hoekprofiel - Profilé en ALU

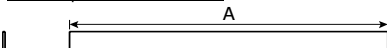

NPF/2016IMG	2016	(-)	(-)	45x56	<b>2</b>	achterwand / paroi arrière
FR1/2016	2016	(-)	(-)	38x38	<b>2</b>	achterwand / paroi arrière
FR1/0951	951	(-)	(-)	38x38	<b>4</b>	achterwand / paroi arrière
FR1/1977	1977	(-)	(-)	38x38	<b>6</b>	verticaal / vertical
HB/1134/G	1134	(-)	(-)	29x3	<b>23</b>	9 gaten / 9 trous
HB/1134	1134	(-)	(-)	29x3	<b>17</b>	zonder gaten / sans trous
599913	2880	(-)	(-)	95x45	<b>1</b>	zijkant / côté latéral
599916	4070	(-)	(-)	95x45	<b>1</b>	voorkant / façade
S/026/095/1936	1936	(-)	(-)	95x26	<b>2</b>	achterkant / côté arrière
S/026/095/2863	2863	(-)	(-)	95x26	<b>1</b>	zijkant / côté latéral
P1/2850	2850	(-)	(-)	95x45	<b>5</b>	dakbalk / panne
OSB3/018/2440/590	2440	590	18		<b>8</b>	OSB dakplaat / panneau de toit OSB
EPDM/3100/4100	3100	4100	(-)		<b>1</b>	EPDM folie / bâche EPDM
ALU/L/2125	2125	(-)	(-)		<b>4</b>	voor- en achterkant / côté frontal et arrière
B/8000FRAB4030					<b>1</b>	zak beslag / sachet quincaillerie (8330AB4030)

VOORZIJDDE - FACADE

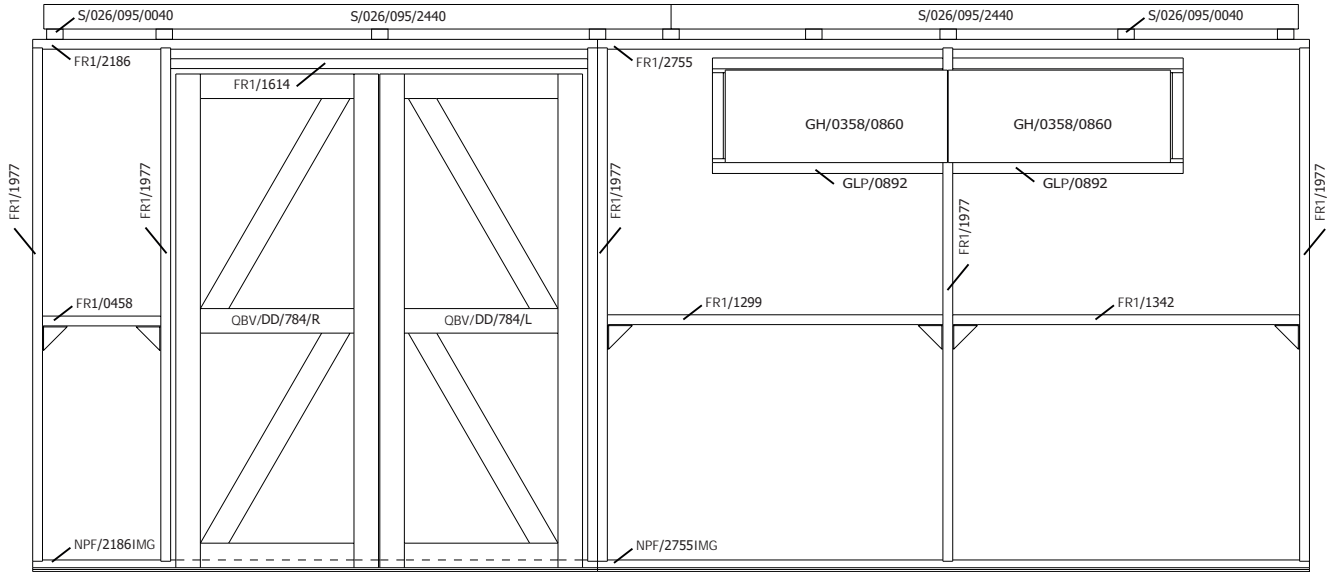

ZIJWAND RAAM - PAROI LATERALE FENETRE

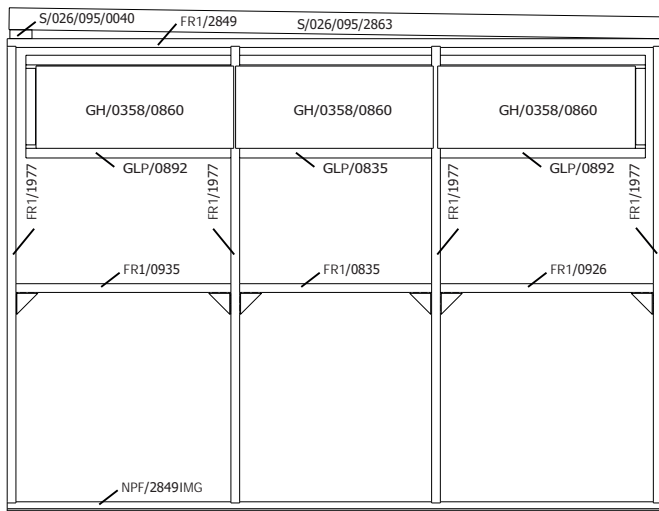

ZIJWAND - PAROI LATERALE

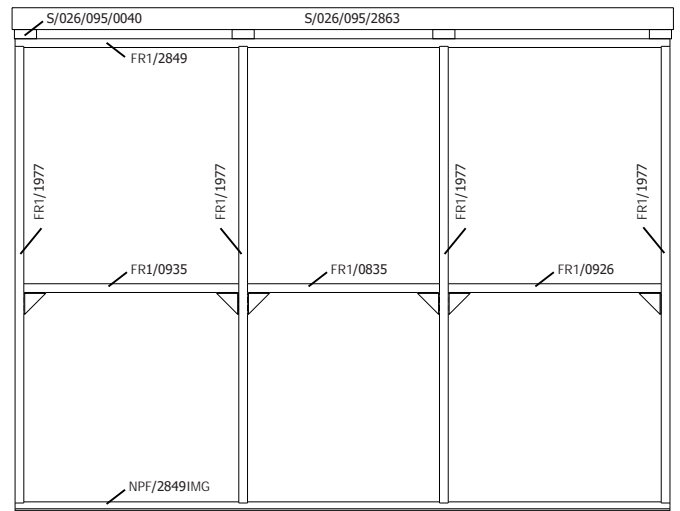

RUGZIJDDE - PAROI ARRIERE

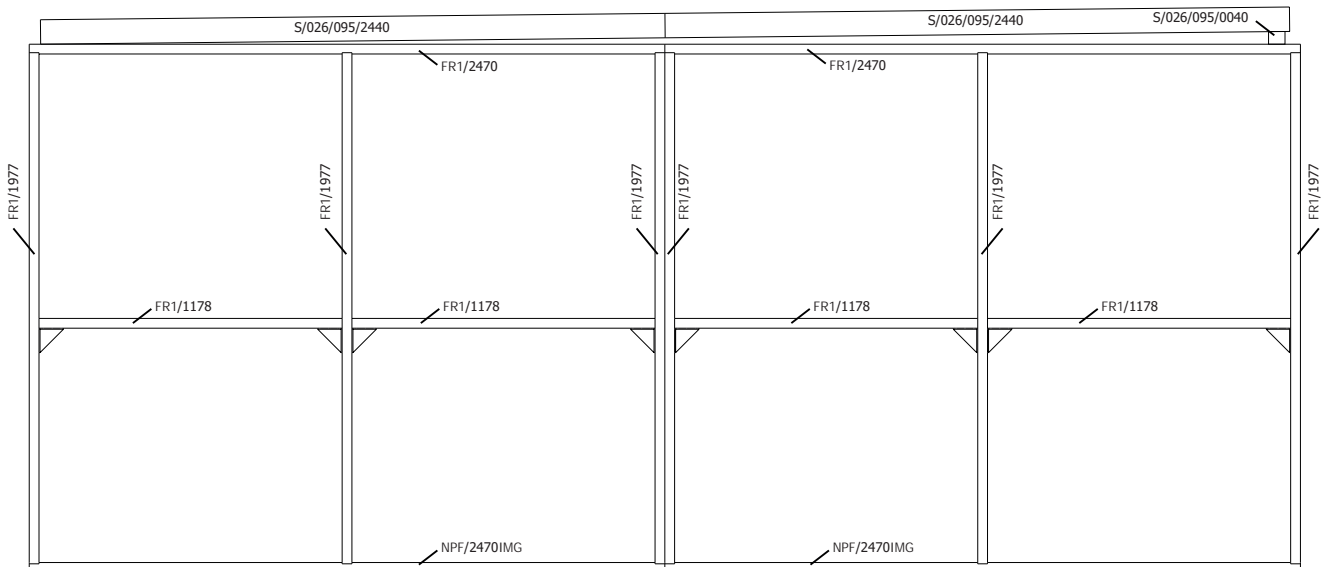

VOORZIJDE - FACADE

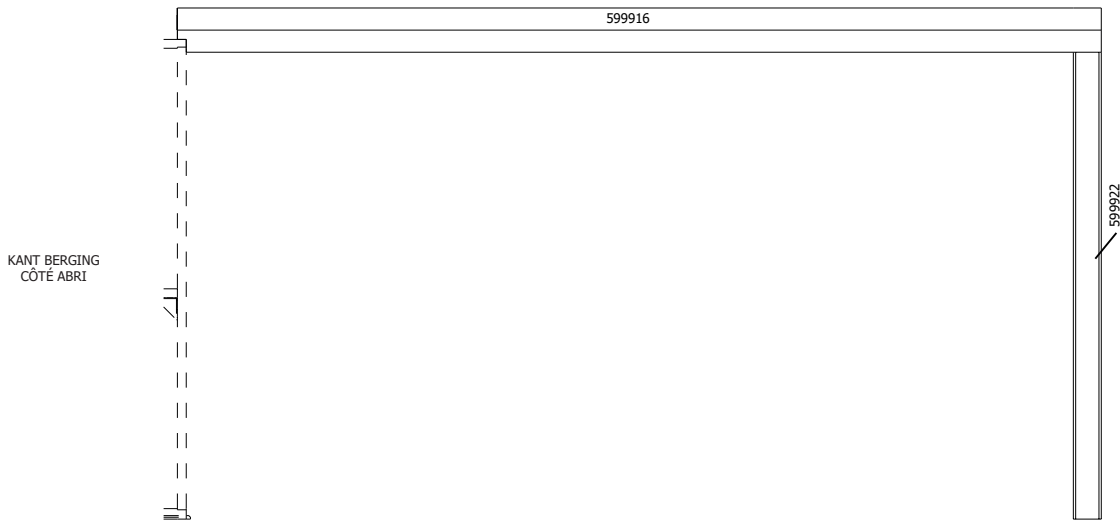

ZIJWAND - PAROI LATERALE

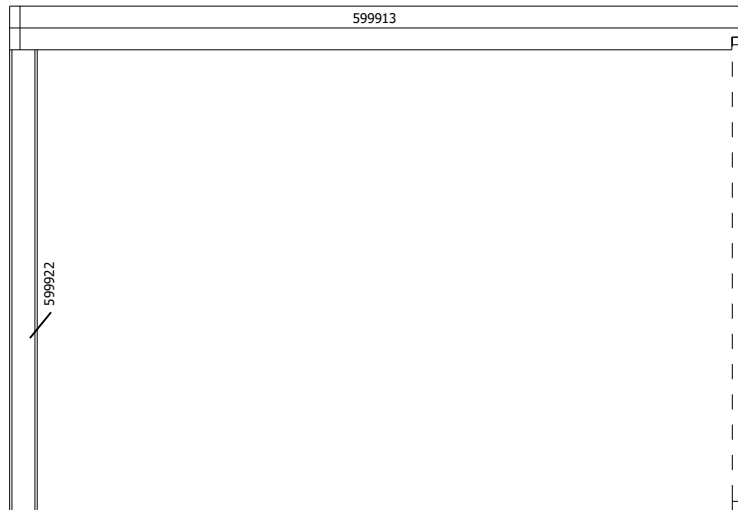

RUGZIJDE - PAROI ARRIERE

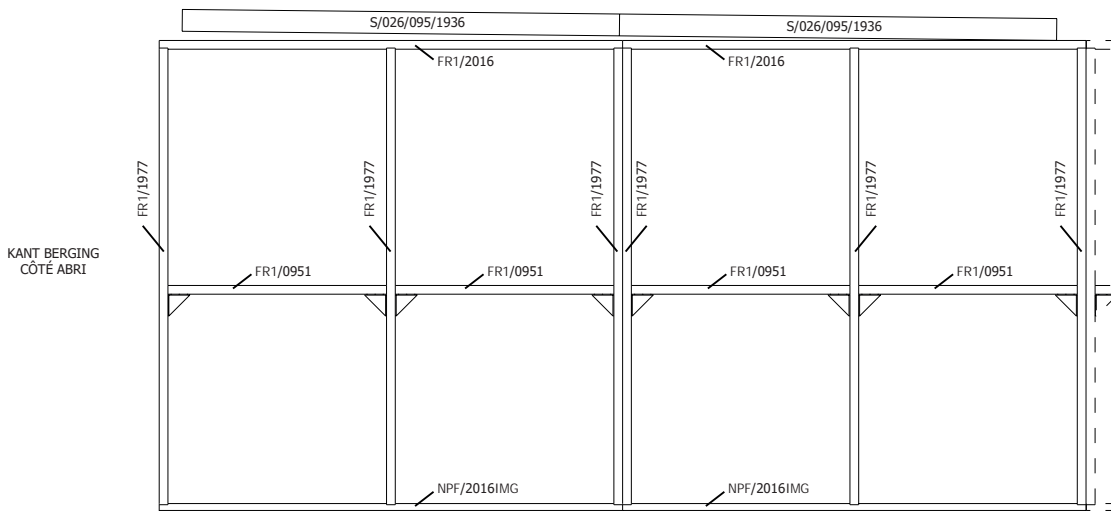

# Onderdelenlijst Liste d'inventaire

## Typ

## 26 QBV3 500x298 cm

### 8304

Artikel nr Nr Article	Afmeting / Dimension			Sectie/ Section	#	Functie / Fonction
	A	B	C			

#### Bekleding - Bardage

Hoekprofiel - Cornière

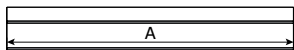

HPQBV1/2200	2200	(-)	(-)	60x41	<b>4</b>	hoekprofiel / cornière
-------------	------	-----	-----	-------	----------	------------------------

#### Plank tand & groef - Planche rainure & languette



QBV3/TG/0265/1	265	(-)	(-)	142x26	<b>48</b>	boven deur en raam / au-dessus porte et fenêtre
----------------	-----	-----	-----	--------	-----------	---

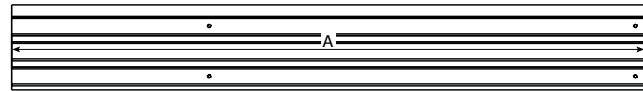

QBV3/TG/1567/2	1567	(-)	(-)	142x26	<b>35</b>	onder raam / en-dessous fenêtre
----------------	------	-----	-----	--------	-----------	---------------------------------



QBV3/TG/2200/3	2200	(-)	(-)	142x26	<b>76</b>	wanden / parois
QBV3/TG/1911/3	1911	(-)	(-)	142x26	<b>10</b>	deur / porte

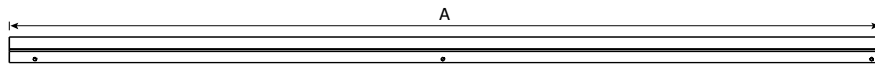

QBV1/T/1932/39/3	1932	(-)	(-)	39x26	<b>1</b>	rechts van deur / à droite de la porte
------------------	------	-----	-----	-------	----------	--

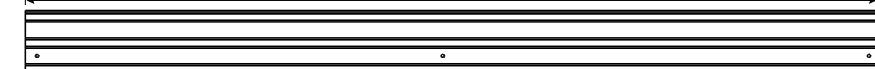

QBV3/G/1911/97/3	1911	(-)	(-)	97x26	<b>1</b>	rechter kant van rechter deur / côté droite de la porte droite
------------------	------	-----	-----	-------	----------	--

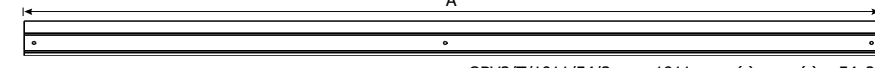

QBV3/T/1911/54/3	1911	(-)	(-)	54x26	<b>1</b>	linker kant van rechter deur / côté gauche de la porte droite
------------------	------	-----	-----	-------	----------	---

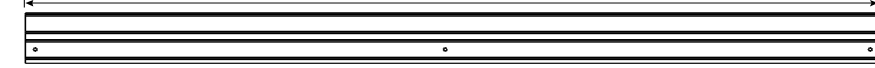

QBV3/G/1911/82/3	1911	(-)	(-)	82x26	<b>1</b>	rechter kant van linker deur / côté droite de la porte droite
------------------	------	-----	-----	-------	----------	---

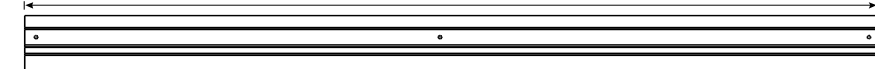

QBV3/T/1911/106/3	1911	(-)	(-)	106x26	<b>1</b>	linker kant van linker deur / côté gauche de la porte gauche
-------------------	------	-----	-----	--------	----------	--



QBV3/G/1932/30/3	1932	(-)	(-)	30x26	<b>1</b>	links van deur / à gauche de la porte
------------------	------	-----	-----	-------	----------	---------------------------------------

#### Raam - Fenêtre

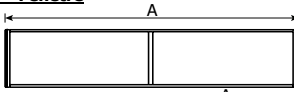

QBV/VR2L	1780	(-)	(-)	365x26	<b>1</b>	2 delig raam lang / fenêtre double longue
----------	------	-----	-----	--------	----------	---

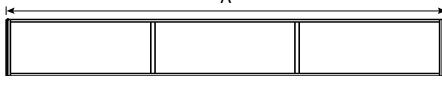

QBV/VR3	2662	(-)	(-)	365x26	<b>1</b>	3 delig raam / fenêtre triple
---------	------	-----	-----	--------	----------	-------------------------------

#### Deurlijst - Chambranle

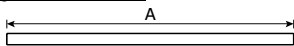

S/015/046/1947	1947	(-)	(-)	15x46	<b>2</b>	doorgang verticaal / passage vertical
----------------	------	-----	-----	-------	----------	---------------------------------------

S/015/075/1587	1587	(-)	(-)	15x75	<b>1</b>	doorgang horizontaal / passage horizontal
----------------	------	-----	-----	-------	----------	---

S/015/015/1931	1931	(-)	(-)	15x15	<b>2</b>	slaglat verticaal / battante vertical
----------------	------	-----	-----	-------	----------	---------------------------------------

S/015/015/1554	1554	(-)	(-)	15x15	<b>1</b>	slaglat horizontaal / battante horizontal
----------------	------	-----	-----	-------	----------	---

Onderdelenlijst  
Liste d'inventaire

Typ

**26 QBV3AB 403x298 cm**

**8330AB4030**

Artikel nr Nr Article	Afmeting / Dimension			Sectie/ Section	#	Functie / Fonction
	A	B	C			

**Bekleding - Bardage**

Hoekprofiel - Cornière

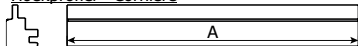

HPQBV1EXL/1932	1932	(-)	(-)	60x45	<b>1</b>	hoekprofiel voor montage van de extensie LINKS / profilé de coin pour un montage de l'extension à GAUCHE
----------------	------	-----	-----	-------	----------	---

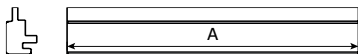

HPQBV1EXR/1932	1932	(-)	(-)	73x41	<b>1</b>	hoekprofiel voor montage van de extensie RECHTS / profilé de coin pour un montage de l'extension à DROIT
----------------	------	-----	-----	-------	----------	---

Plank tand & groef - Planche rainure & languette



QBV3/TG/0265/1	265	(-)	(-)	142x26	<b>55</b>	tegen liggers / contre les traverses
----------------	-----	-----	-----	--------	-----------	--------------------------------------

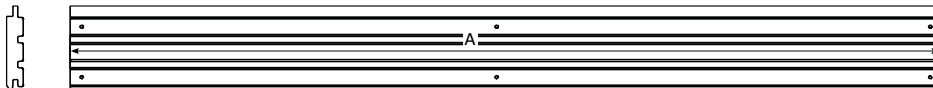

QBV3/TG/2045/3a	2045	(-)	(-)	142x26	<b>32</b>	onder extensie / sous l'extension
-----------------	------	-----	-----	--------	-----------	-----------------------------------

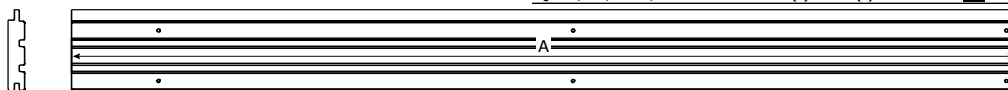

QBV3/TG/2200/3	2200	(-)	(-)	142x26	<b>32</b>	achterwand / paroi arrière
----------------	------	-----	-----	--------	-----------	----------------------------

Paal - poteau

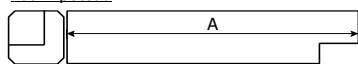

599922	2195	190	(-)	120x120	<b>1</b>	paal / poteau
--------	------	-----	-----	---------	----------	---------------

VOORZIJDJE - FACADE

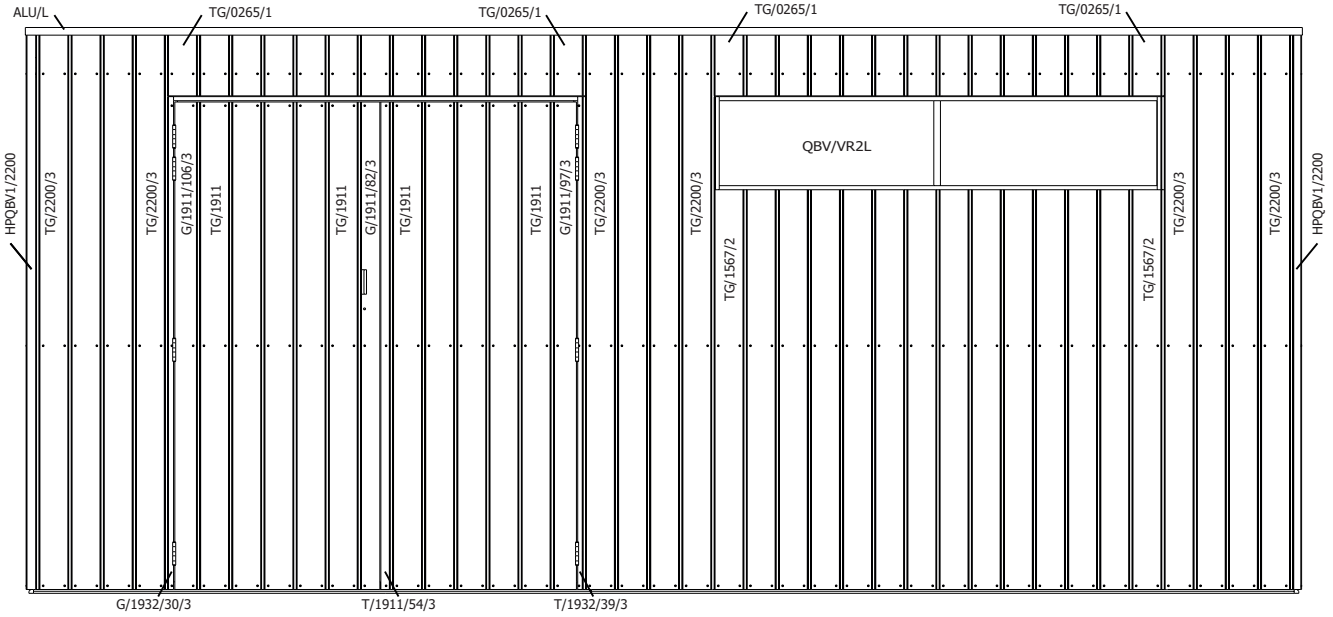

ZIJWAND RAAM - PAROI LATERALE FENETRE

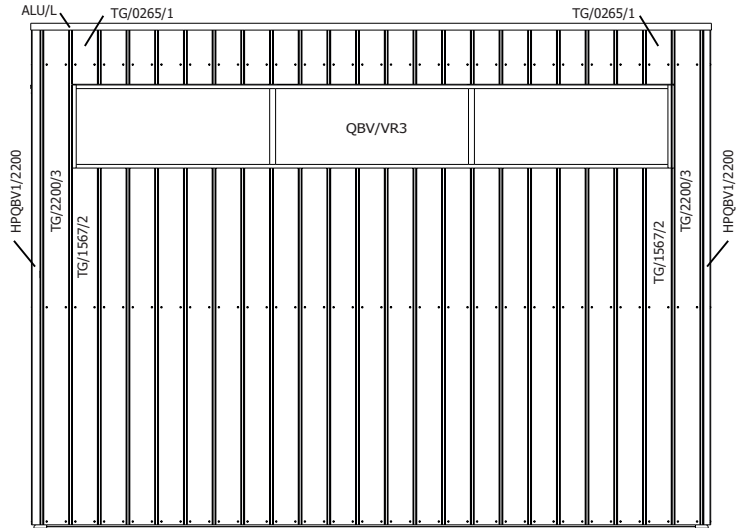

ZIJWAND - PAROI LATERALE

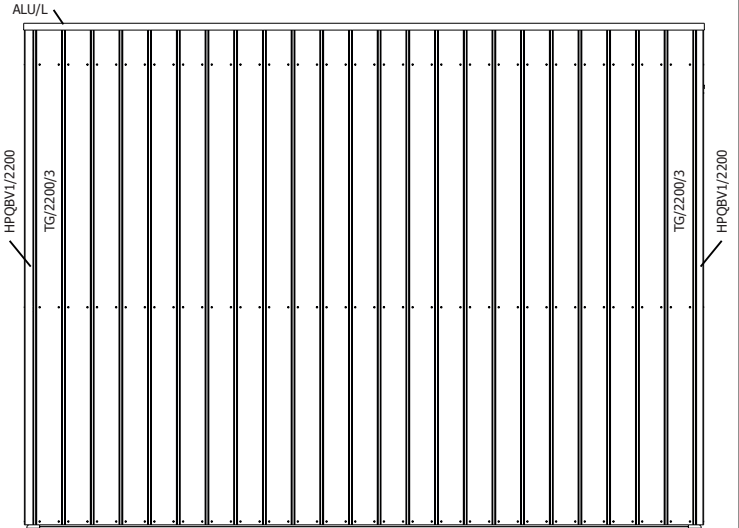

RUGZIJDJE - PAROI ARRIERE

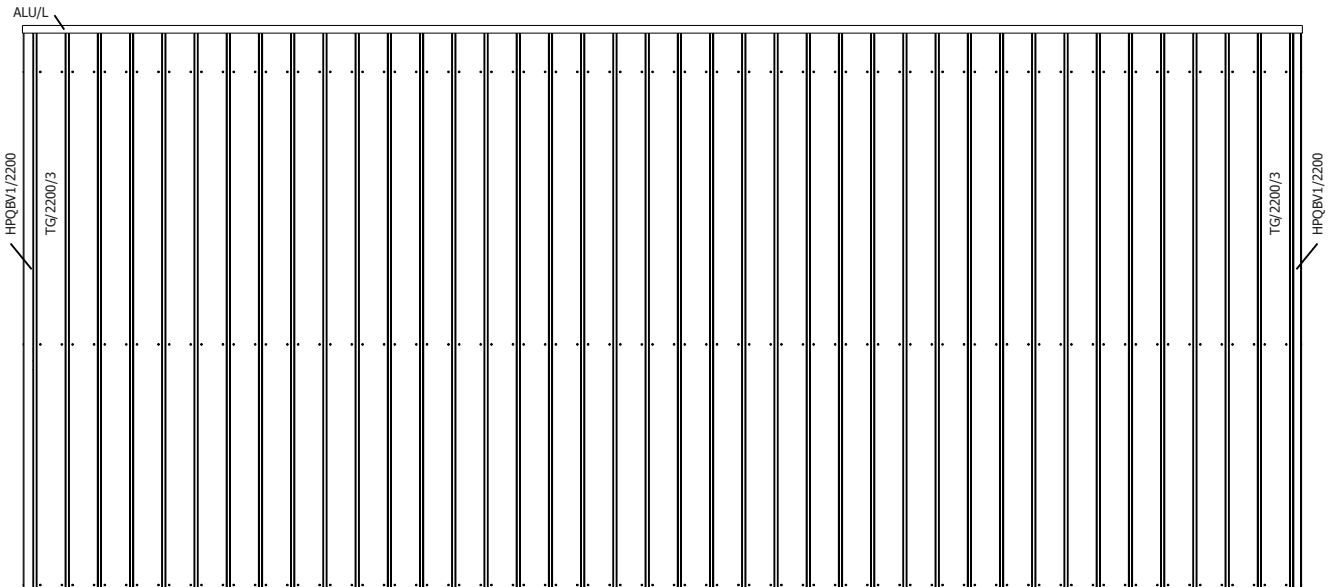



MONTAGE EXT RECHTS - A DROITE

VOORZIJDE - FACADE

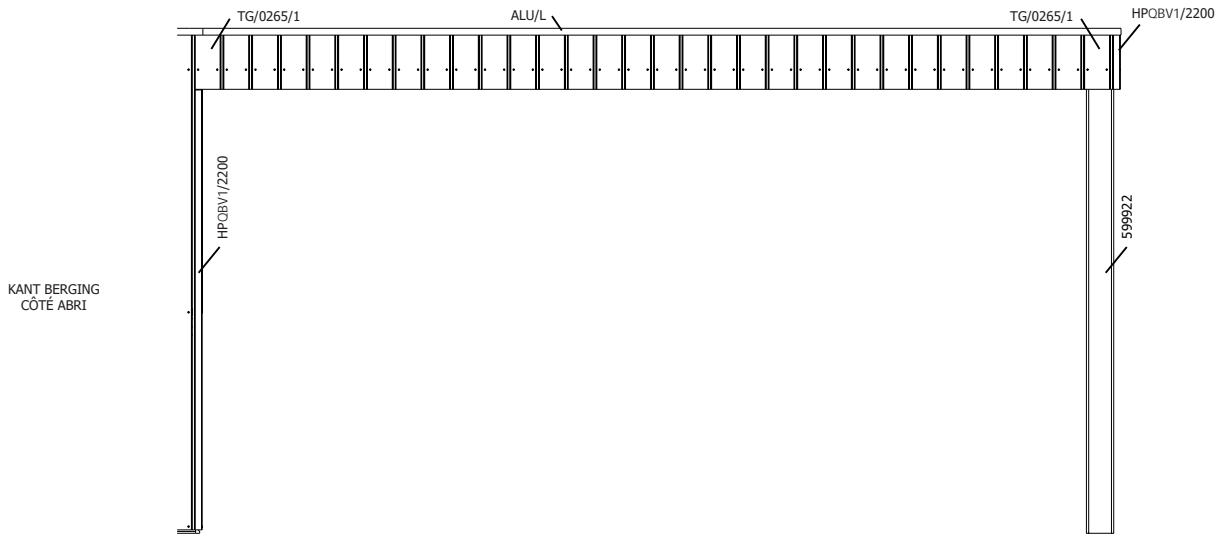

ZIJWAND - PAROI LATÉRALE

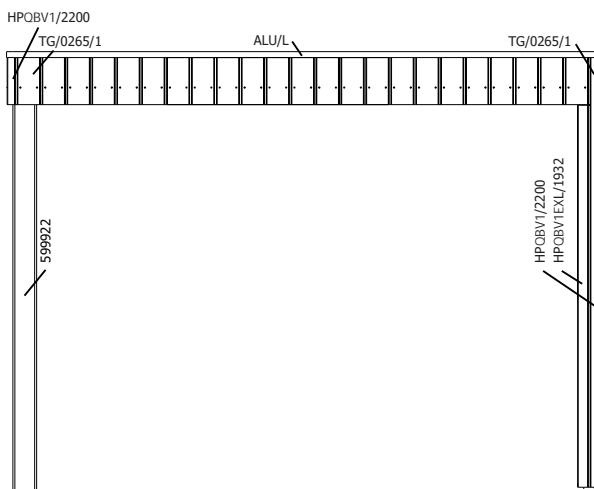

ACHTERWAND - PAROI ARRIÈRE

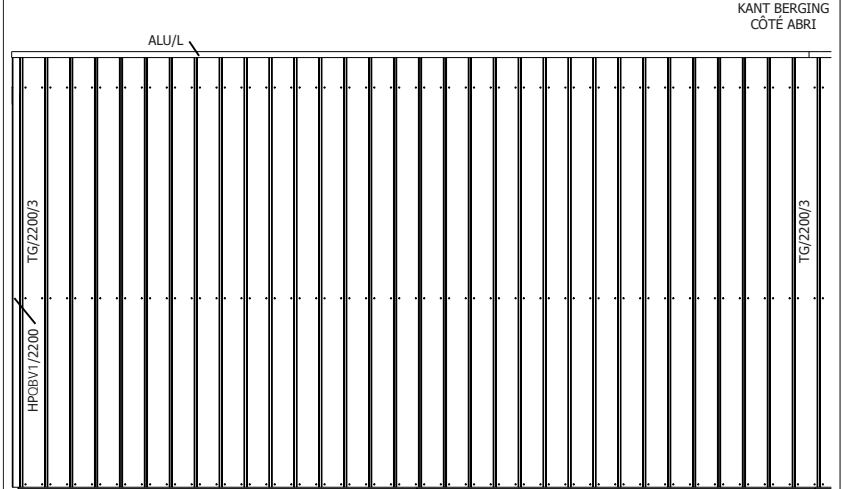

ACHTERWAND ONDER EXT- PAROI ARRIÈRE SOUS EXT

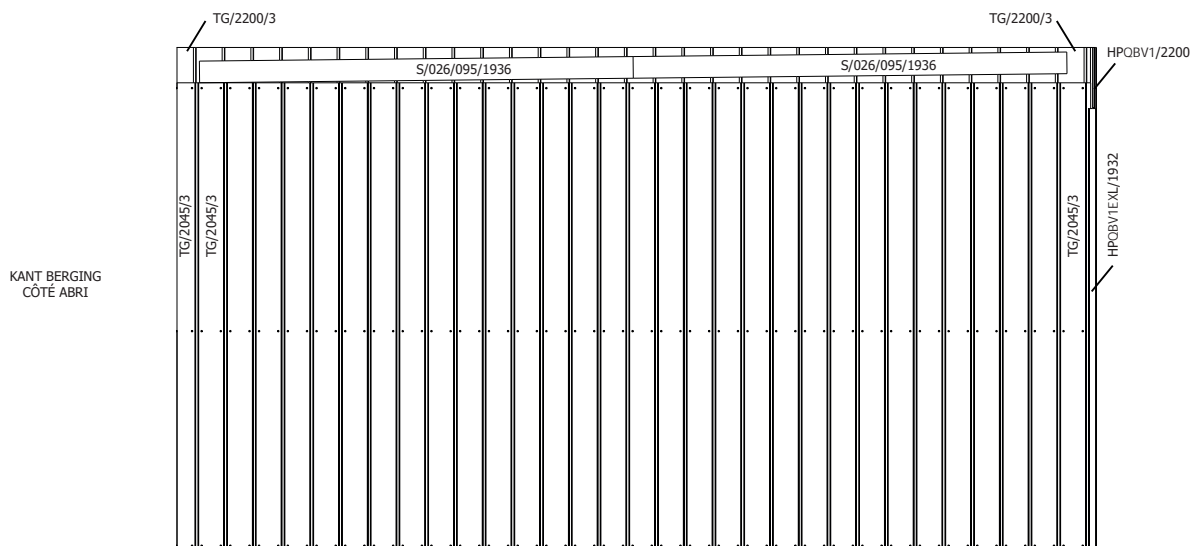

MONTAGE EXT LINKS - A GAUCHE

VOORZIJDDE - FACADE

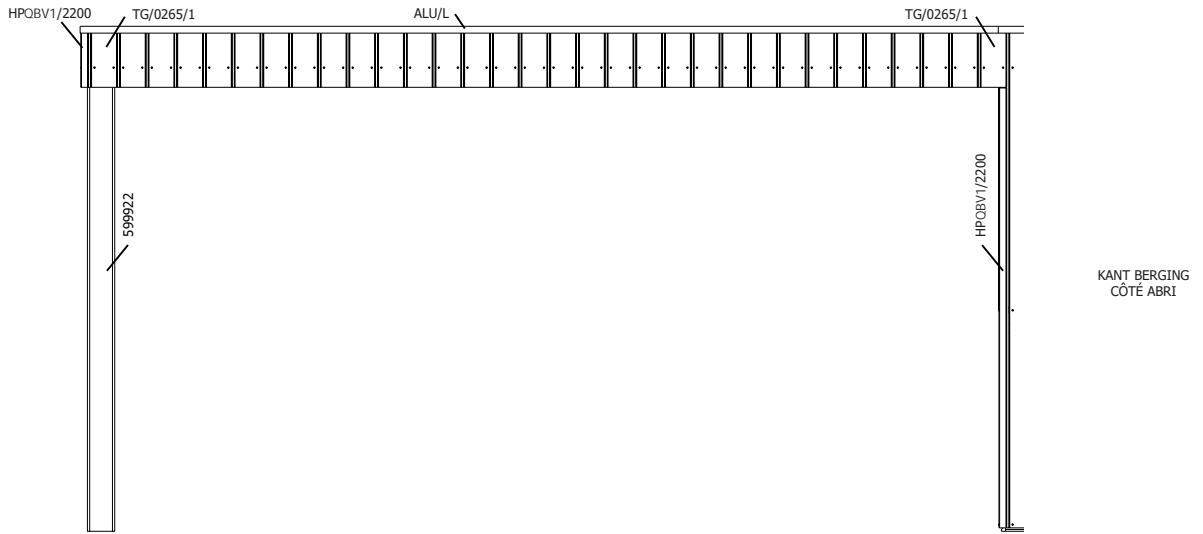

ZIJWAND - PAROI LATERALE

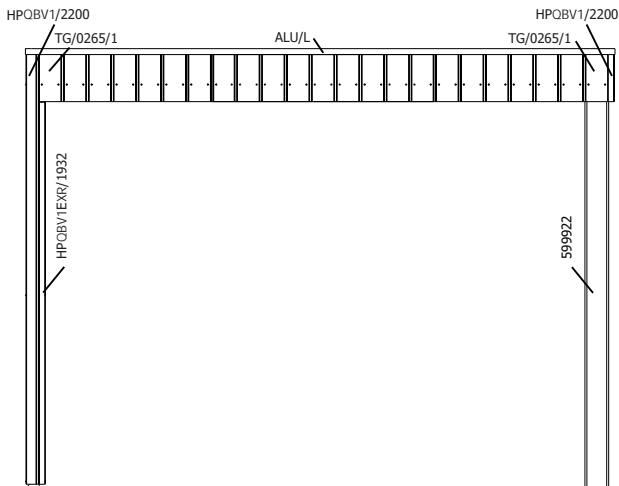

ACHTERWAND - PAROI ARRIERE

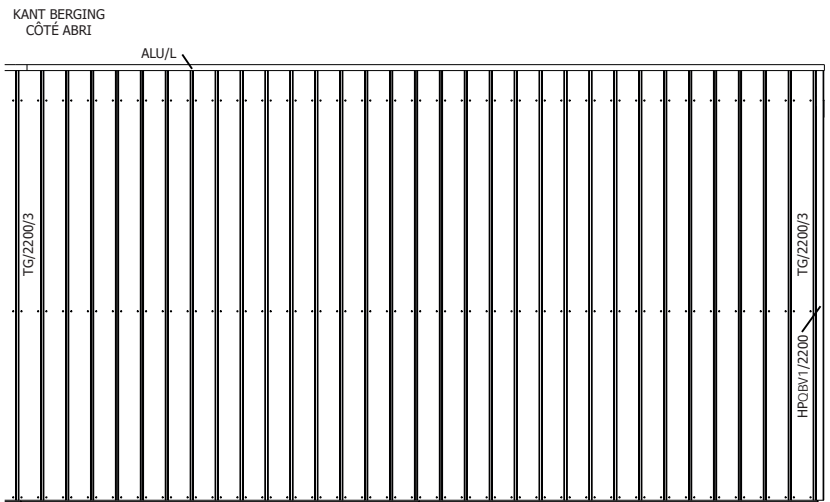

ACHTERWAND ONDER EXT- PAROI ARRIERE SOUS EXT

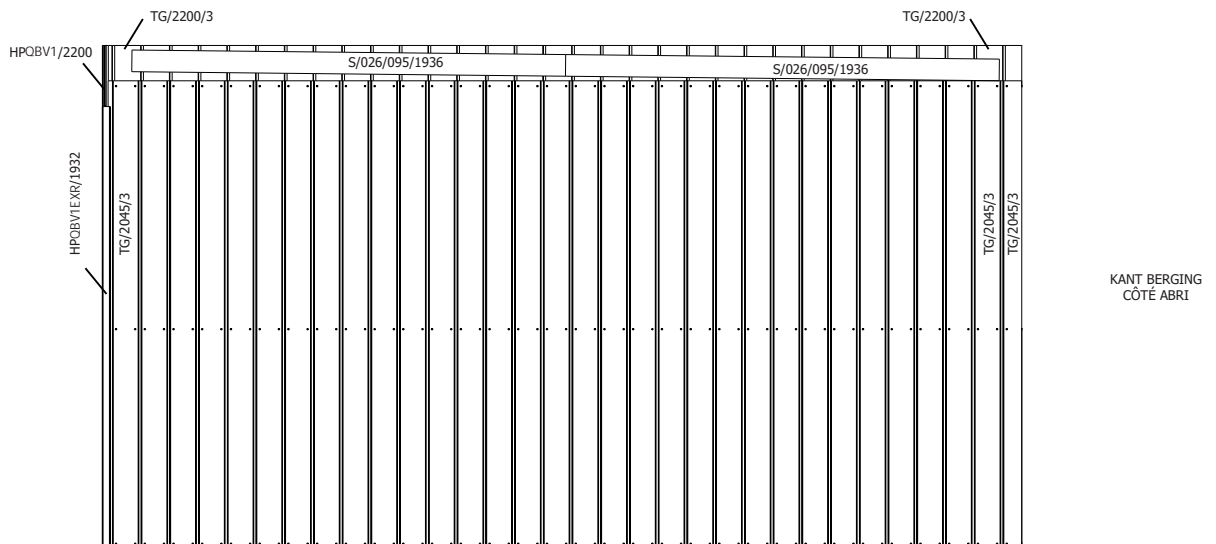

**26MM 500X298 CM QBV3 (ART 8304)**

**DAK - TOITURE**

**FRAME**

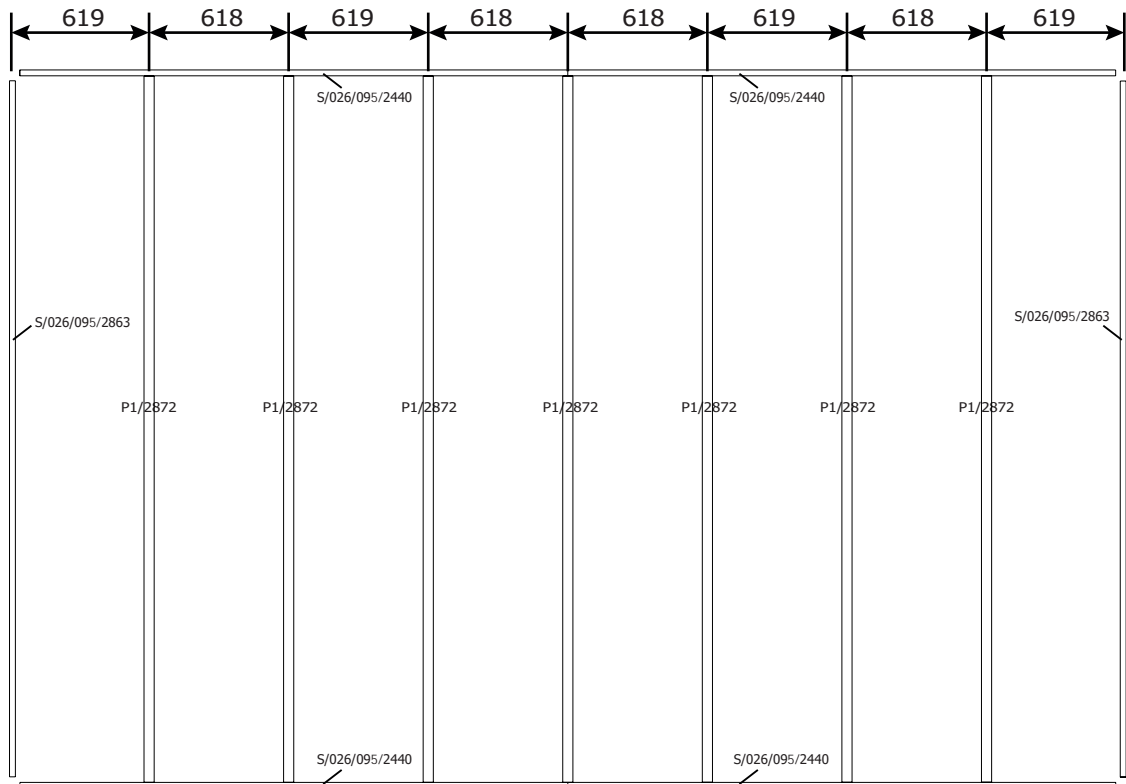

# DAK - TOITURE

## FRAME

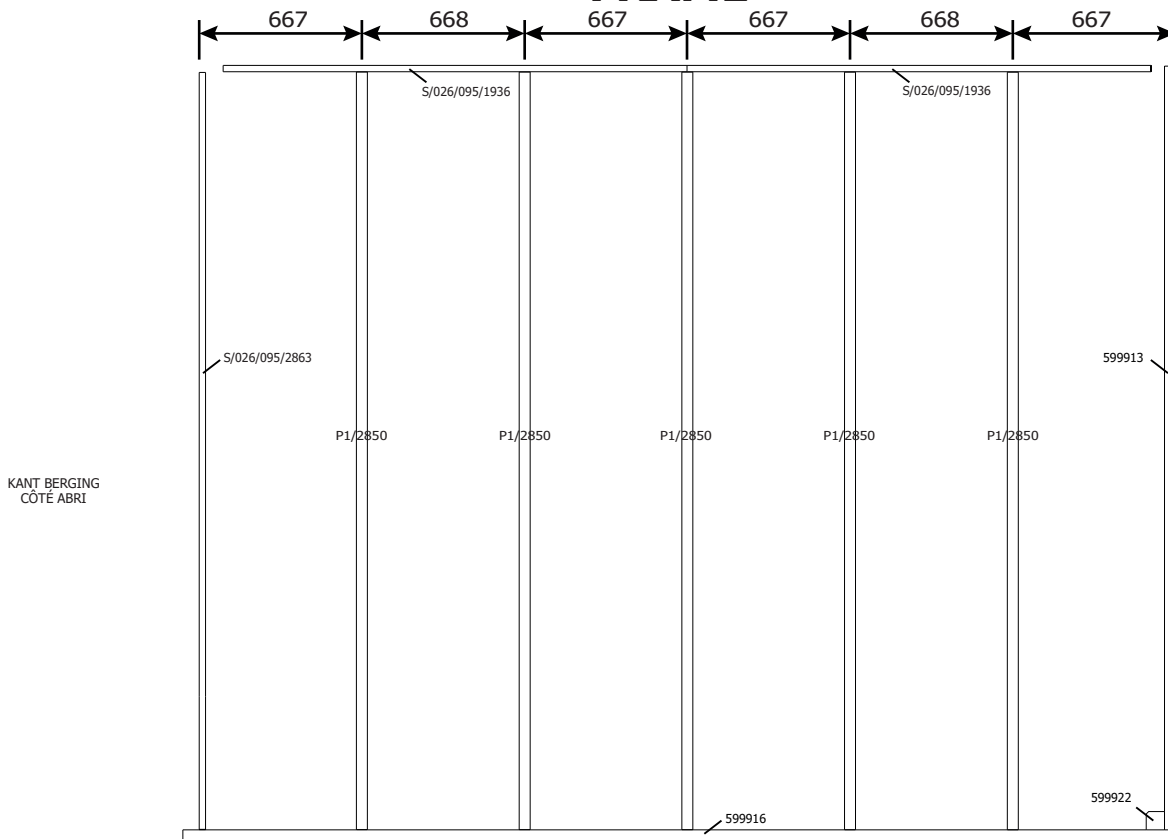

## OSB

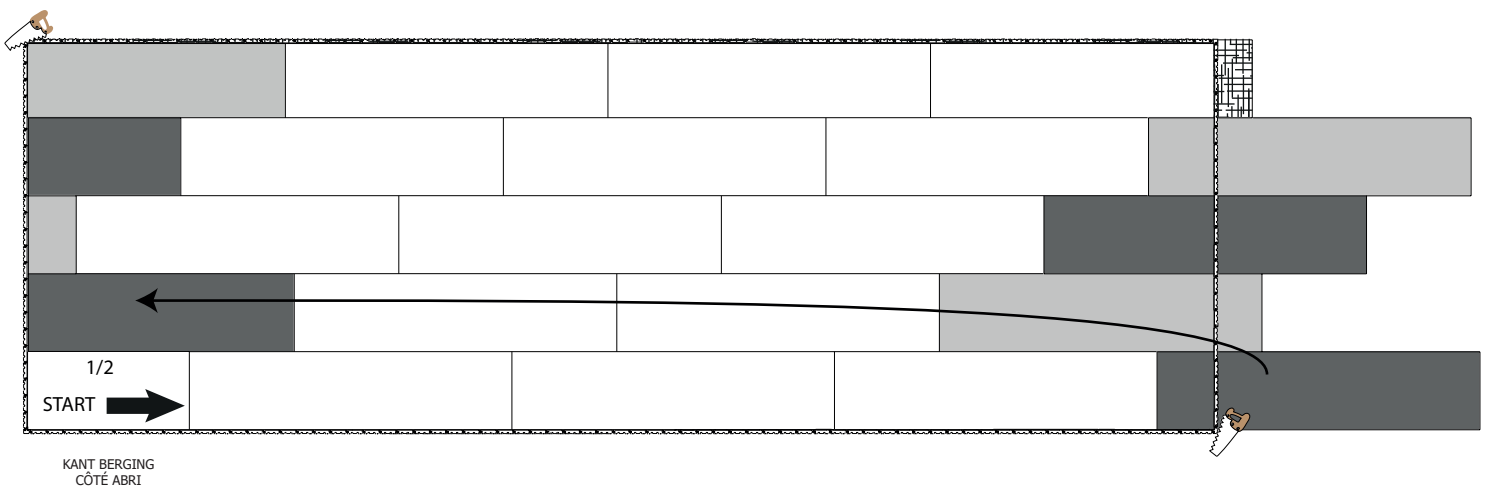
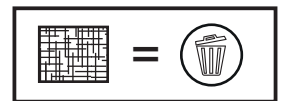

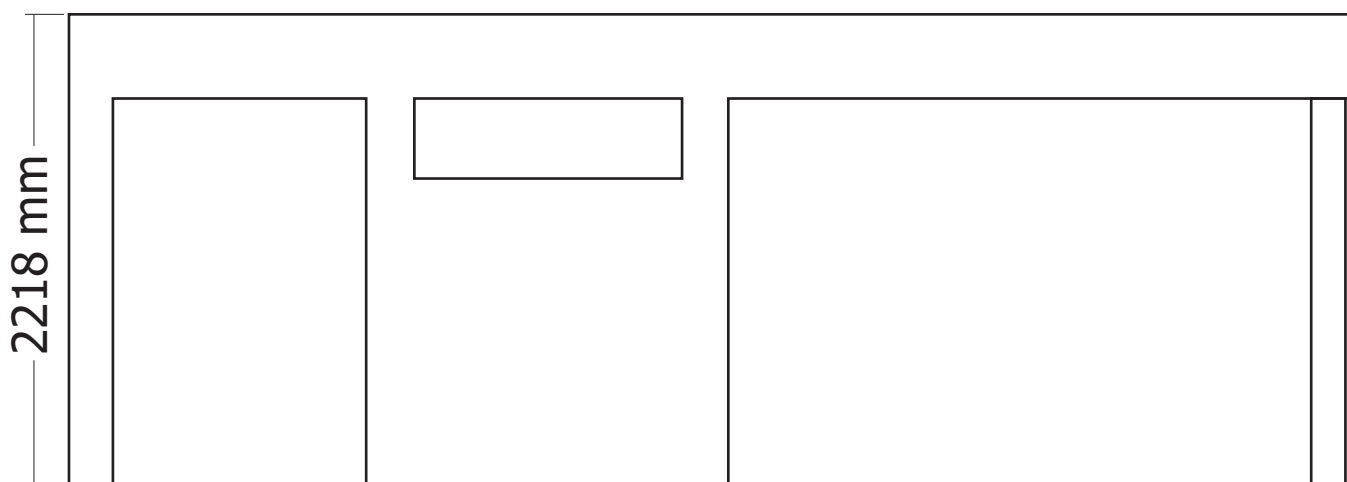
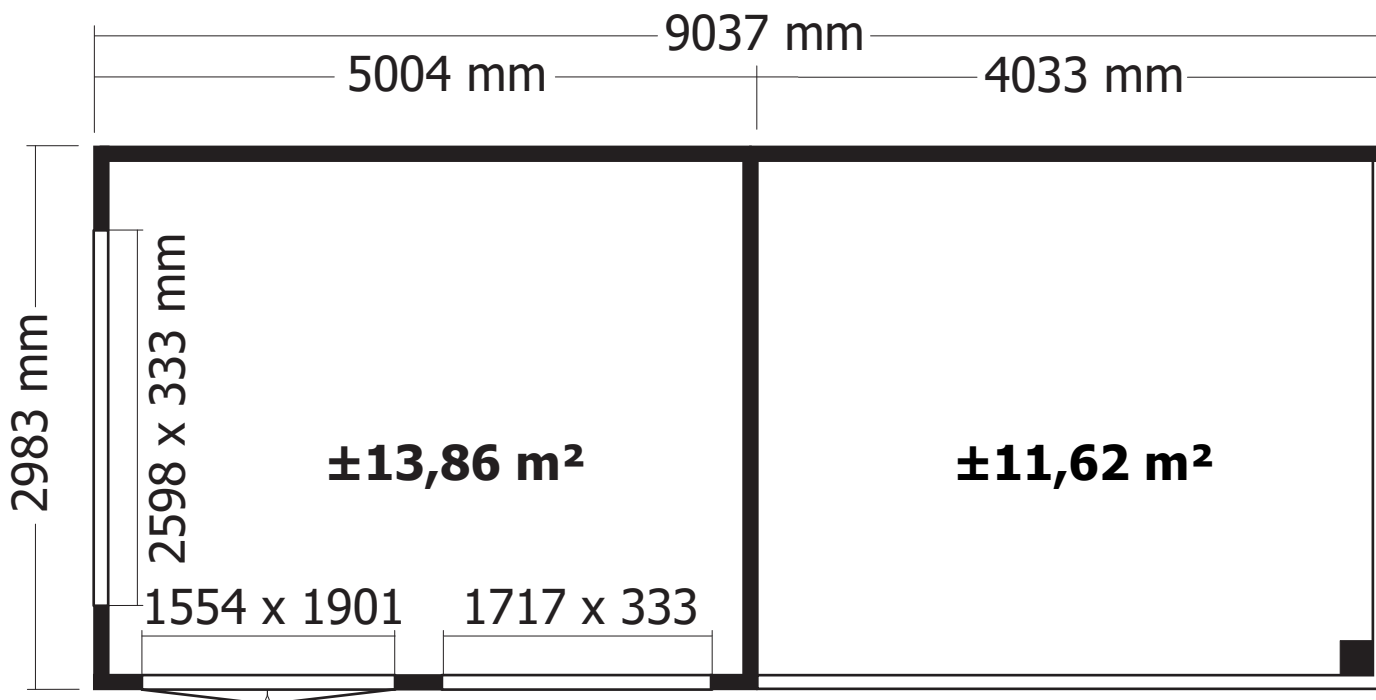

**OPGELET** : Behandel **ELK** onderdeel grondig aan alle zijden met een degelijk product dat beschermt tegen zon, weer en wind en tegen insecten en schimmels, **VOOR** de montage.

**ATTENTION** : Traitez à fond **CHAQUE** élément avec un produit protégeant contre les intempéries, les insectes et les moisissures intérieur et extérieur, **AVANT** le montage .

# Samenstellen van de kaders - Assemblage des cadres.

I.



**Opgelet, de deur zit ALTIJD LINKS!**  
**Attention, la porte se trouve TOUJOURS à GAUCHE!**

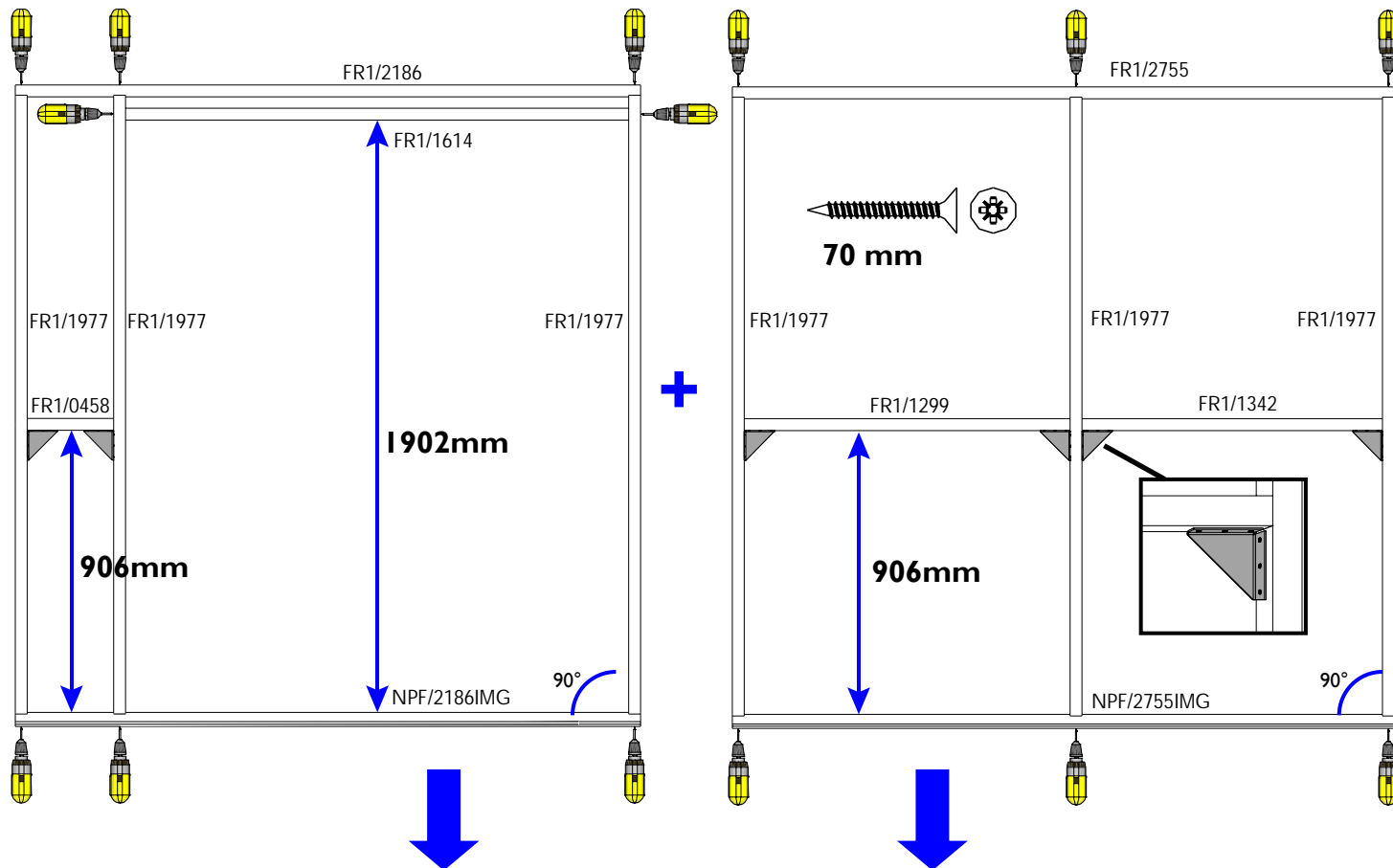

Buitenkant - Côté extérieur

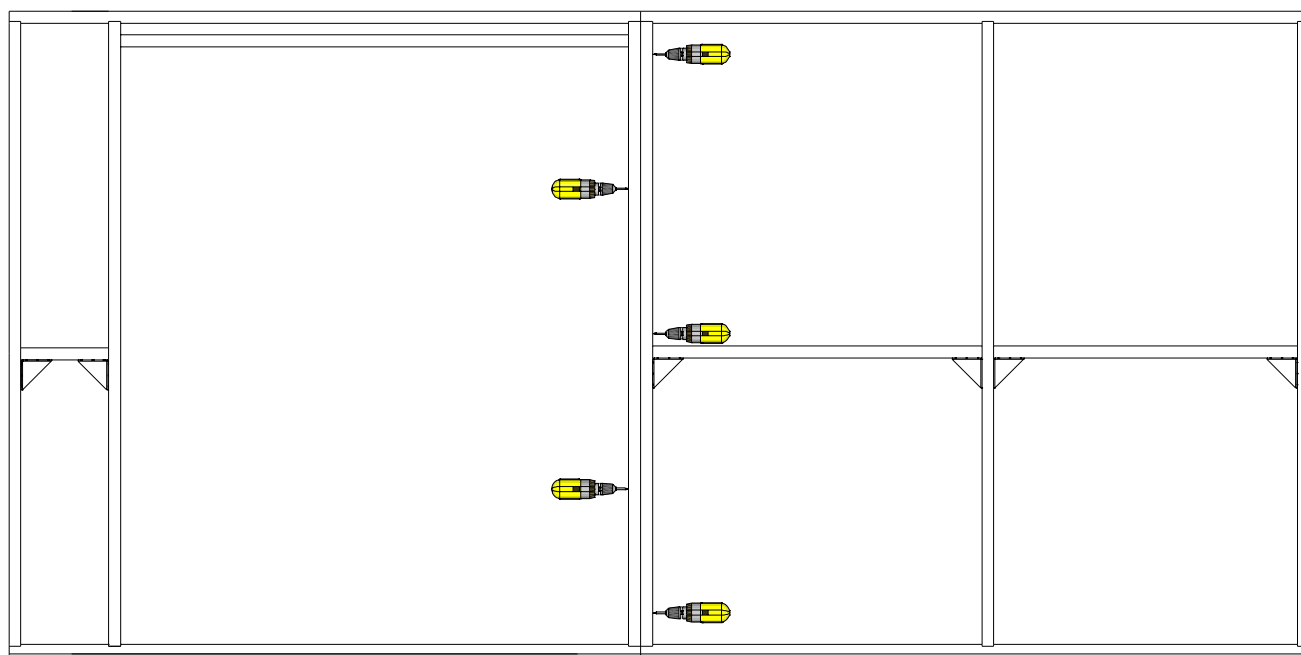
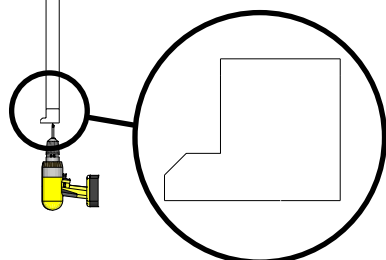

2.

## ZIJWAND - PAROI LATERALE

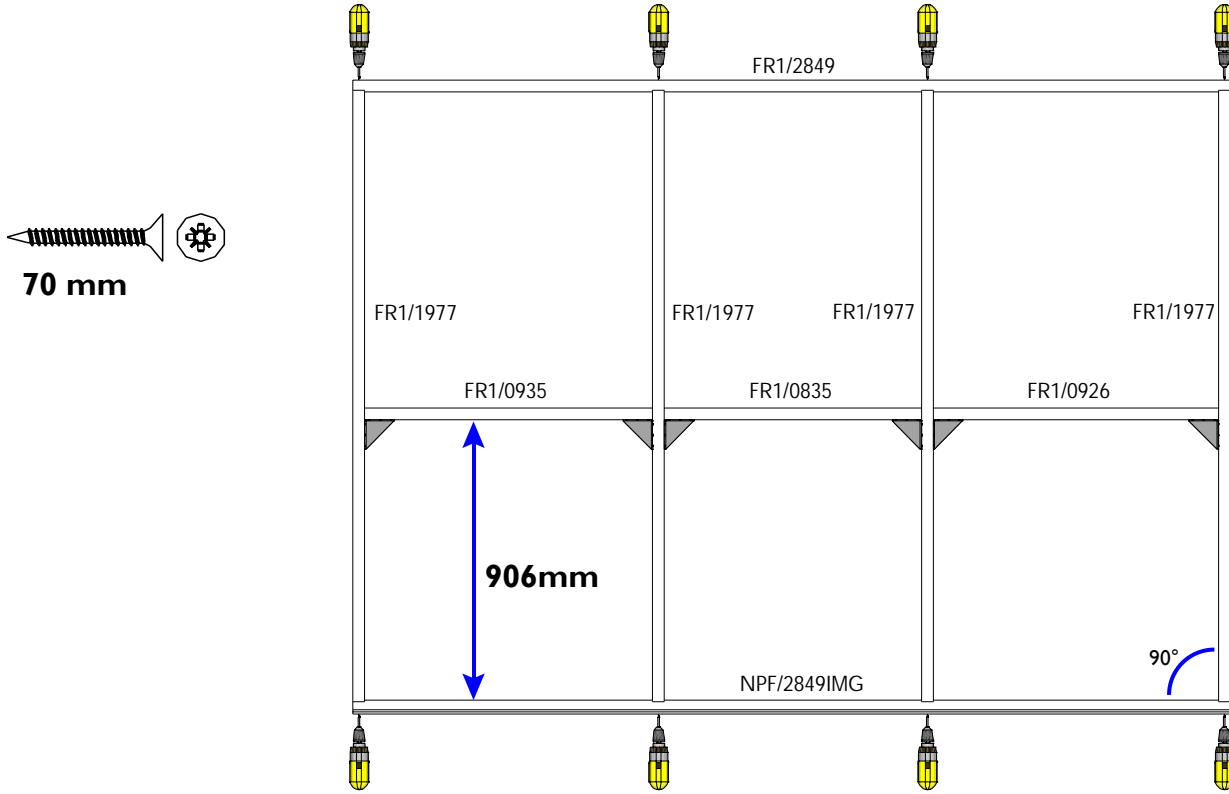

3.

## ACHTERWAND - PAROI ARRIERE

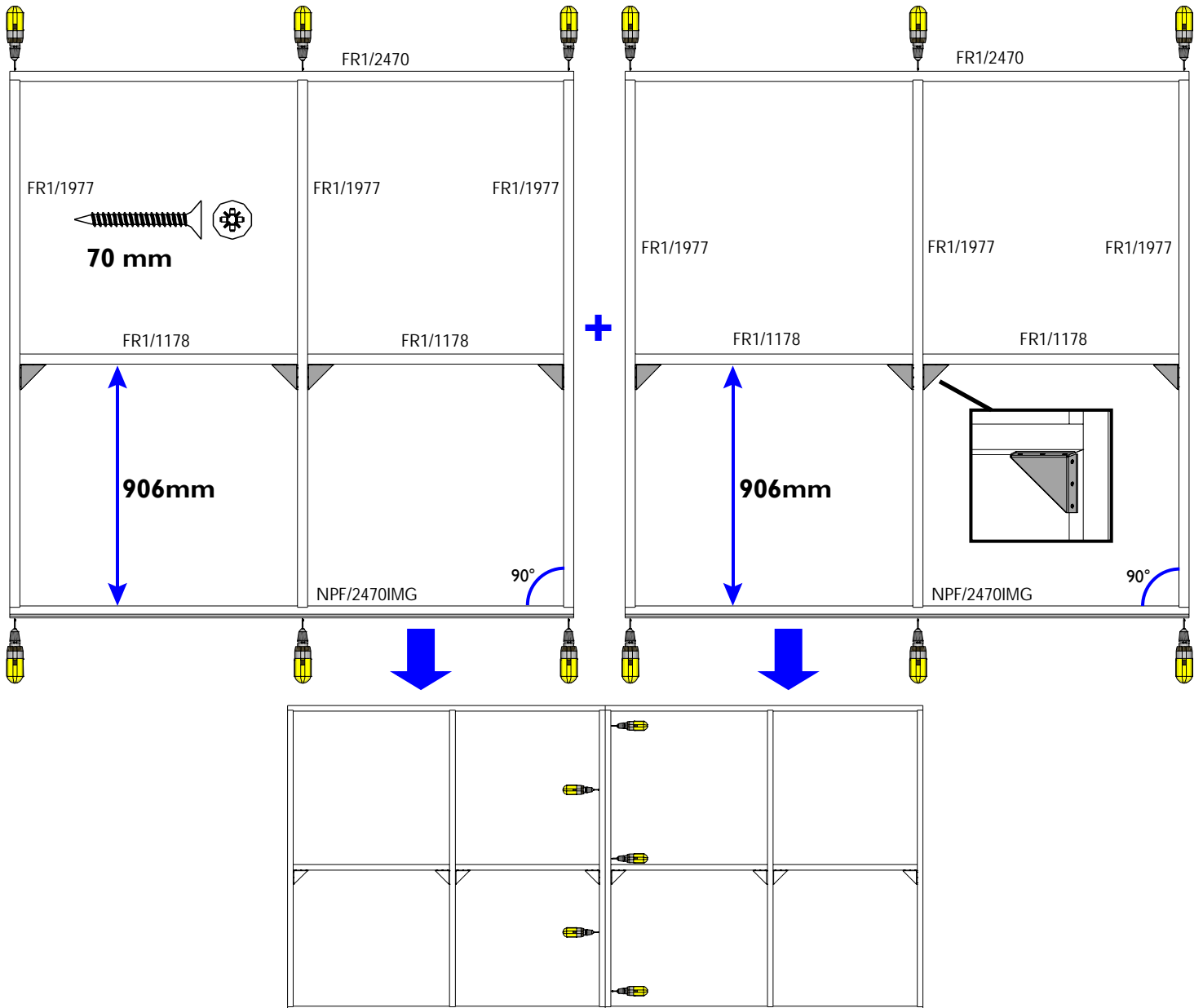

4.

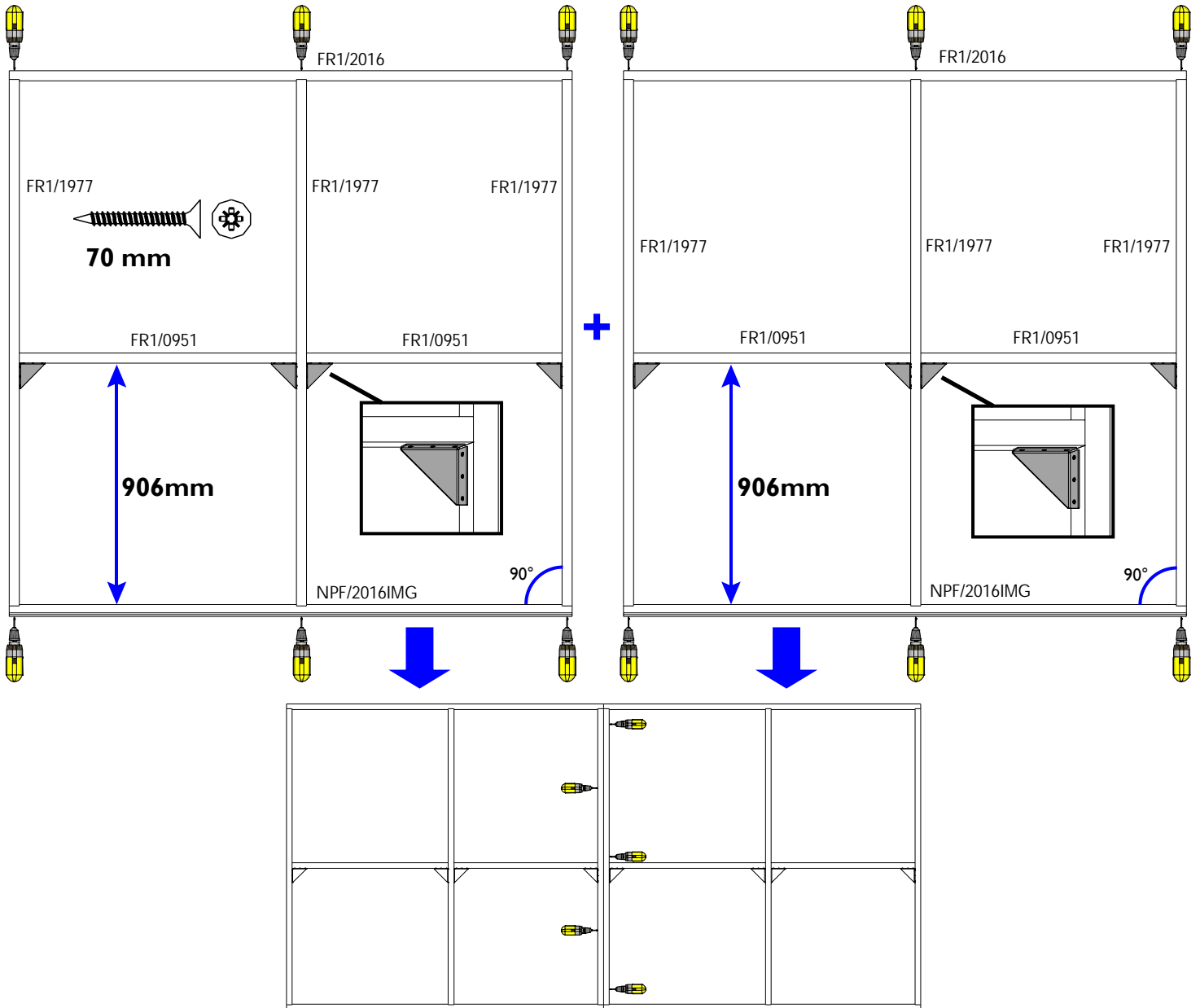



## B/8000FR5030A

aantal / nombre

Insteekslot QBV - Serrure QBV  
(Ref = 300020)



1

Scharnier zwaar - Charnière lourd (88x67)  
(Ref = 300007)

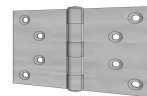

8

Balkdrager rechts - Support de poutre droite  
(Ref = 300033)

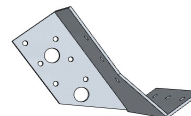

7

Balkdrager links - Support de poutre gauche  
(Ref = 300034)



7

Alu handgreep - Poignée alu  
(Ref = 304001)



1

Kantschuif bocht - Pêne  
(Ref = 300018)



2

Hoekversteving - Renfort d'angle (set 10)  
(Ref = 300022)



3

### Nagels - Clous

30mm  
(Ref = 361004)



21

### Schroeven - Vis

Zelftappende schroef - Vis auto-perceuse  
(Ref = 310002)



36

25mm  
(Ref = 310018)



363

35mm  
(Ref = 310007)



217

40mm  
(Ref = 310015)



26

50mm (Torx®)  
(Ref = 310012)



784

70mm  
(Ref = 310009)



70

### Goten - Gouttières

Bocht - Coude (90°)  
(Ref = 402006)



1

Bevestigingsbeugel - Fixation  
(Ref = 403001)



2

## B/8000FRAB4030

aantal / nombre

Balkdrager rechts - Support de poutre droite  
(Ref = 300033)

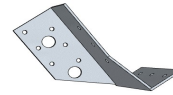

5

Balkdrager links - Support de poutre gauche  
(Ref = 300034)



5

Hoekversteving - Renfort d'angle (set 10)  
(Ref = 300022)



1

Hoekijzer klein - Equerre petit (30x30x30)  
(Ref = 300026)

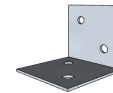

4

### Schroeven - Vis

Zelftappende schroef - Vis auto-perceuse  
(Ref = 310002)



18

25mm



220

(Ref = 310018)

35mm



133

(Ref = 310007)

40mm



13

(Ref = 310015)

50mm (Torx®)



494

(Ref = 310012)

70mm



22

(Ref = 310009)

90mm



8

(Ref = 310004)

100mm



10

(Ref = 310005)