

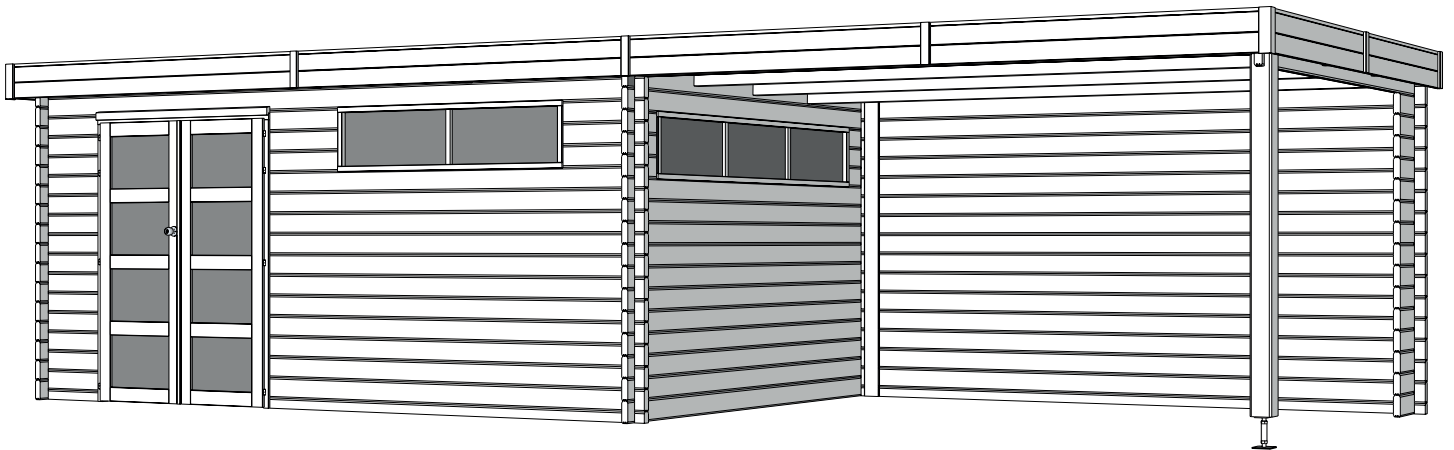

# WOODLANDS

QUALITY CABINS



## GEDETAILEERDE ONDERDELENLIJST - LISTE D'INVENTAIRE DETAILLEE

Download uw montage instructies op [www.gardenas.be](http://www.gardenas.be)

Téléchargez vos instructions de montage sur [www.gardenas.be](http://www.gardenas.be)

# Onderdelenlijst Liste d'inventaire

## Typ **44mm 505x295 cm PDDDM04**

### 4601AC/ISO

Artikel nr / Nr Article      Afmeting / Dimension      #      Functie / Fonction  
A      B      C

#### Wandelementen / Éléments des parois

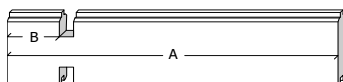

Z1/2950/0070	2950	70	(-)	<b>11</b>	onder raam voorgevel / sous fenêtre façade
Z1/0608/0070	608	70	(-)	<b>17</b>	naast deur en raam voorgevel / côté porte et fenêtre façade
Z1/0315/0070	315	70	(-)	<b>6</b>	naast raam zijgevel / côté fenêtre paroi latérale

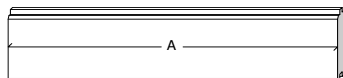

Z2/0607	607	(-)	(-)	<b>3</b>	tussen raam & deur voorgevel / entre fenêtre & porte façade
---------	-----	-----	-----	----------	---

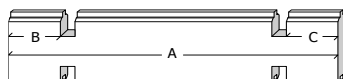

Z3/5050/0070/0070	5050	70	70	<b>16</b>	achter- & voorgevel / façade et paroi arrière
Z3/2950/0070/0070	2950	70	70	<b>27</b>	zijgevel / paroi latérale

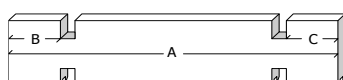

Z5/5050/0070/0070	5050	70	70	<b>1</b>	bovenste plank voorgevel / planche supérieure façade
-------------------	------	----	----	----------	--

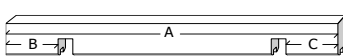

Z0/5050/QQ001	5050	70	70	<b>1</b>	bovenste plank achtergevel / planche supérieure paroi arrière
---------------	------	----	----	----------	---

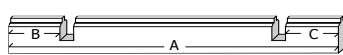

Z7/5050/0070/0070	5050	70	70	<b>2</b>	basis voor- & achtergevel / base paroi avant et arrière
-------------------	------	----	----	----------	---

#### Dakelementen / Éléments du toit



ZK/P2/3075/3/2/R	3075	195	70	<b>1</b>	helling rechts / pente droite
------------------	------	-----	----	----------	-------------------------------



ZK/P2/3075/3/2/L	3075	195	70	<b>1</b>	helling links / pente gauche
------------------	------	-----	----	----------	------------------------------

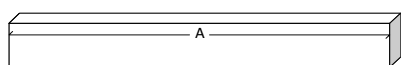

HDB/SET10				<b>1</b>	zak balkjes + sierlatjes / sachet poutres + lattes de finitions
P2/4880	4880	145	44	<b>3</b>	dakbalk / poutre du toit

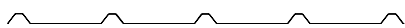

PPD1AC/3175/1000	3175	1000	(-)	<b>5</b>	profielplaten / panneaux profilés
------------------	------	------	-----	----------	-----------------------------------

#### Afwerkingselementen / Éléments de finition

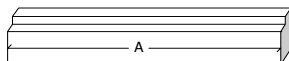

SRD/1522	1522	(-)	(-)	<b>2</b>	sierlat boven deurkader / latte de finition cadre de porte
----------	------	-----	-----	----------	--

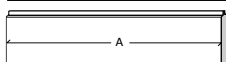

FSLMA/2540/115	2540	115	(-)	<b>2</b>	frontale sierlat tand / latte de finition frontale languette
FSLMB/2540/108	2540	108	(-)	<b>2</b>	frontale sierlat groef / latte de finition frontale rainure

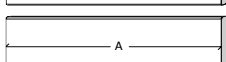

FSLMA/3230/115	3230	115	(-)	<b>2</b>	zij sierlat tand / latte de finition latérale languette
FSLMB/3230/108	3230	108	(-)	<b>2</b>	zij sierlat groef / latte de finition latérale rainure

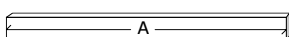

SSL45/2700	2700	(-)	(-)	<b>2</b>	stormsierlat op het dak (voorkant) / latte de finition sur le toit (façade)
SSL45/3300	3300	(-)	(-)	<b>2</b>	stormsierlat op het dak (zijkant) / latte de finition sur le toit (latérale)
M/1920	1920	(-)	(-)	<b>1</b>	makelaar deur / latte de cache porte

DDM04-S/PLXM				<b>1</b>	opdeur modern voor slot / porte modern à recouvrement serrure
DDM04-V/PLXM				<b>1</b>	opdeur modern vast / porte modern à recouvrement fixe
X/DDO	(3 delen / 3 pièces)			<b>1</b>	kader 44mm voor dubbele opdeur / cadre 44mm pour porte double à recouvrement

X/VRM2L/PLXM				<b>1</b>	vast raam 2 delig / fenêtre fixe 2 parties
--------------	--	--	--	----------	--

X/VRM3K/PLXM				<b>1</b>	vast raam 3 delig / fenêtre fixe 3 parties
--------------	--	--	--	----------	--

B/4601AC				<b>1</b>	zak beslag / sachet quincaillerie
----------	--	--	--	----------	-----------------------------------

# Onderdelenlijst Liste d'inventaire

## Typ **44mm 400x295 cm EXTPD**

### 4600AB4030

Artikel nr / Nr Article      Afmeting / Dimension      #      Functie / Fonction

#### Wandelementen / Éléments des parois

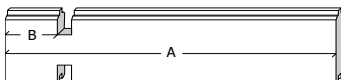

Z1/0425/0070	425	70	(-)	<b>15</b>	zijgevel extensie / paroi latéral extension
Z1/3955/0070	3955	70	(-)	<b>15</b>	achtergevel extensie / paroi arrière extension

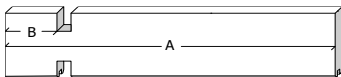

Z5/4070/0070	4070	70	(-)	<b>1</b>	bovenste plank voorgevel extensie / planche supérieure façade extension
--------------	------	----	-----	----------	---

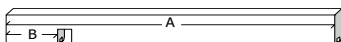

Z0/4070/0070	4070	70	(-)	<b>1</b>	bovenste plank achtergevel ext / planche supérieure paroi arrière ext
--------------	------	----	-----	----------	---

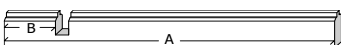

Z7/3955/0070	3955	70	(-)	<b>1</b>	basis achtergevel extensie / base paroi arrière extension
--------------	------	----	-----	----------	---

#### Dakelementen / Éléments du toit



ZK/P2/3075	3075	195	70	<b>1</b>	helling / pente
------------	------	-----	----	----------	-----------------

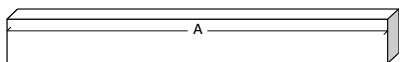

599937	1909	(-)	(-)	<b>1</b>	paal / poteau
HDB/SET9				<b>1</b>	zak balkjes + sierlatjes / sachet poutres + lattes de finitions
P2/3956	3956	145	44	<b>3</b>	dakbalk / poutre du toit



300035	290	120	120	<b>1</b>	U-anker / U-socle
--------	-----	-----	-----	----------	-------------------



PPD1AC/3175/1000	3175	1000	(-)	<b>4</b>	profielplaten / panneaux profilés
------------------	------	------	-----	----------	-----------------------------------

#### Afwerkingselementen / Éléments de finition

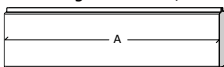

FSLMA/4080/115	4080	115	(-)	<b>1</b>	frontale sierlat tand / latte de finition frontale languette
FSLMB/4080/108	4080	108	(-)	<b>1</b>	frontale sierlat groef / latte de finition frontale rainure



**te zagen op lengte 4000 mm / à scier sur longueur 4000 mm**

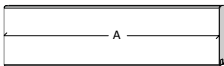

S/045/045/2010	2010	45	45	<b>1</b>	balkje verbinding achterwand / poutrelle connection par. arrière
SSL45/4200	4200	(-)	(-)	<b>1</b>	stormsierlat op het dak (voorkant) / latte de finition sur le toit (façade)

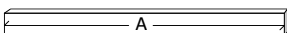

FSL/2100	2100	(-)	(-)	<b>1</b>	sierlat verbinding achterwand / latte de finition connection par. arrière
----------	------	-----	-----	----------	---

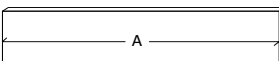

599906	2100	(-)	(-)	<b>1</b>	sierlat verbinding achterwand / latte de finition connection par. arrière
--------	------	-----	-----	----------	---

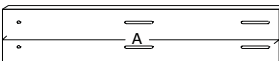

B/4600AB				<b>1</b>	zak beslag / sachet quincaillerie
----------	--	--	--	----------	-----------------------------------

# 44MM 505X295 CM (ART 4601AC/ISO)

## VOORZIJDDE - FACADE

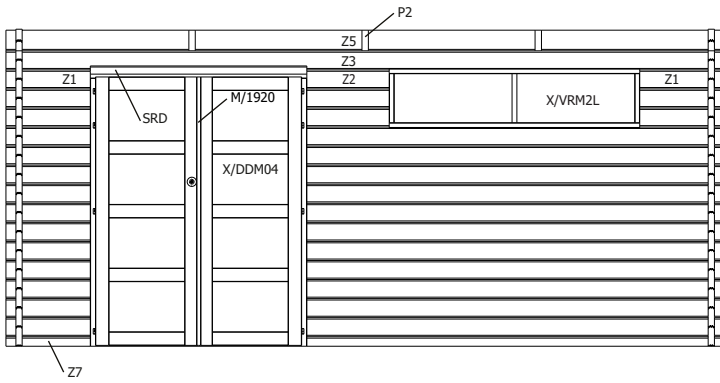

## RUGZIJDDE - PAROI ARRIERE

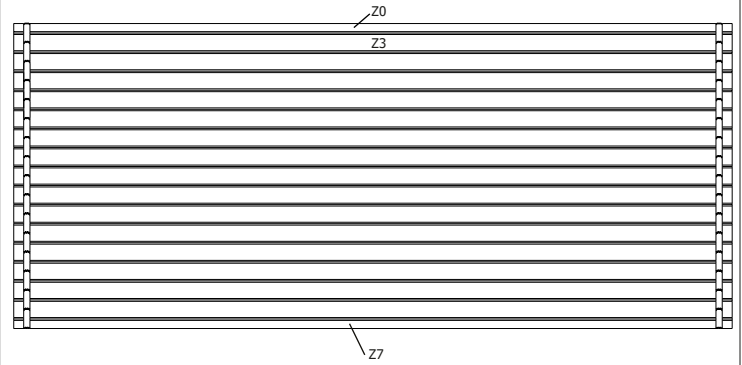

## ZIJWAND - PAROI LATERALE

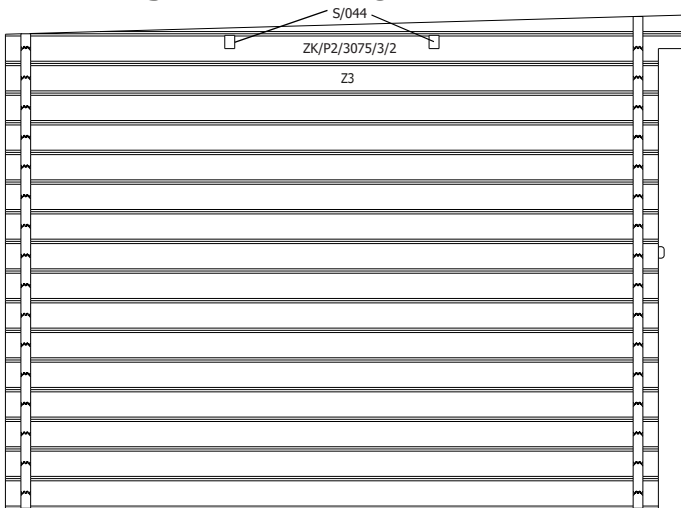

## ZIJWAND - PAROI LATERALE

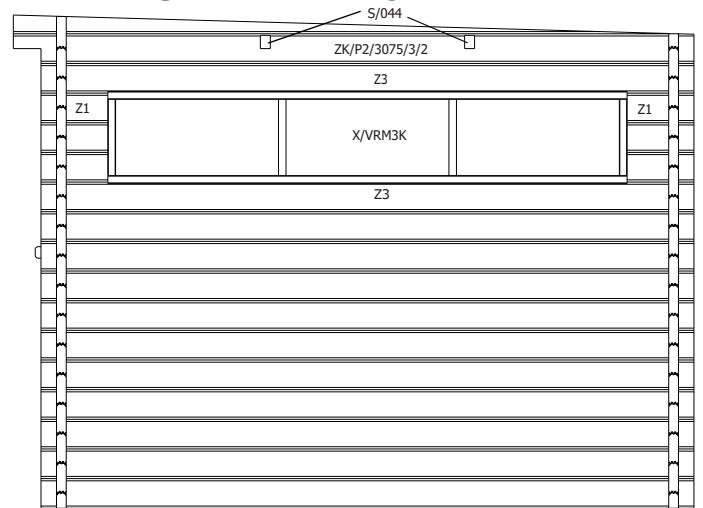

## DAK - TOITURE

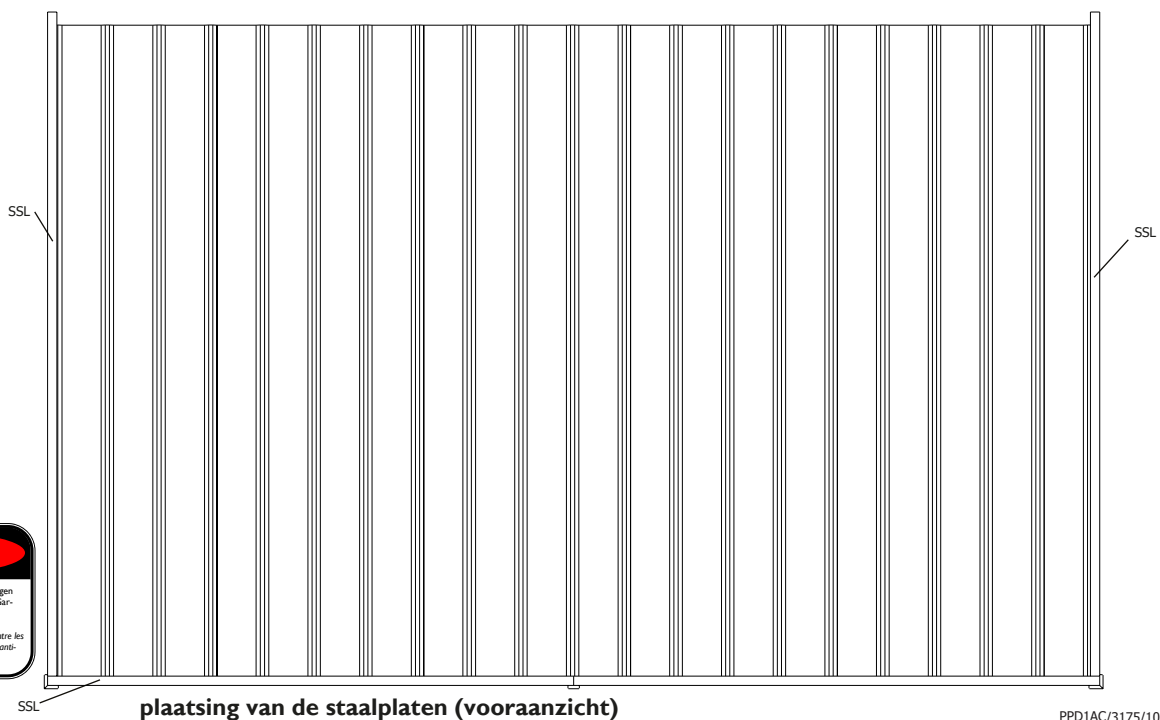

pose du toit en tôle (vue de face)

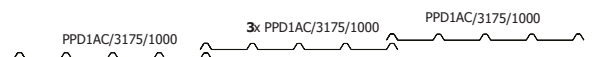

# 44MM 400X295 CM EXTPD (ART 4600AB4030AC/ISO)

## ZIJAANZICHT - VUE LATERALE

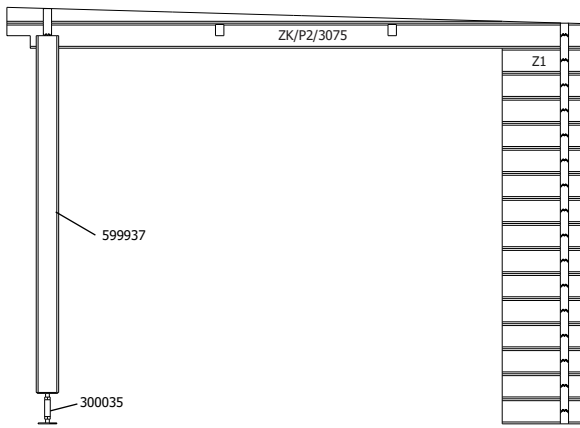

## VOORZIJDJE - FACADE

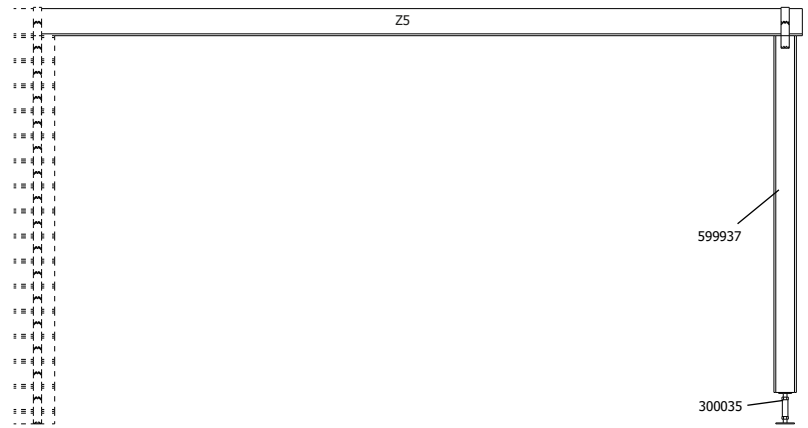

## ACHTERZIJDJE - VUE ARRIERE

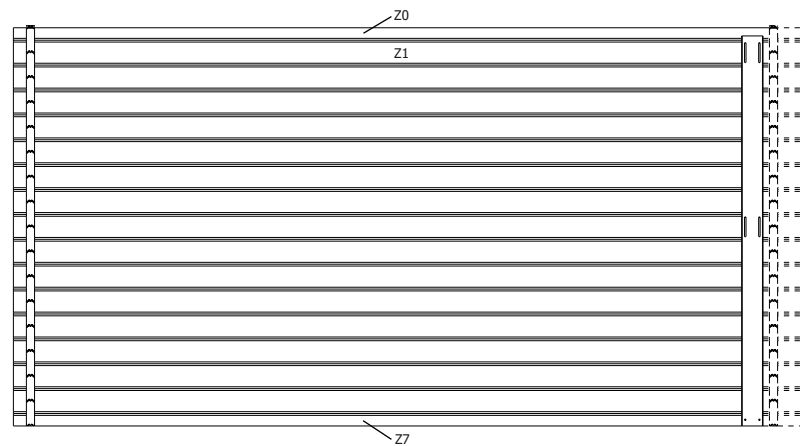

## DAK - TOITURE

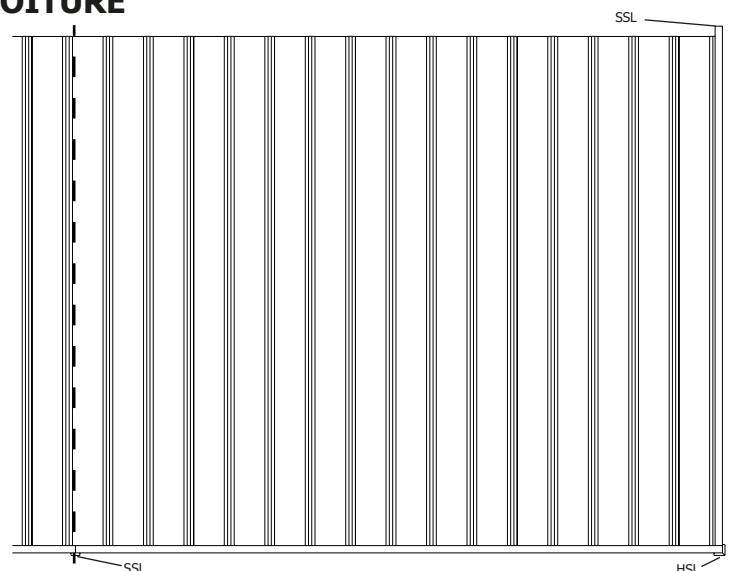
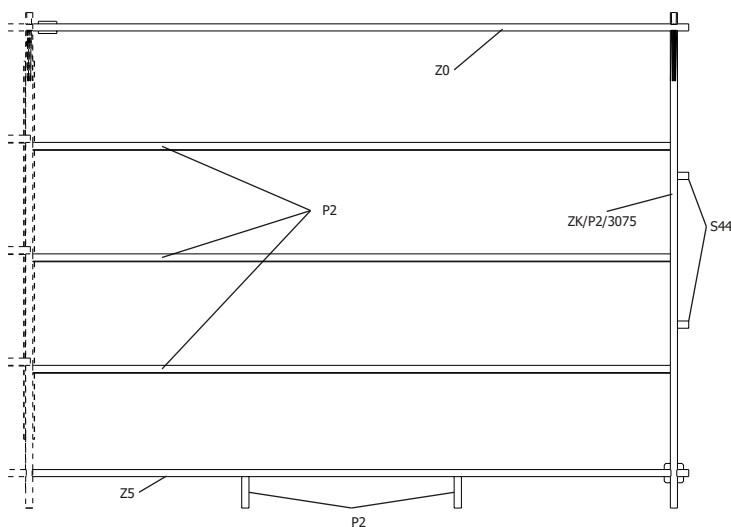

### plaatsing van de staalplaten (vooraanzicht) - pose du toit en tôle (vue de face)

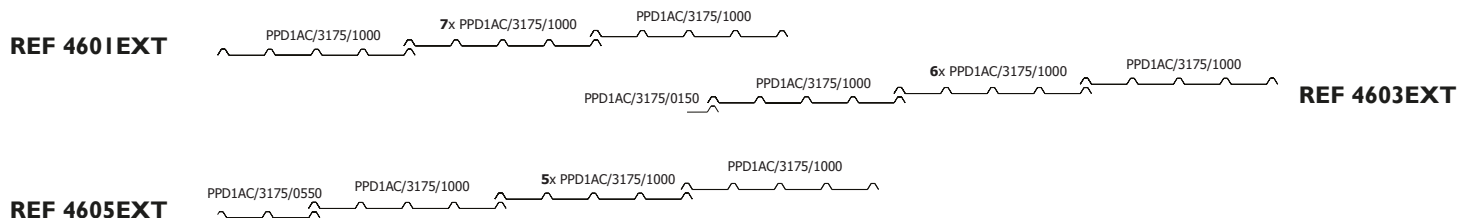

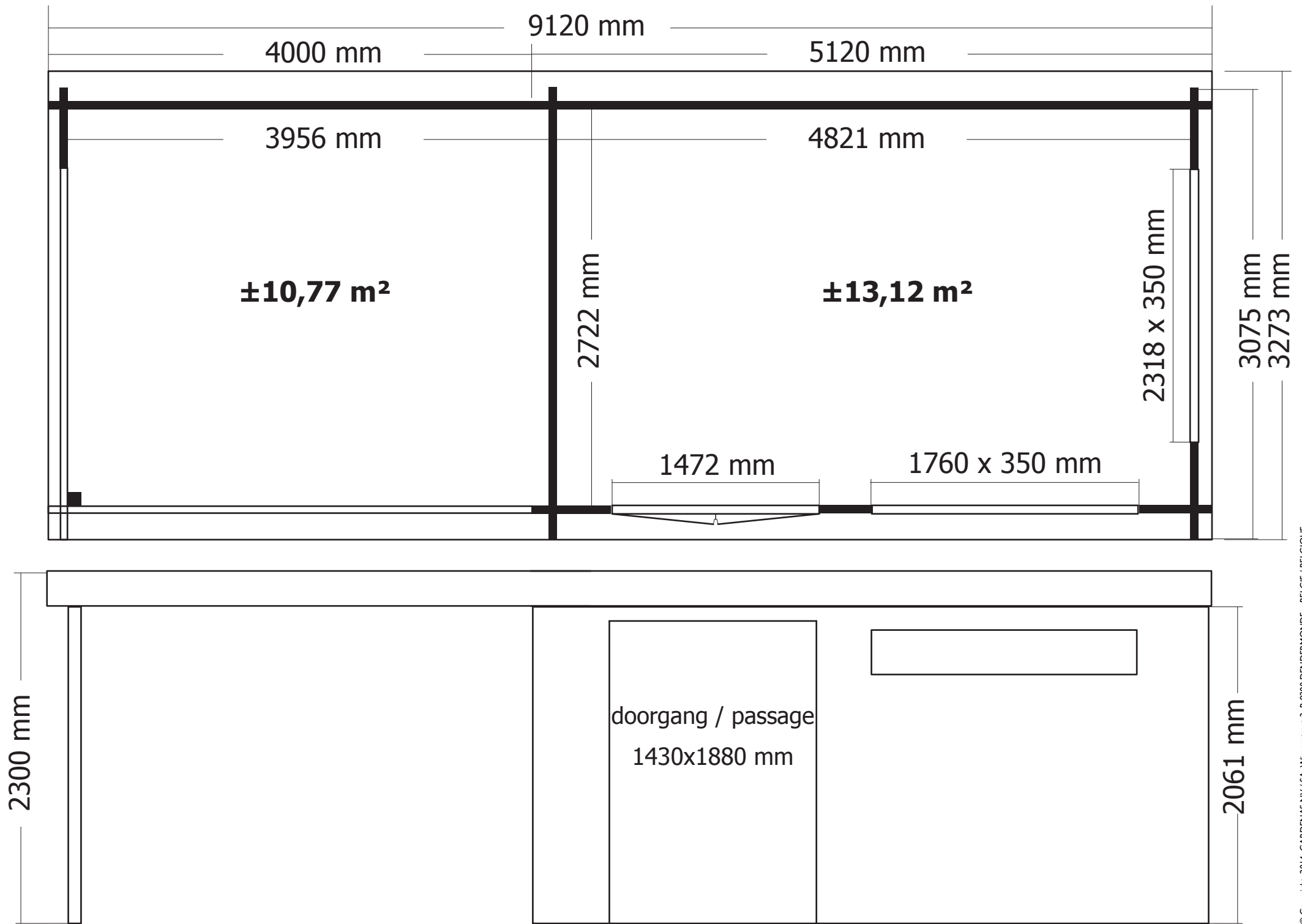

## B/4601AC

aantal / nombre

Slot - Serrure (knoblock 28-45mm)  
(Ref = 333005)

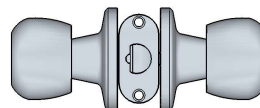

1

Scharnier paumelle groot - Charnière paumelle grand  
(Ref = 300014)

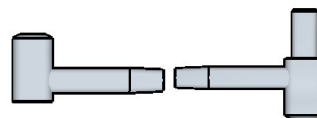

8 set

Kantschuif - Pêne (120mm)  
(Ref = 300019)



2

Hoekijzer groot - Equerre grand (60x60x40)  
(Ref = 300024)

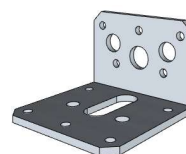

2

### Schroeven - Vis

25mm  
(Ref = 310018)



33

35mm  
(Ref = 310007)



30

50mm  
(Ref = 310013)



26

70mm  
(Ref = 310009)



18

100mm  
(Ref = 310005)

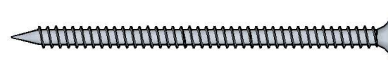

12

Schroef + kapje - Vis + capuchon (100mm)  
(Ref = 310005 & 399007)

95

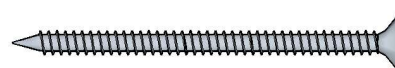

## B/4600AB

Rondel - Rondelle (M8)  
(Ref = 330001)

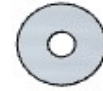

aantal / nombre

10

Houtdraadbout - Boulon (8x40)  
(Ref = 340002)



10

### Schroeven - Vis

25mm  
(Ref = 310018)

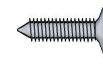

10

35mm  
(Ref = 310007)



20

50mm  
(Ref = 310013)



16

70mm  
(Ref = 310009)



8

100mm  
(Ref = 310005)

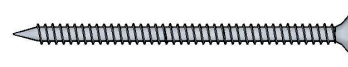

28

Schroef + kapje - Vis + capuchon (100mm)  
(Ref = 310005 & 399007)

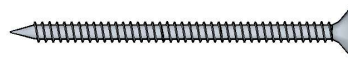

65



# HDB/SET10

Voor artikel / Pour article:

4601

4603

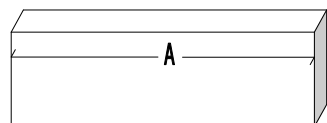

ARTIKEL NR

NR ARTICLE

P2/0195

S/044/060/0070

AANTAL

NOMBRE

3

4

FUNCTIE

FONCTION

hulpdakbalk / poutre de toit d'aide

hulpdakbalk / poutre de toit d'aide



SSL/0230

HSL/0230

7

4

sierlat / latte de finition

sierlat hoek / latte de finition coin

# HDB/SET9

**Voor artikel / Pour article:**

4600AB4030

4600AB4040

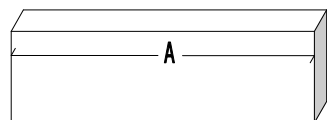

<u>ARTIKEL NR</u>	<u>AANTAL</u>	<u>FUNCTIE</u>
<u>NR ARTICLE</u>	<u>NOMBRE</u>	<u>FONCTION</u>
P2/0195	2	hulpdakbalk / poutre de toit d'aide

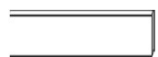

SSL/0230	2	sierlat / latte de finition
----------	---	-----------------------------