

44MM 415+400X295 CM (ART 4603EXT400AC/ISO)

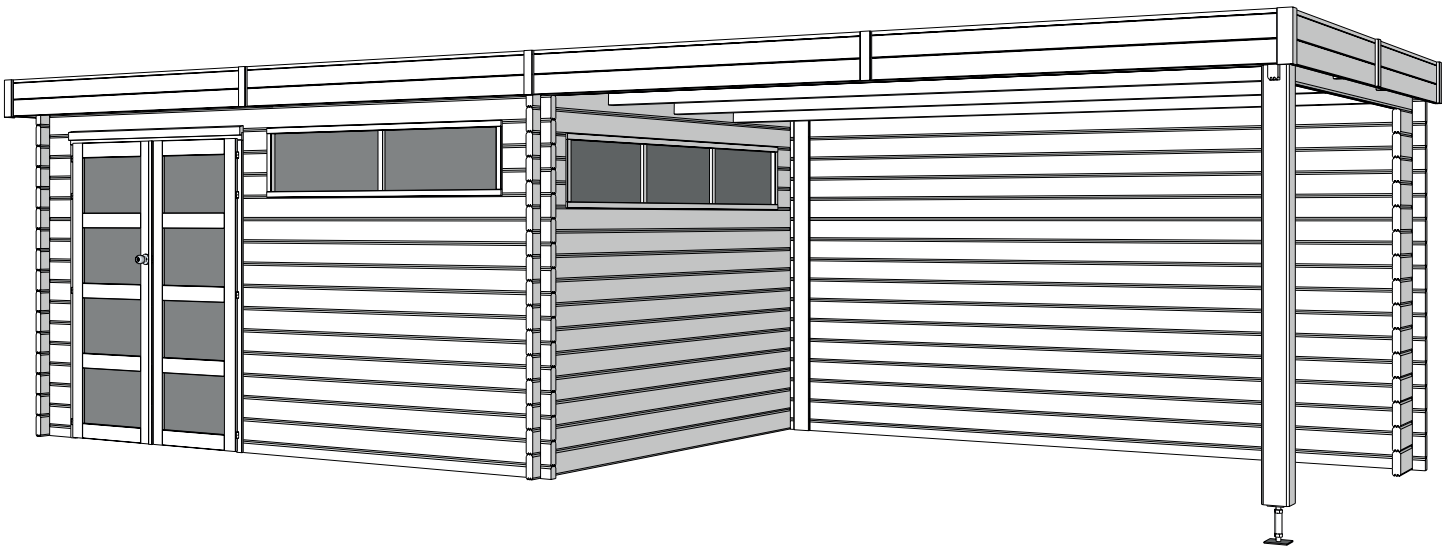

WOODLANDS

QUALITY CABINS



GEDETAILEERDE ONDERDELENLIJST

-

LISTE D'INVENTAIRE DETAILLEE

Download uw montage instructies op www.gardenas.be

Téléchargez vos instructions de montage sur www.gardenas.be

Onderdelenlijst Liste d'inventaire

Typ **44mm 415x295 cm PDDDM04**

4603AC/ISO

Artikel nr / Nr Article Afmeting / Dimension # Functie / Fonction
A B C

Wandelementen / Éléments des parois

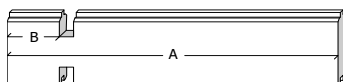

Z1/2313/0070	2313	70	(-)	<u>11</u>	onder raam voorgevel / sous fenêtre façade
Z1/0345/0070	345	70	(-)	<u>17</u>	naast deur en raam voorgevel / côté porte et fenêtre façade
Z1/0315/0070	315	70	(-)	<u>6</u>	naast raam zijgevel / côté fenêtre paroi latérale

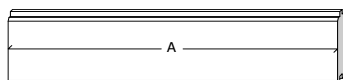

Z2/0233	233	(-)	(-)	<u>3</u>	tussen raam & deur voorgevel / entre fenêtre & porte façade
---------	-----	-----	-----	----------	---

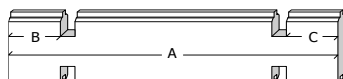

Z3/4150/0070/0070	4150	70	70	<u>16</u>	achter- & voorgevel / façade et paroi arrière
Z3/2950/0070/0070	2950	70	70	<u>27</u>	zijgevel / paroi latérale

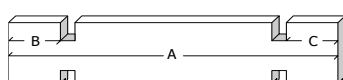

Z5/4150/0070/0070	4150	70	70	<u>1</u>	bovenste plank voorgevel / planche supérieure façade
-------------------	------	----	----	----------	--

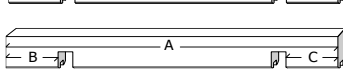

Z0/4150/QQ001	4150	70	70	<u>1</u>	bovenste plank achtergevel / planche supérieure paroi arrière
---------------	------	----	----	----------	---

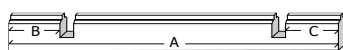

Z7/4150/0070/0070	4150	70	70	<u>2</u>	basis voor- & achtergevel / base paroi avant et arrière
-------------------	------	----	----	----------	---

Dakelementen / Éléments du toit



ZK/P2/3075/3/2/R	3075	195	70	<u>1</u>	helling rechts / pente droite
------------------	------	-----	----	----------	-------------------------------

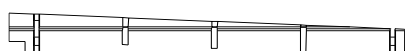

ZK/P2/3075/3/2/L	3075	195	70	<u>1</u>	helling links / pente gauche
------------------	------	-----	----	----------	------------------------------

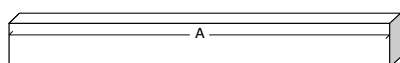

HDB/SET10				<u>1</u>	zak balkjes + sierlatjes / sachet poutres + lattes de finitions
P2/3980	3980	145	44	<u>3</u>	dakbalk / poutre du toit

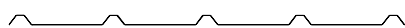

PPD1AC/3175/1000	3175	1000	(-)	<u>4</u>	profielplaten / panneaux profilés
------------------	------	------	-----	----------	-----------------------------------



PPD1AC/3175/0150	3175	150	(-)	<u>1</u>	profielplaten / panneaux profilés
------------------	------	-----	-----	----------	-----------------------------------

Afwerkingselementen / Éléments de finition

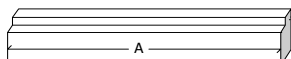

SRD/1522	1522	(-)	(-)	<u>2</u>	sierlat boven deurkader / latte de finition cadre de porte
----------	------	-----	-----	----------	--

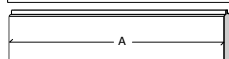

FSLMA/2090/115	2090	115	(-)	<u>2</u>	frontale sierlat tand / latte de finition frontale languette
FSLMB/2090/108	2090	108	(-)	<u>2</u>	frontale sierlat groef / latte de finition frontale rainure

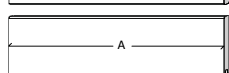

FSLMA/3230/115	3230	115	(-)	<u>2</u>	ziersierlat tand / latte de finition latérale languette
FSLMB/3230/108	3230	108	(-)	<u>2</u>	ziersierlat groef / latte de finition latérale rainure



SSL45/4200	4200	(-)	(-)	<u>1</u>	stormsierlat op het dak (voorkant) / latte de finition sur le toit (façade)
SSL45/3300	3300	(-)	(-)	<u>2</u>	stormsierlat op het dak (zijkant) / latte de finition sur le toit (latérale)
M/1920	1920	(-)	(-)	<u>1</u>	makelaar deur / latte de cache porte

DDM04-S/PLXM				<u>1</u>	opdekdeur modern voor slot / porte modern à recouvrement serrure
DDM04-V/PLXM				<u>1</u>	opdekdeur modern vast / porte modern à recouvrement fixe
X/DDO	(3 delen / 3 pièces)			<u>1</u>	kader 44mm voor dubbele opdekdeur / cadre 44mm pour porte double à recouvrement

X/VRM2L/PLXM				<u>1</u>	vast raam 2 delig / fenêtre fixe 2 parties
--------------	--	--	--	----------	--

X/VRM3K/PLXM				<u>1</u>	vast raam 3 delig / fenêtre fixe 3 parties
--------------	--	--	--	----------	--

B/4603AC				<u>1</u>	zak beslag / sachet quincailerie
----------	--	--	--	----------	----------------------------------

Onderdelenlijst Liste d'inventaire

Typ 44mm 400x295 cm EXTPD

4600AB4030

Artikel nr / Nr Article Afmeting / Dimension # Functie / Fonction
A B C

Wandelementen / Éléments des parois

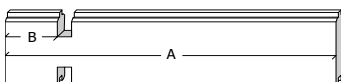

Z1/0425/0070 425 70 (-) 15 zijgevel extensie / paroi latéral extension
Z1/3955/0070 3955 70 (-) 15 achtergevel extensie / paroi arrière extension

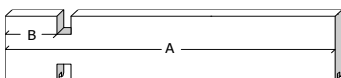

Z5/4070/0070 4070 70 (-) 1 bovenste plank voorgevel extensie / planche supérieure façade extension

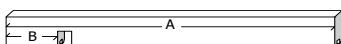

Z0/4070/0070 4070 70 (-) 1 bovenste plank achtergevel ext / planche supérieure paroi arrière ext

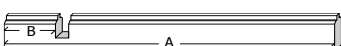

Z7/3955/0070 3955 70 (-) 1 basis achtergevel extensie / base paroi arrière extension

Dakelementen / Éléments du toit



ZK/P2/3075 3075 195 70 1 helling / pente

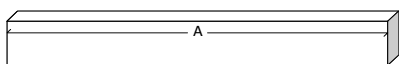

599937 1909 (-) (-) 1 paal / poteau
HDB/SET9 1 zak balkjes + sierlatjes / sachet poutres + lattes de finitions
P2/3956 3956 145 44 3 dakbalk / poutre du toit



300035 290 120 120 1 U-anker / U-socle



PPD1AC/3175/1000 3175 1000 (-) 4 profielplaten / panneaux profilés

Afwerkingselementen / Éléments de finition

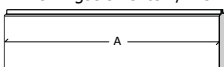

FSLMA/4080/115 4080 115 (-) 1 frontale sierlat tand / latte de finition frontale languette
FSLMB/4080/108 4080 108 (-) 1 frontale sierlat groef / latte de finition frontale rainure

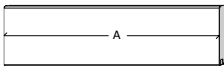

te zagen op lengte 4000 mm / à scier sur longueur 4000 mm

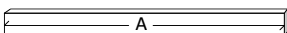

S/045/045/2010 2010 45 45 1 balkje verbinding achterwand / poutrelle connection par. arrière
SSL45/4200 4200 (-) (-) 1 stormsierlat op het dak (voorkant) / latte de finition sur le toit (façade)

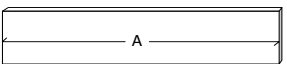

FSL/2100 2100 (-) (-) 1 sierlat verbinding achterwand / latte de finition connection par. arrière

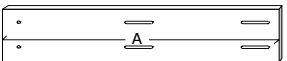

599906 2100 (-) (-) 1 sierlat verbinding achterwand / latte de finition connection par. arrière

B/4600AB 1 zak beslag / sachet quincaillerie



44MM 415X295 CM (ART 4603AC/ISO)

VOORZIJDDE - FACADE

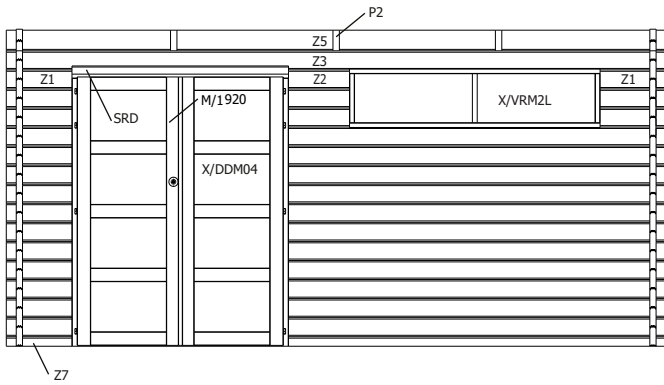

RUGZIJDDE - PAROI ARRIERE

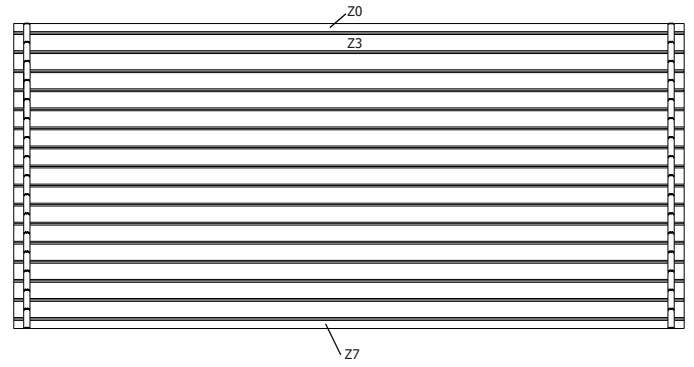

ZIJWAND - PAROI LATERALE

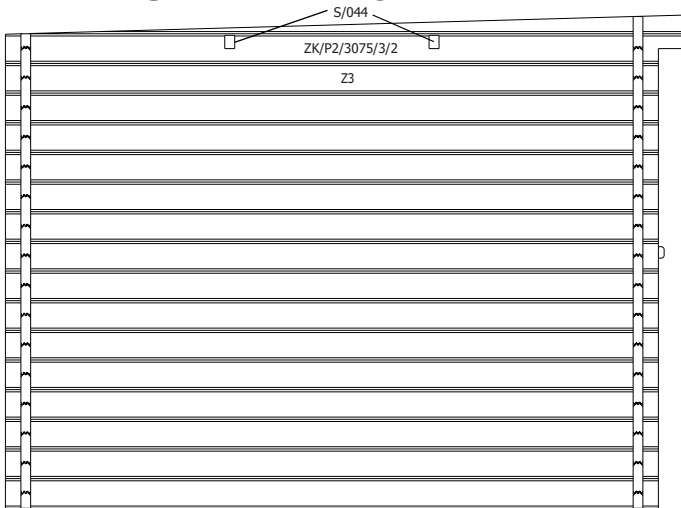

ZIJWAND - PAROI LATERALE

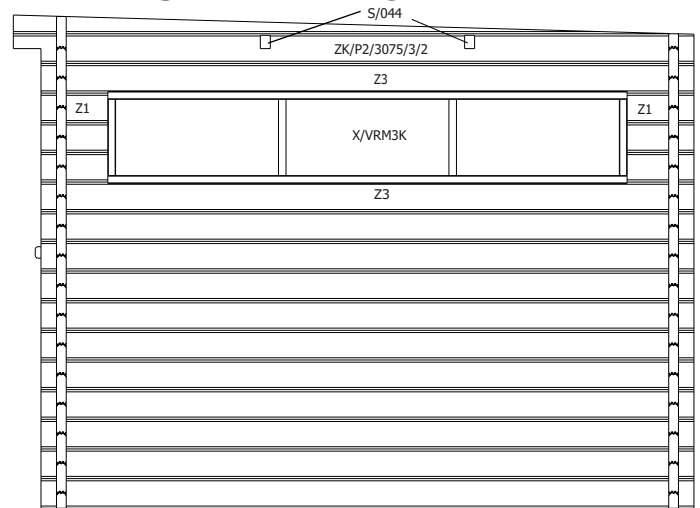

DAK - TOITURE

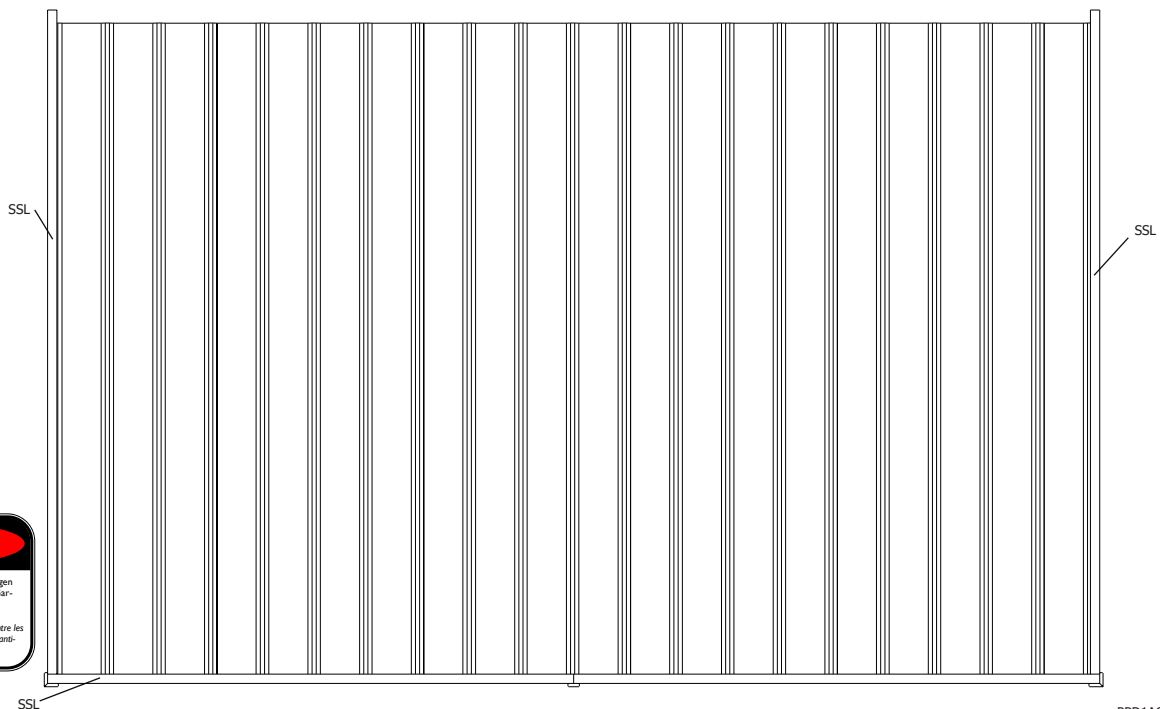

plaatsing van de staalplaten (vooraanzicht)

pose du toit en tôle (vue de face)

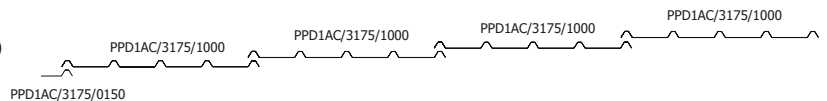

44MM 400X295 CM EXTPD (ART 4600AB4030AC/ISO)

ZIJAANZICHT - VUE LATERALE

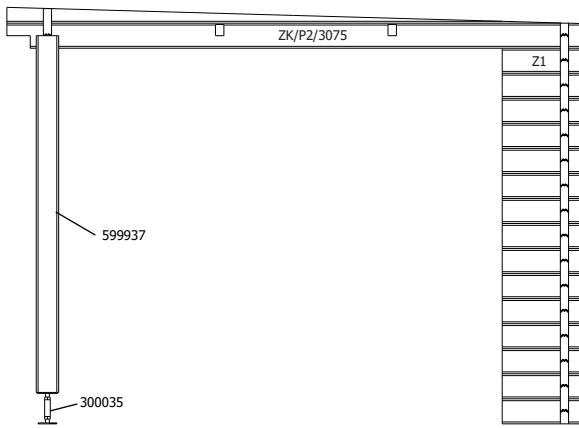

VOORZIJDJE - FACADE

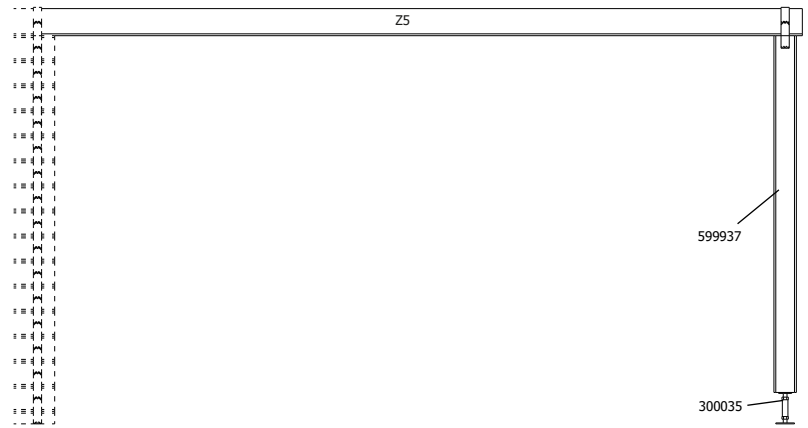

ACHTERZIJDJE - VUE ARRIERE

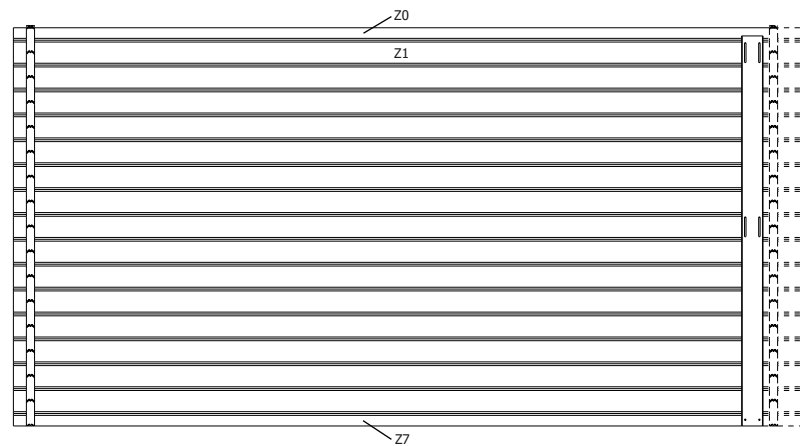

DAK - TOITURE

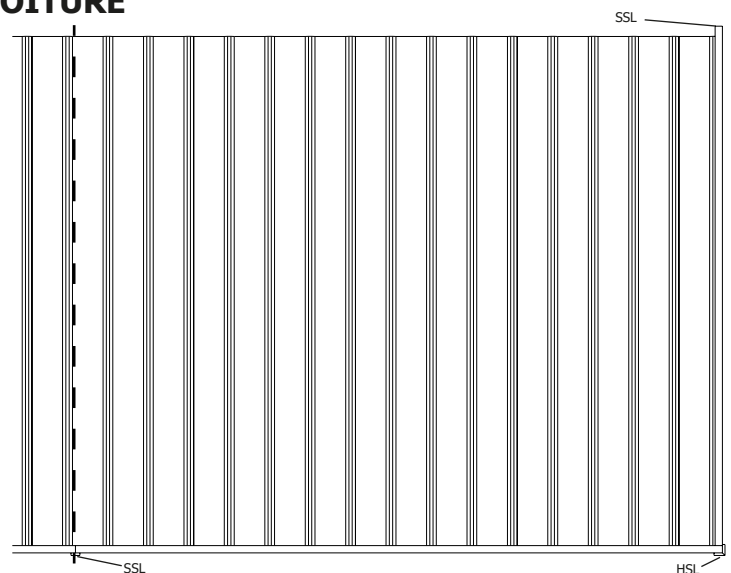
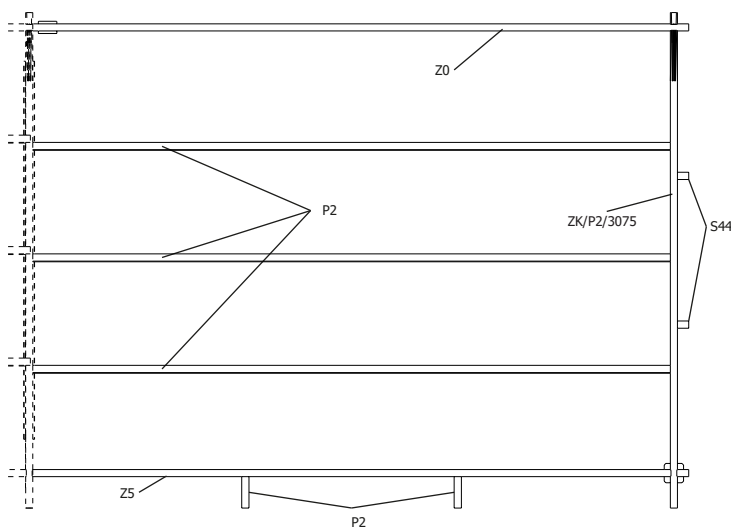

plaatsing van de staalplaten (vooraanzicht) - pose du toit en tôle (vue de face)

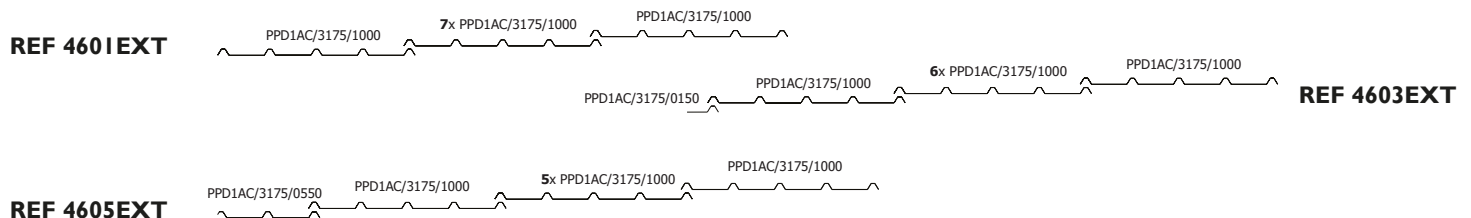

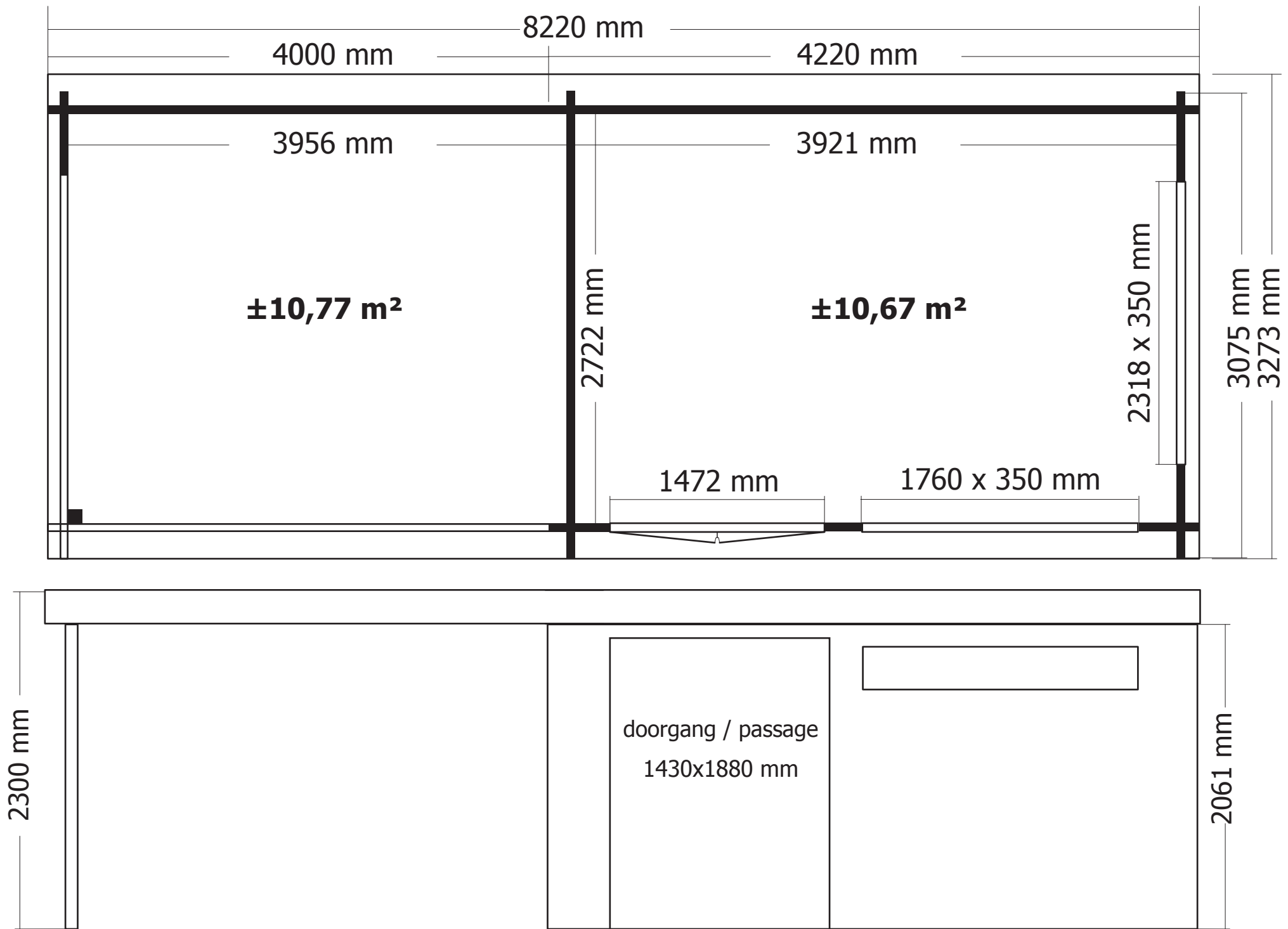

B/4603AC

aantal / nombre

Slot - Serrure (knoblock 28-45mm)
(Ref = 333005)

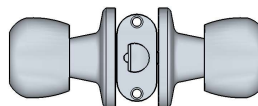

1

Scharnier paumelle groot - Charnière paumelle grand
(Ref = 300014)

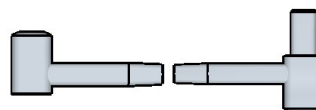

8 set

Kantschuif - Pêne (120mm)
(Ref = 300019)



2

Hoekijzer groot - Equerre grand (60x60x40)
(Ref = 300024)

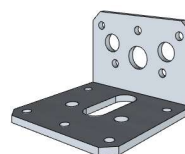

2

Schroeven - Vis

25mm
(Ref = 310018)



33

35mm
(Ref = 310007)

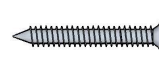

26

50mm
(Ref = 310013)



26

70mm
(Ref = 310009)



20

100mm
(Ref = 310005)



10

Schroef + kapje - Vis + capuchon (100mm)
(Ref = 310005 & 399007)

81



B/4600AB

Rondel - Rondelle (M8)
(Ref = 330001)

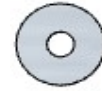

aantal / nombre

10

Houtdraadbout - Boulon (8x40)
(Ref = 340002)



10

Schroeven - Vis

25mm
(Ref = 310018)

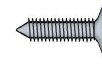

10

35mm
(Ref = 310007)



20

50mm
(Ref = 310013)



16

70mm
(Ref = 310009)



8

100mm
(Ref = 310005)



28

Schroef + kapje - Vis + capuchon (100mm)
(Ref = 310005 & 399007)

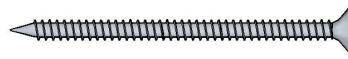

65

HDB/SET10

Voor artikel / Pour article:

4601

4603

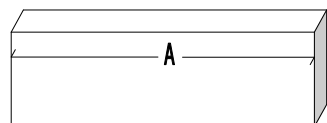

ARTIKEL NR

NR ARTICLE

P2/0195

S/044/060/0070

AANTAL

NOMBRE

3

4

FUNCTIE

FONCTION

hulpdakbalk / poutre de toit d'aide

hulpdakbalk / poutre de toit d'aide



SSL/0230

HSL/0230

7

4

sierlat / latte de finition

sierlat hoek / latte de finition coin

HDB/SET9

Voor artikel / Pour article:

4600AB4030

4600AB4040

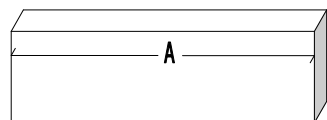

<u>ARTIKEL NR</u>	<u>AANTAL</u>	<u>FUNCTIE</u>
<u>NR ARTICLE</u>	<u>NOMBRE</u>	<u>FONCTION</u>
P2/0195	2	hulpdakbalk / poutre de toit d'aide

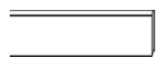

SSL/0230	2	sierlat / latte de finition
----------	---	-----------------------------