

44MM 355+400X295 CM (ART 4605EXT400AC/ISO)

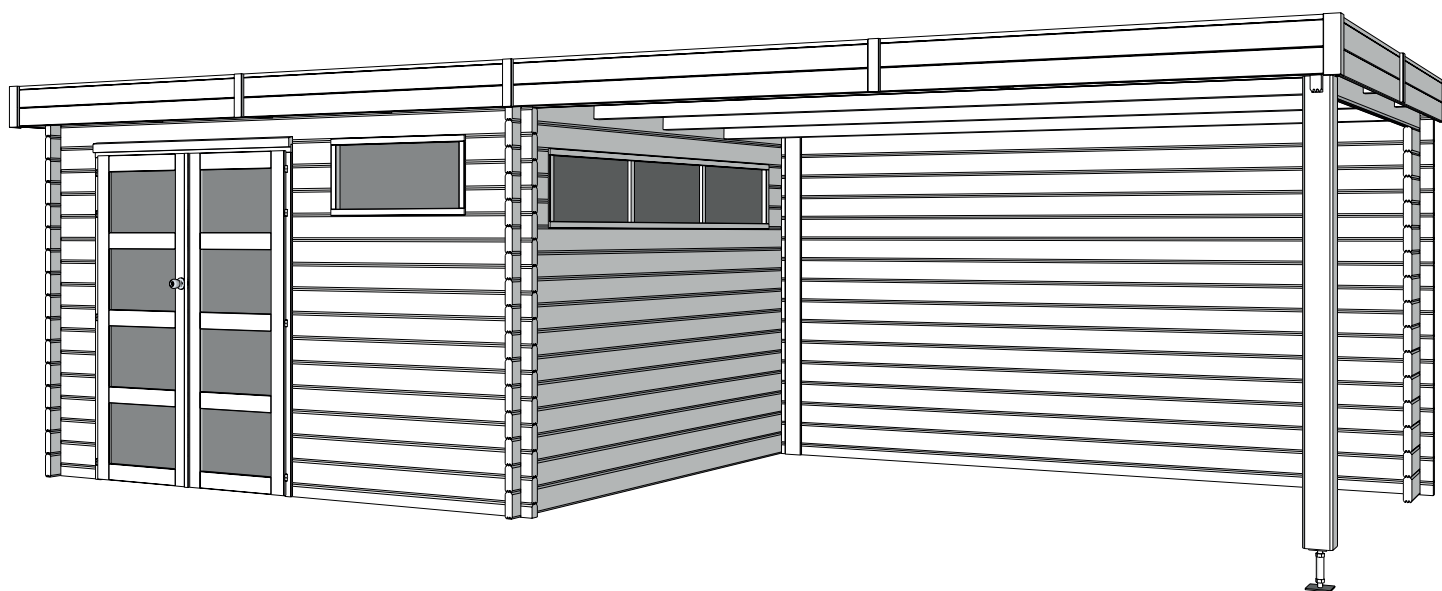

WOODLANDS

QUALITY CABINS



GEDETAILLEERDE ONDERDELENLIJST

-

LISTE D'INVENTAIRE DETAILLEE

Download uw montage instructies op www.gardenas.be

Téléchargez vos instructions de montage sur www.gardenas.be

Onderdelenlijst Liste d'inventaire

Typ **44mm 355x295 cm PDDDM04**

4605AC/ISO

Artikel nr / Nr Article Afmeting / Dimension # Functie / Fonction

Wandelementen / Éléments des parois					
	Z1/1623/0070	1623	70	(-) 11	onder raam voorgevel / sous fenêtre façade
	Z1/0435/0070	435	70	(-) 17	naast deur en raam voorgevel / côté porte et fenêtre façade
	Z1/0315/0070	315	70	(-) 6	naast raam zijgevel / côté fenêtre paroi latérale
	Z2/0313	313	(-)	(-) 3	tussen raam & deur voorgevel / entre fenêtre & porte façade
	Z3/3550/0070/0070	3550	70	70 16	achter- & voorgevel / façade et paroi arrière
	Z3/2950/0070/0070	2950	70	70 27	zijgevel / paroi latérale
	Z5/3550/0070/0070	3550	70	70 1	bovenste plank voorgevel / planche supérieure façade
	Z0/3550/QQ001	3550	70	70 1	bovenste plank achtergevel / planche supérieure paroi arrière
	Z7/3550/0070/0070	3550	70	70 2	basis voor- & achtergevel / base paroi avant et arrière

Dakelementen / Éléments du toit					
	ZK/P2/3075/3/4/R	3075	195	70 1	helling rechts / pente droite
	ZK/P2/3075/3/4/L	3075	195	70 1	helling links / pente gauche
	HDB/SET12			1	zak balkjes + sierlatjes / sachet poutres + lattes de finitions
	P4/3380	3380	120	44 3	dakbalk / poutre du toit
	PPD1AC/3175/1000	3175	1000	(-) 3	profielplaten / panneaux profilés
	PDD1AC/3175/0550	3175	550	(-) 1	profielplaten / panneaux profilés

Afwerkingselementen / Éléments de finition					
	SRD/1522	1522	(-)	(-) 2	sierlat boven deurkader / latte de finition cadre de porte
	FSLMA/3830/115	3830	115	(-) 1	frontale sierlat tand / latte de finition frontale languette
	FSLMB/3830/108	3830	108	(-) 1	frontale sierlat groef / latte de finition frontale rainure
	te zagen op lengte 3588 mm / à scier sur longueur 3588 mm				
	FSLMA/3230/115	3230	115	(-) 2	ziersierlat tand / latte de finition latérale languette
FSLMB/3230/108	3230	108	(-) 2	ziersierlat groef / latte de finition latérale rainure	
	SSL45/3600	3600	(-)	(-) 1	stormsierlat op het dak (voorkant) / latte de finition sur le toit (façade)
	SSL45/3300	3300	(-)	(-) 2	stormsierlat op het dak (zijkant) / latte de finition sur le toit (latérale)
	M/1920	1920	(-)	(-) 1	makelaar deur / latte de cache porte
	DDM04-S/PLXM			1	opdeur modern voor slot / porte modern à recouvrement serrure
	DDM04-V/PLXM			1	opdeur modern vast / porte modern à recouvrement fixe
	X/DDO	(3 delen / 3 pièces)		1	kader 44mm voor dubbele opdeur / cadre 44mm pour porte double à recouvrement
	X/VRM1L/PLXM			1	vast raam 1 delig / fenêtre fixe 1 parties
	X/VRM3K/PLXM			1	vast raam 3 delig / fenêtre fixe 3 parties
	B/4605AC			1	zak beslag / sachet quincaillerie

Onderdelenlijst Liste d'inventaire

Typ **44mm 400x295 cm EXTPD**

4600AB4030

Artikel nr / Nr Article Afmeting / Dimension # Functie / Fonction
A B C

Wandelementen / Éléments des parois

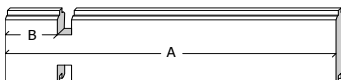

Z1/0425/0070	425	70	(-)	15	zijgevel extensie / paroi latéral extension
Z1/3955/0070	3955	70	(-)	15	achtergevel extensie / paroi arrière extension

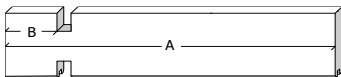

Z5/4070/0070	4070	70	(-)	1	bovenste plank voorgevel extensie / planche supérieure façade extension
--------------	------	----	-----	----------	---

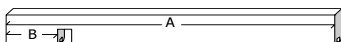

Z0/4070/0070	4070	70	(-)	1	bovenste plank achtergevel ext / planche supérieure paroi arrière ext
--------------	------	----	-----	----------	---

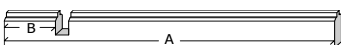

Z7/3955/0070	3955	70	(-)	1	basis achtergevel extensie / base paroi arrière extension
--------------	------	----	-----	----------	---

Dakelementen / Éléments du toit



ZK/P2/3075	3075	195	70	1	helling / pente
------------	------	-----	----	----------	-----------------

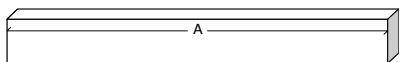

599937	1909	(-)	(-)	1	paal / poteau
HDB/SET9				1	zak balkjes + sierlatjes / sachet poutres + lattes de finitions
P2/3956	3956	145	44	3	dakbalk / poutre du toit



300035	290	120	120	1	U-anker / U-socle
--------	-----	-----	-----	----------	-------------------



PPD1AC/3175/1000	3175	1000	(-)	4	profielplaten / panneaux profilés
------------------	------	------	-----	----------	-----------------------------------

Afwerkingselementen / Éléments de finition

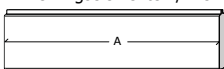

FSLMA/4080/115	4080	115	(-)	1	frontale sierlat tand / latte de finition frontale languette
FSLMB/4080/108	4080	108	(-)	1	frontale sierlat groef / latte de finition frontale rainure



te zagen op lengte 4000 mm / à scier sur longueur 4000 mm

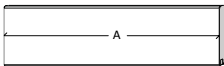

S/045/045/2010	2010	45	45	1	balkje verbinding achterwand / poutrelle connection par. arrière
SSL45/4200	4200	(-)	(-)	1	stormsierlat op het dak (voorkant) / latte de finition sur le toit (façade)

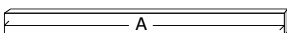

FSL/2100	2100	(-)	(-)	1	sierlat verbinding achterwand / latte de finition connection par. arrière
----------	------	-----	-----	----------	---

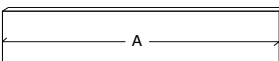

599906	2100	(-)	(-)	1	sierlat verbinding achterwand / latte de finition connection par. arrière
--------	------	-----	-----	----------	---

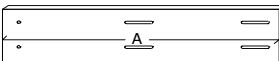

B/4600AB				1	zak beslag / sachet quincaillerie
----------	--	--	--	----------	-----------------------------------

44MM 415X295 CM (ART 4605AC/ISO)

VOORZIJDDE - FACADE

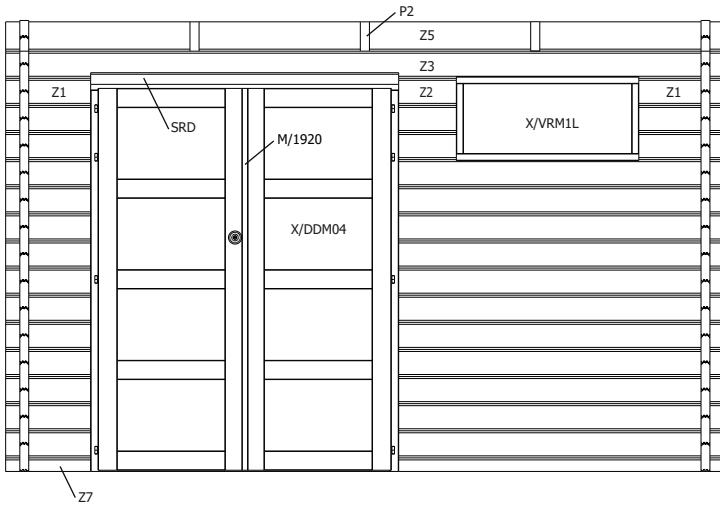

RUGZIJDDE - PAROI ARRIERE

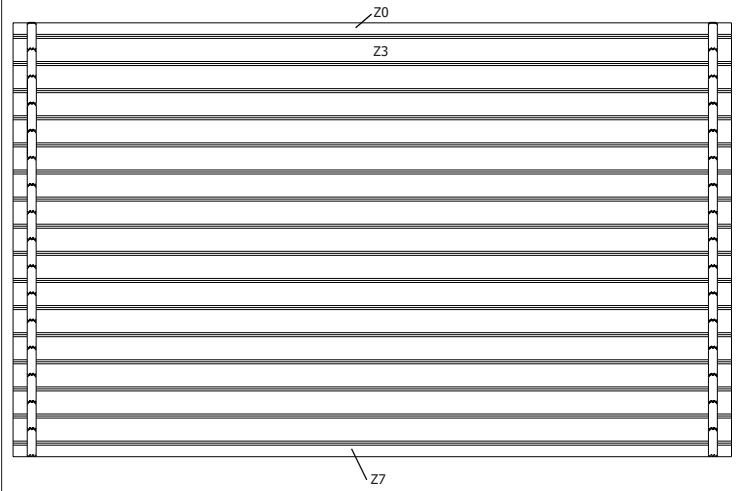

ZIJWAND - PAROI LATERALE

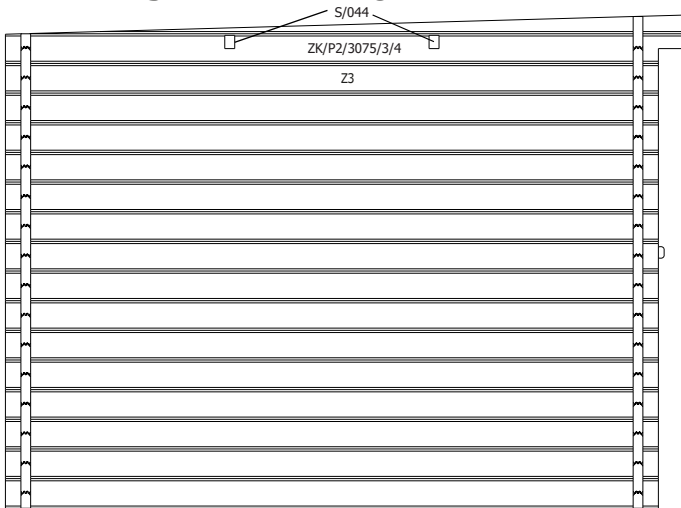

ZIJWAND - PAROI LATERALE

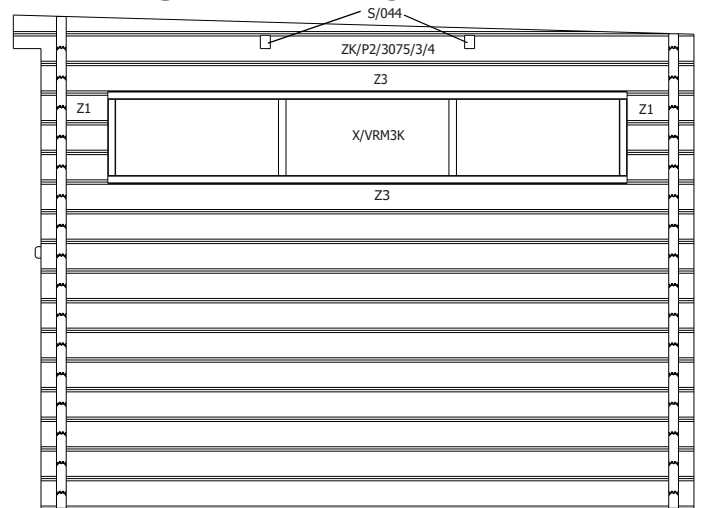

DAK - TOITURE

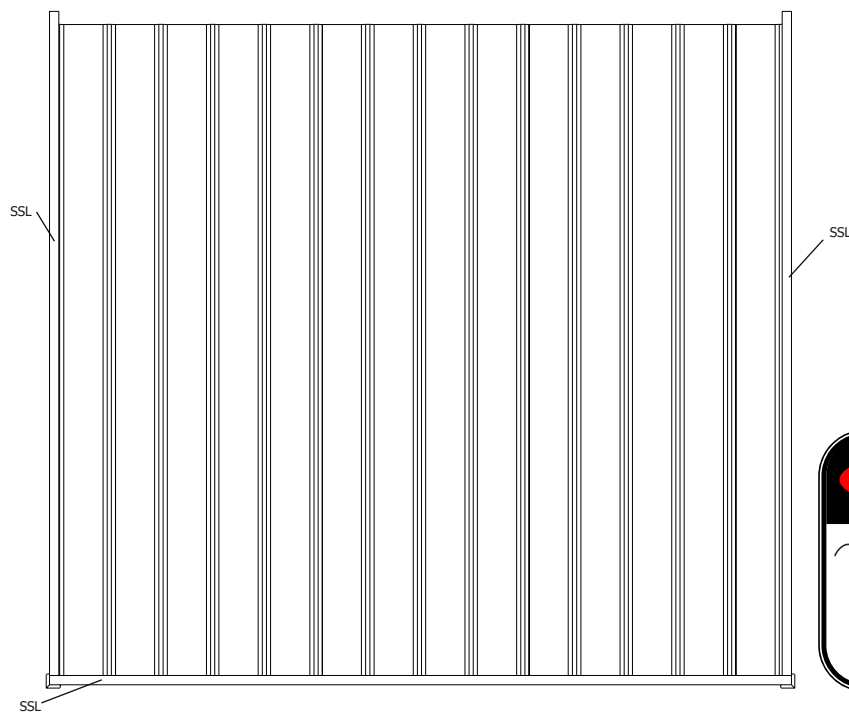

plaatsing van de staalplaten (vooraanzicht)

pose du toit en tôle (vue de face)

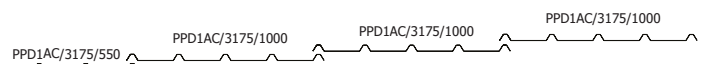

44MM 400X295 CM EXTPD (ART 4600AB4030AC/ISO)

ZIJAANZICHT - VUE LATERALE

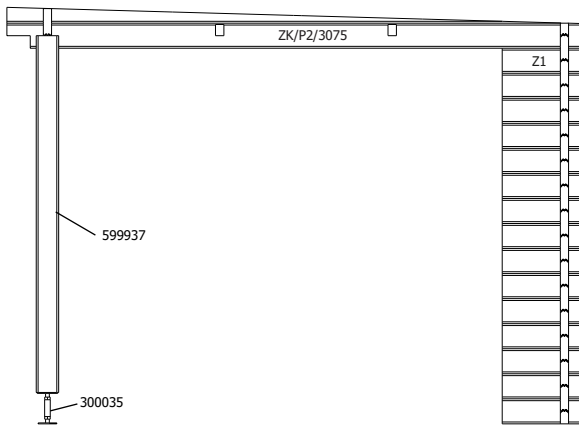

VOORZIJDJE - FACADE



ACHTERZIJDJE - VUE ARRIERE

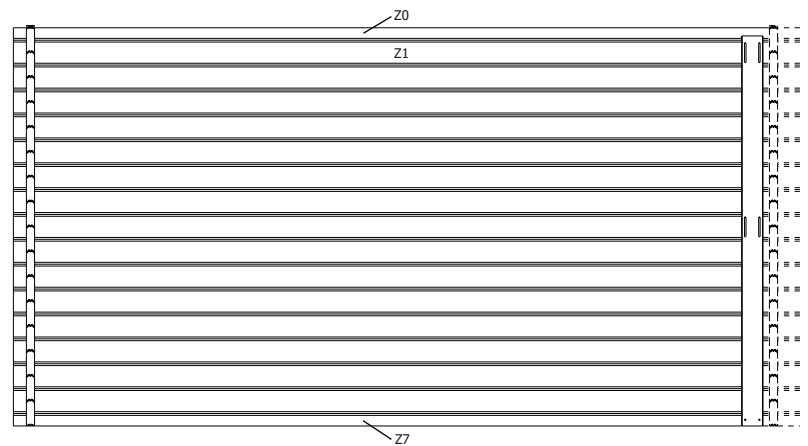

DAK - TOITURE

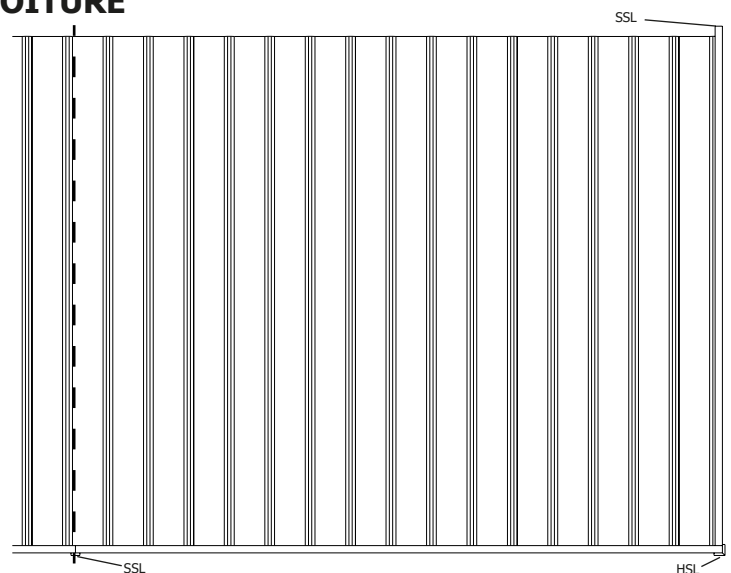
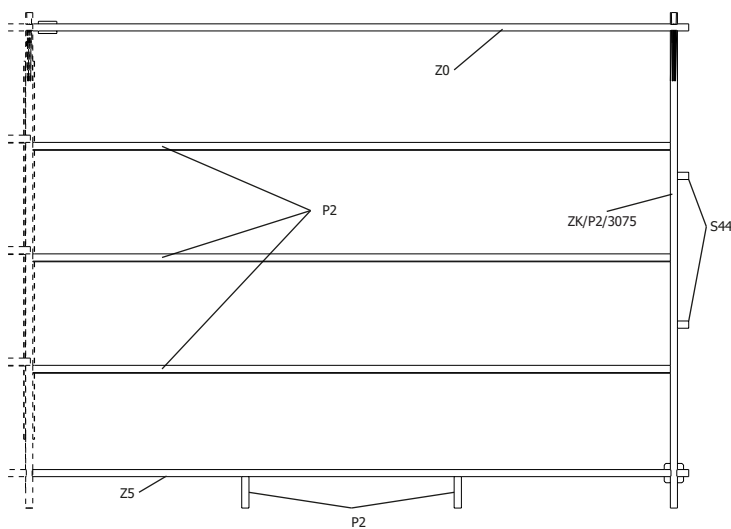

plaatsing van de staalplaten (vooraanzicht) - pose du toit en tôle (vue de face)

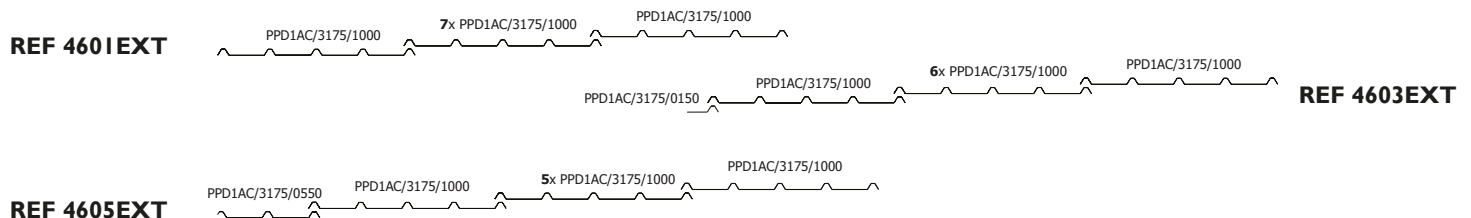

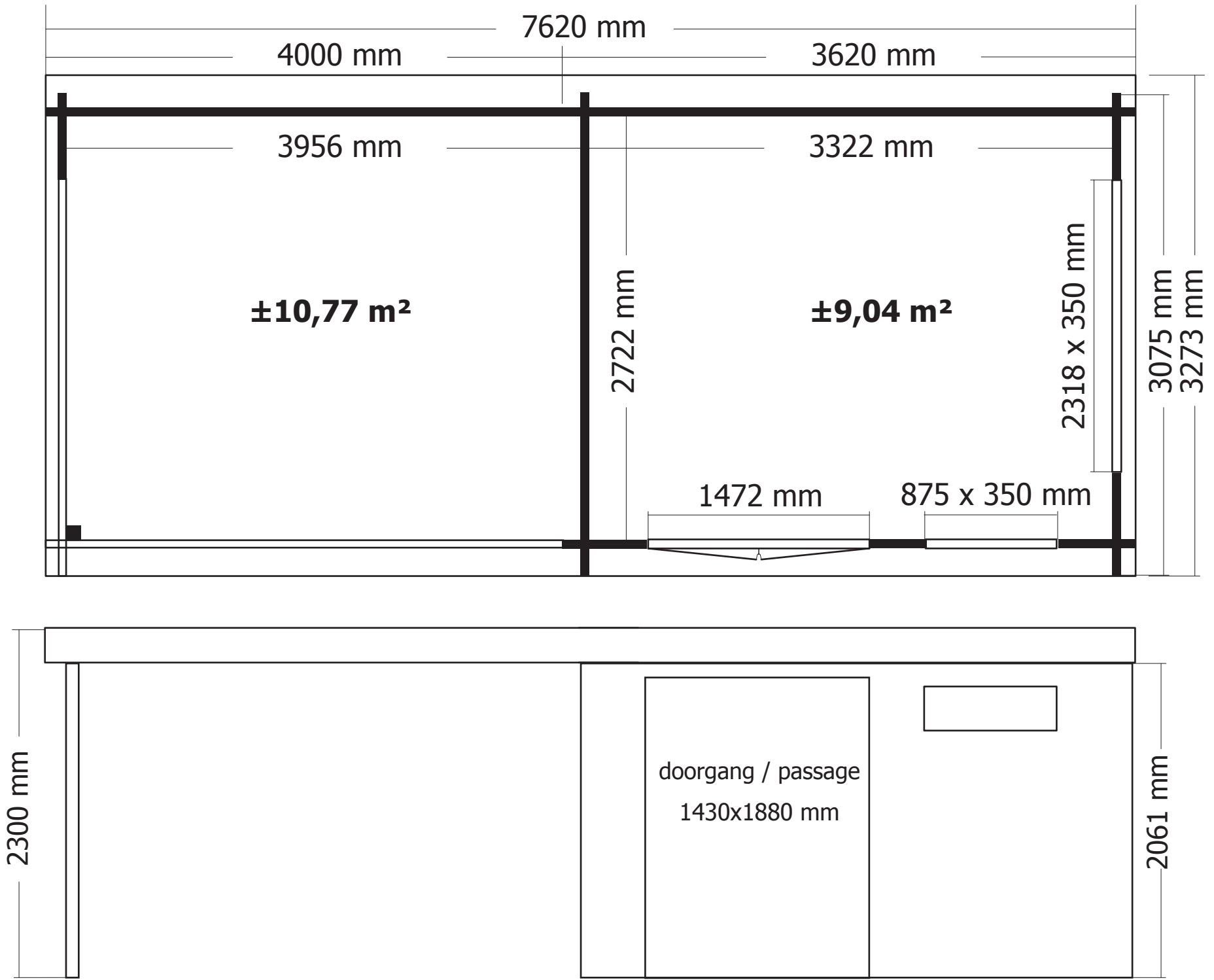

B/4605AC

aantal / nombre

Slot - Serrure (knoblock 28-45mm)
(Ref = 333005)

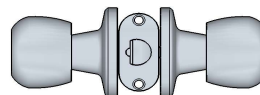

1

Scharnier paumelle groot - Charnière paumelle grand
(Ref = 300014)

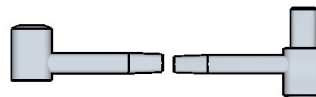

8 set

Kantschuif - Pêne (120mm)
(Ref = 300019)



2

Hoekijzer groot - Equerre grand (60x60x40)
(Ref = 300024)

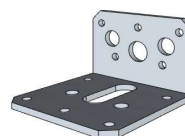

2

Schroeven - Vis

25mm
(Ref = 310018)



33

35mm
(Ref = 310007)



26

50mm
(Ref = 310013)



26

70mm
(Ref = 310009)



18

100mm
(Ref = 310005)



12

Schroef + kapje - Vis + capuchon (100mm)
(Ref = 310005 & 399007)

67



B/4600AB

Rondel - Rondelle (M8)
(Ref = 330001)

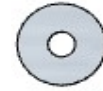

aantal / nombre

10

Houtdraadbout - Boulon (8x40)
(Ref = 340002)



10

Schroeven - Vis

25mm
(Ref = 310018)

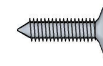

10

35mm
(Ref = 310007)



20

50mm
(Ref = 310013)



16

70mm
(Ref = 310009)



8

100mm
(Ref = 310005)

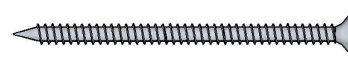

28

Schroef + kapje - Vis + capuchon (100mm)
(Ref = 310005 & 399007)

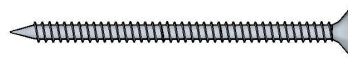

65

HDB/SET12

Voor artikel / Pour article:

4605

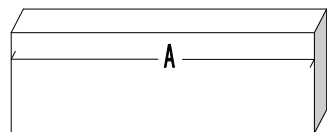

ARTIKEL NR
NR ARTICLE

P2/0195
S/044/060/0070

AANTAL
NOMBRE

3
4

FUNCTIE
FONCTION

hulpdakbalk / poutre de toit d'aide
hulpdakbalk / poutre de toit d'aide



SSL/0230
HSL/0230

5
4

sierlat / latte de finition
sierlat hoek / latte de finition coin

HDB/SET9

Voor artikel / Pour article:

4600AB4030

4600AB4040

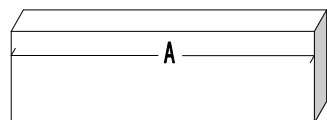

<u>ARTIKEL NR</u>	<u>AANTAL</u>	<u>FUNCTIE</u>
<u>NR ARTICLE</u>	<u>NOMBRE</u>	<u>FONCTION</u>
P2/0195	2	hulpdakbalk / poutre de toit d'aide

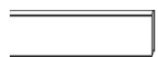

SSL/0230	2	sierlat / latte de finition
----------	---	-----------------------------