

**28MM 485X385+400 CM ALU PDDDM04 (ART 5105EXT400AC/ISO)**

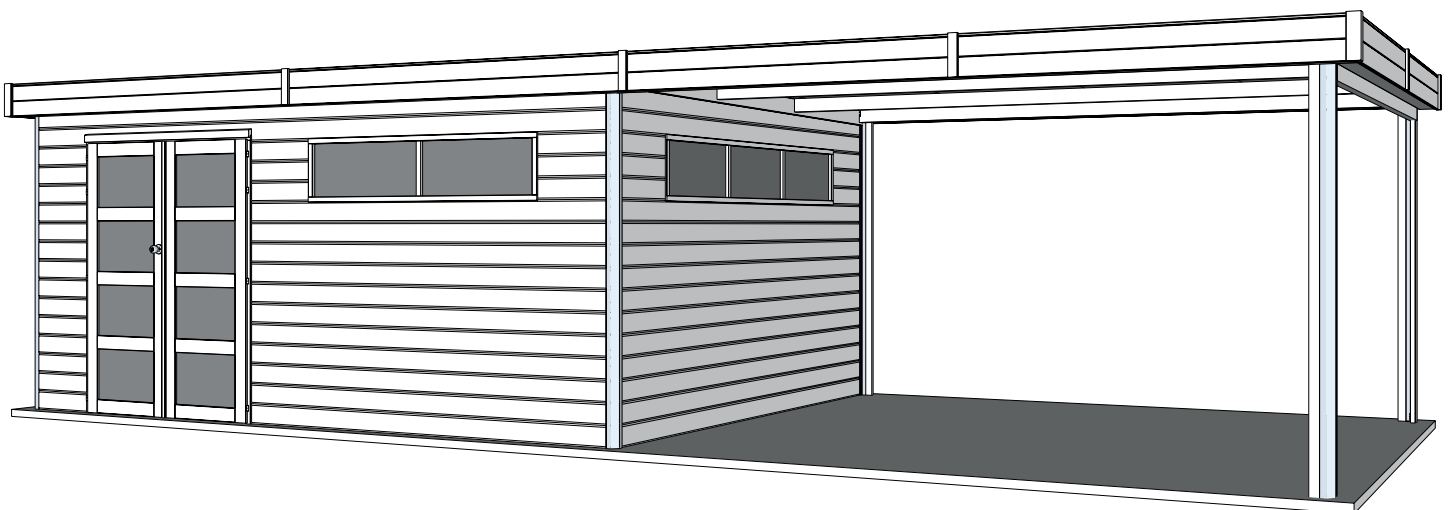

# **WOODLANDS**

**QUALITY CABINS**



**GEDETAILLEERDE ONDERDELENLIJST**  
-  
**LISTE D'INVENTAIRE DETAILLEE**

Download uw montage instructies op [www.gardenas.be](http://www.gardenas.be)

Téléchargez vos instructions de montage sur [www.gardenas.be](http://www.gardenas.be)

Onderdelenlijst  
Liste d'inventaire

Typ

**28 ALU 485x385 cm PDDDM04**

**5105AC/ISO**

Artikel nr / Dimension # Functie / Fonction  
Nr Article A B C

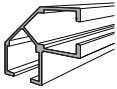

Wandelementen / Eléments des parois

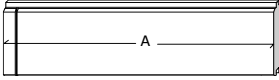
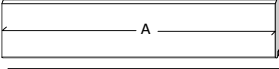
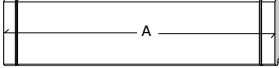
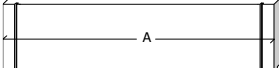
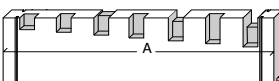
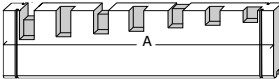
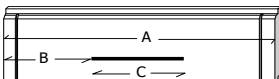

|   |                       |      |     |      |           |   |
|---|-----------------------|------|-----|------|-----------|---|
|   | ALU/28-34/L/2150      | 2150 | (-) | (-)  | <b>4</b>  | aluminium hoekprofiel / profile de coin aluminium<br>geanodiseerd / anodisé       |
|  | L1/0529               | 529  | (-) | (-)  | <b>17</b> | naast raam & deur voorgevel / côté fenêtre & porte façade                         |
|   | L1/0728               | 728  | (-) | (-)  | <b>6</b>  | naast raam zijgevel / côté fenêtre paroi latérale                                 |
|   | L1/2775               | 2775 | (-) | (-)  | <b>11</b> | onder raam voorgevel / sous fenêtre façade  |
|  | A2/0515               | 515  | (-) | (-)  | <b>3</b>  | tussen raam & deur voorgevel / entre fenêtre & porte façade                       |
|  | L3/3780               | 3780 | (-) | (-)  | <b>27</b> | plank zijgevel / planche paroi latérale   |
|   | L3/4780               | 4780 | (-) | (-)  | <b>15</b> | plank achtergevel / planche paroi arrière   |
|  | L5/4780               | 4780 | (-) | (-)  | <b>2</b>  | hoogste plank voor- en achterkant /<br>planche supérieure façade et paroi arrière |
|  | LK/P1/3780/7/2-L      | 3780 | (-) | (-)  | <b>1</b>  | hoogste plank linker zijkant / planche supérieure paroi latérale gauche           |
|  | LK/P1/3780/7/2-R      | 3780 | (-) | (-)  | <b>1</b>  | hoogste plank rechter zijkant / planche supérieure paroi latérale droite          |
|  | L6/4780/0529/1476/057 | 4780 | 529 | 1476 | <b>1</b>  | boven deur / au-dessus porte  |

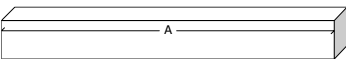
Dakelementen / Eléments du toit

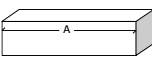

|   |                  |      |      |     |          |   |
|---|------------------|------|------|-----|----------|---|
|   | P2/4814          | 4814 | 145  | 44  | <b>7</b> | hoofddakbalk / poutre du toit principal                         |
|  | HDB/SET21        |      |      |     | <b>1</b> | zak balkjes + sierlatjes / sachet poutres + lattes de finitions |
|  | PPD1AC/4050/1000 | 4050 | 1000 | (-) | <b>5</b> | profielplaten / panneaux profilés                               |

Afwerkingselementen / Eléments de finition

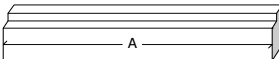

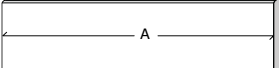
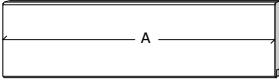
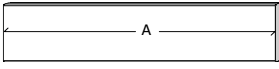
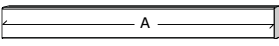
|   |                |                      |     |     |          |   |
|---|----------------|----------------------|-----|-----|----------|---|
|   | SRD/1502       | 1502                 | (-) | (-) | <b>2</b> | sierlat boven deurkader / latte de finition cadre de porte                      |
|  | FSLMA/2540/115 | 2540                 | 115 | (-) | <b>2</b> | frontale sierlat vooraan / latte de finition frontale avant                     |
|   | FSLMA/4080/115 | 4080                 | 115 | (-) | <b>2</b> | frontale sierlat zijwand / latte de finition frontale latérale                  |
|  | FSLMB/2540/108 | 2540                 | 108 | (-) | <b>2</b> | frontale sierlat vooraan / latte de finition frontale avant                     |
|   | FSLMB/4080/108 | 4080                 | 108 | (-) | <b>2</b> | frontale sierlat zijwand / latte de finition frontale latérale                  |
|  | OSL/4050       | 4050                 | 96  | (-) | <b>2</b> | overbouwsierlat zijkant / latte de finition d'auvent latérale                   |
|   | OSL/2682       | 2682                 | 96  | (-) | <b>2</b> | overbouwsierlat vooraan / latte de finition d'auvent avant                      |
|   | FSL/2700       | 2700                 | 118 | (-) | <b>2</b> | afwerkingslat achteraan / latte de finition arrière                             |
|  | SSL45/4200     | 4200                 | 45  | (-) | <b>2</b> | stormsierlat op het dak zijkant / latte de finition sur le toit latérale        |
|   | SSL45/2700     | 2700                 | 45  | (-) | <b>2</b> | stormsierlat op het dak vooraan / latte de finition sur le toit avant           |
|   | M/1920         | 1920                 | 30  | (-) | <b>1</b> | makelaar deur / latte de cache porte  |
|   | DDM04-S/PLXM   |                      |     |     | <b>1</b> | opdeur modern voor slot / porte modern à recouvrement serrure                   |
|   | DDM04-V/PLXM   |                      |     |     | <b>1</b> | opdeur modern vast / porte modern à recouvrement fixe                           |
|   | A/DDO          | (3 delen / 3 pièces) |     |     | <b>1</b> | kader 28mm voor dubbele opdeur /<br>cadre 28mm pour porte double à recouvrement |
|   | A/VRM2L/PLXM   |                      |     |     | <b>1</b> | vast raam 2 delig lang / fenêtre fixe 2 partie longue                           |
|   | A/VRM3K/PLXM   |                      |     |     | <b>1</b> | vast raam 3 delig kort / fenêtre fixe 3 parties courte                          |
|   | B/5105AC       |                      |     |     | <b>1</b> | zak beslag / sachet quincaillerie   |
|   | 321003         | 2080                 |     |     | <b>4</b> | draadstang / tige filée   |

Onderdelenlijst  
Liste d'inventaire

Typ

**28 ALU 400x385 PDEXT**

**5130AB4040**

Artikel nr / Dimension # Functie / Fonction  
Nr Article A B C

Wandelementen / Eléments des parois

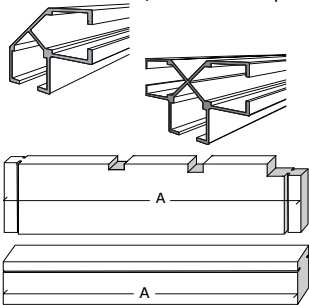

|                  |      |     |     |          |   |
|------------------|------|-----|-----|----------|---|
| ALU/28-34/L/2150 | 2150 | (-) | (-) | <b>1</b> | aluminium hoekprofiel / profile de coin aluminium<br>geanodiseerd / anodisé |
| ALU/28-34/T/2150 | 2150 | (-) | (-) | <b>1</b> | aluminium T-profiel / profile en T aluminium<br>geanodiseerd / anodisé      |
| P2R/3770/3/1     | 3770 | (-) | (-) | <b>1</b> | ligger extensie / poutre extension  |
| S28Z2/83/2020    | 2020 | 28  | 83  | <b>2</b> | opvulling aluprofiel / latte pour profil en aluminium                       |
| S28Z2/83/2150    | 2150 | 28  | 83  | <b>3</b> | opvulling aluprofiel / latte pour profil en aluminium                       |

Dakelementen / Eléments du toit

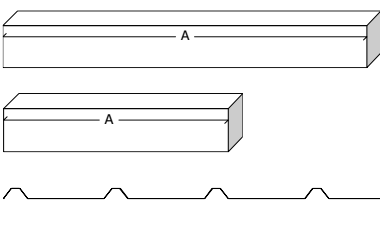

|                  |      |      |     |          |   |
|------------------|------|------|-----|----------|---|
| P1/4123          | 4123 | 95   | 44  | <b>4</b> | dakbalk extensie/ poutre extension                              |
| HDB/SET23        |      |      |     | <b>1</b> | zak balkjes + sierlatjes / sachet poutres + lattes de finitions |
| PPD1AC/4050/1000 | 4050 | 1000 | (-) | <b>4</b> | profielplaten / panneaux profilés                               |

Afwerkingselementen / Eléments de finition

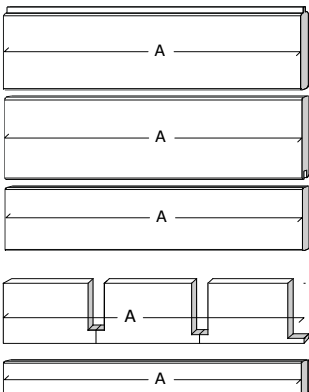

|                |      |     |     |          |  |
|----------------|------|-----|-----|----------|--|
| FSLMA/4080/115 | 4080 | 115 | (-) | <b>1</b> | frontale sierlat extensie / latte de finition frontale extension                         |
| FSLMB/4080/108 | 4080 | 108 | (-) | <b>1</b> | frontale sierlat extensie / latte de finition frontale extension                         |
| OSL/4050       | 4050 | 96  | (-) | <b>1</b> | overbouwsierlat extensie /<br>latte de finition d'auvent extension                       |
| FSL/4050       | 4050 | 118 | (-) | <b>2</b> | overbouwsierlat extensie /<br>latte de finition d'auvent extension                       |
| BSL/3669/3/1   | 3069 | 118 | (-) | <b>2</b> | binnensierlat extensie (3 stukken) /<br>latte de finition intérieur extension (3 pièces) |
| SSL45/4200     | 4200 | 45  | (-) | <b>1</b> | stormsierlat op het dak/ Latte de finition sur le toit                                   |
| B/5130AB4040   |      |     |     | <b>1</b> | zak beslag / sachet quincaillerie  |

# 28MM 485X385 CM ALU PDDDM04 (ART 5105AC/ISO)

## VOORZIJDDE - FACADE

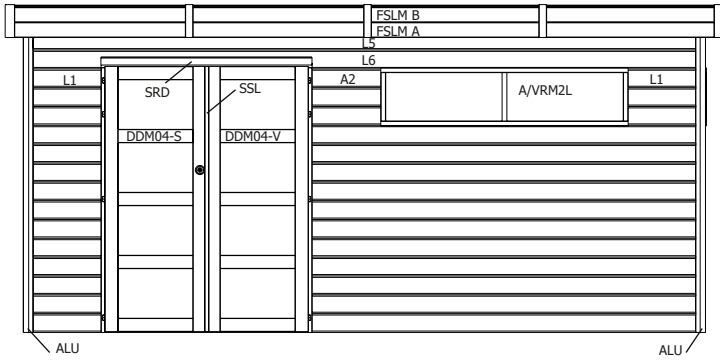

## RUGZIJDDE - PAROI ARRIERE

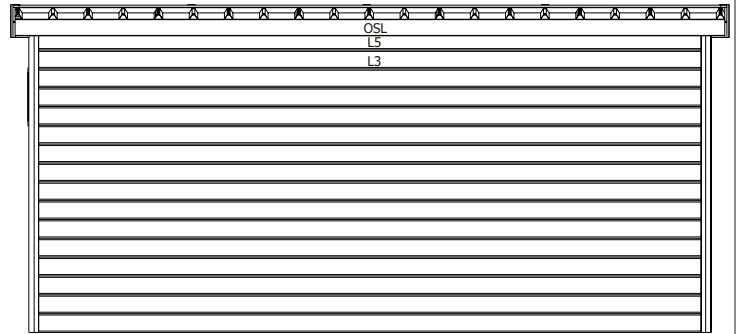

## ZIJWAND - PAROI LATERALE

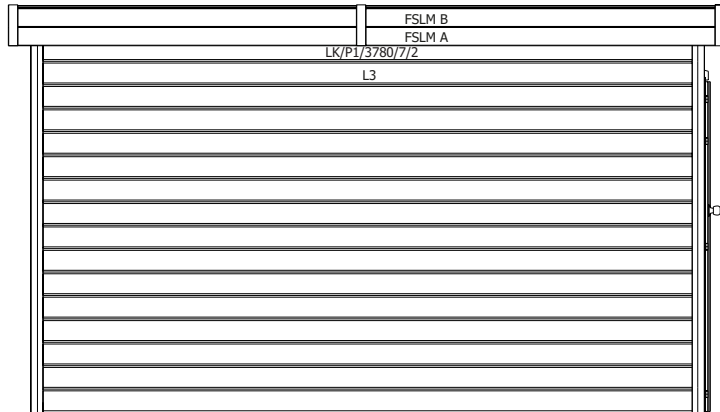

## ZIJWAND - PAROI LATERALE

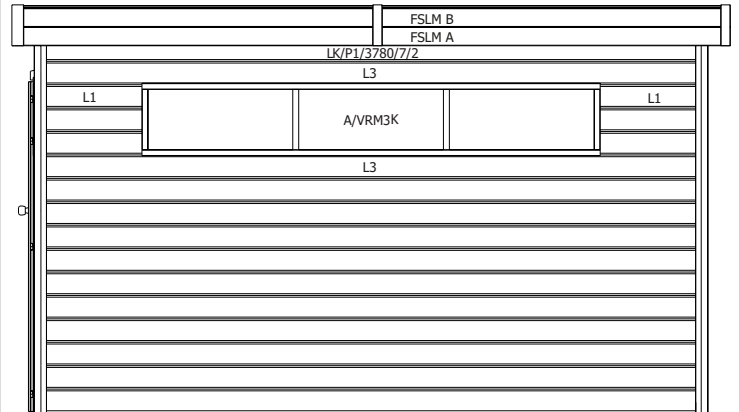

## DAK - TOITURE

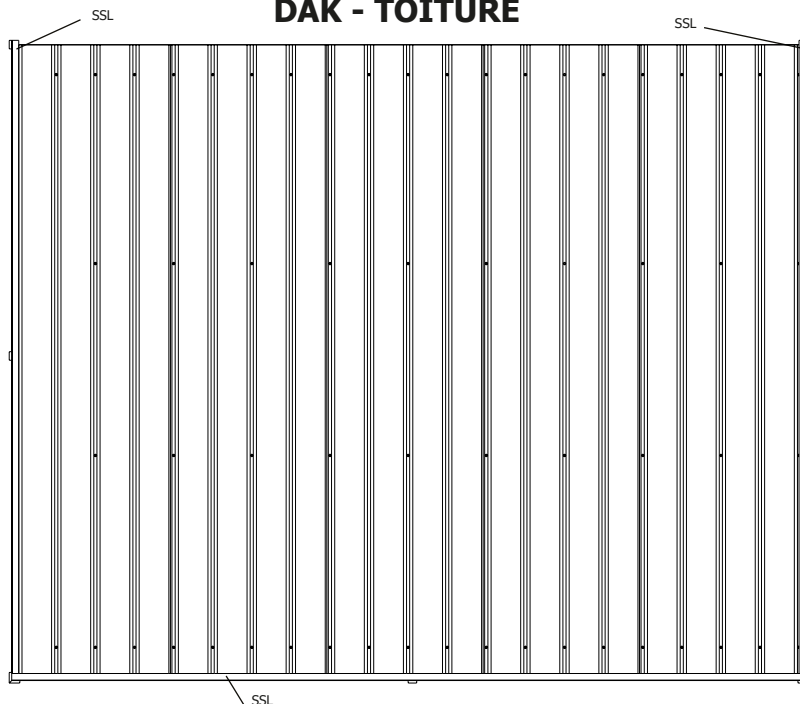

plaatsing van de staalplaten (vooraanzicht)

pose du toit en tôle (vue de face)

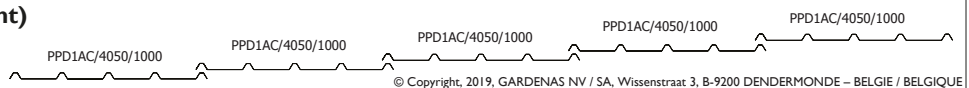

# 28MM 400X385 CM ALUAB (ART 5130AB4040AC/ISO)

## VOORZIJDJE - FACADE

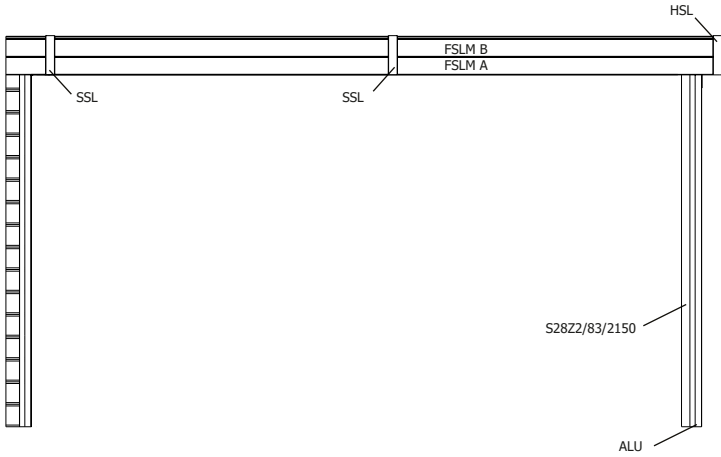

## RUGZIJDJE - PAROI ARRIERE

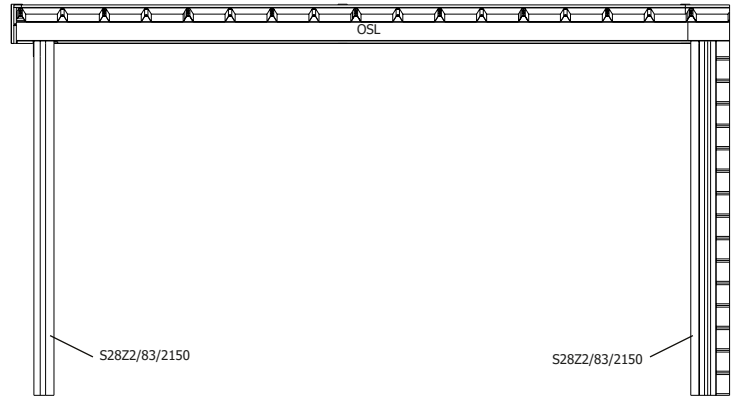

## ZIJWAND - PAROI LATERALE

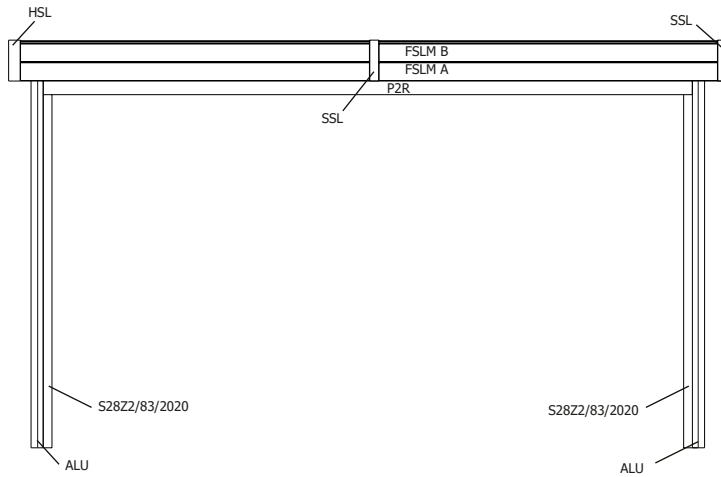

## DOORSNEDE BINNEN - COUPE INTERIEUR

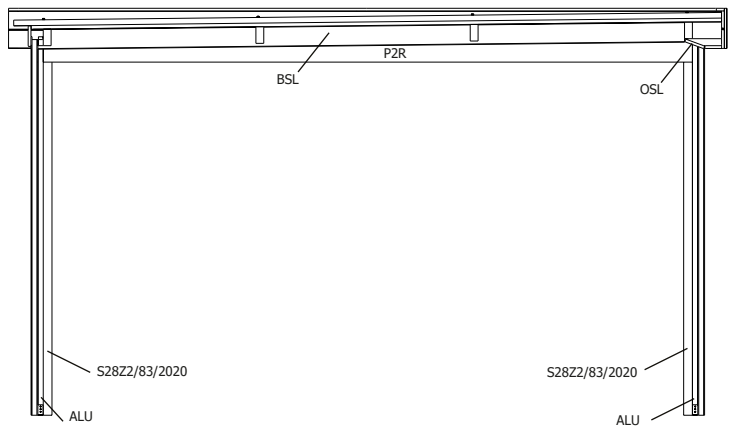

## DAK - TOITURE

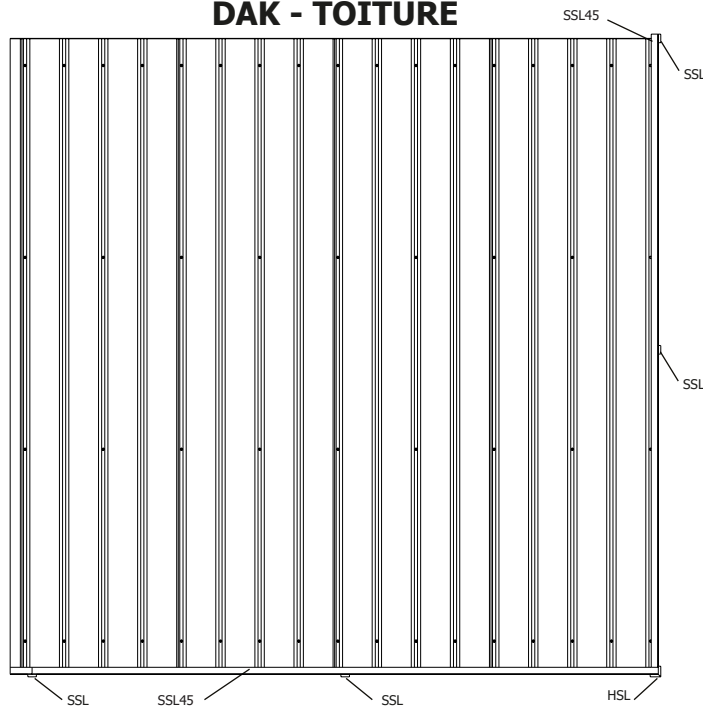

plaatsing van de staalplaten (vooraanzicht, excl tuinhuis) - pose du toit en tôle (vue de face, abris exclus)

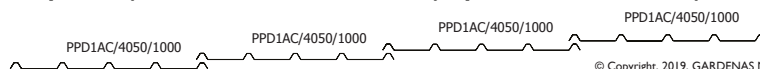

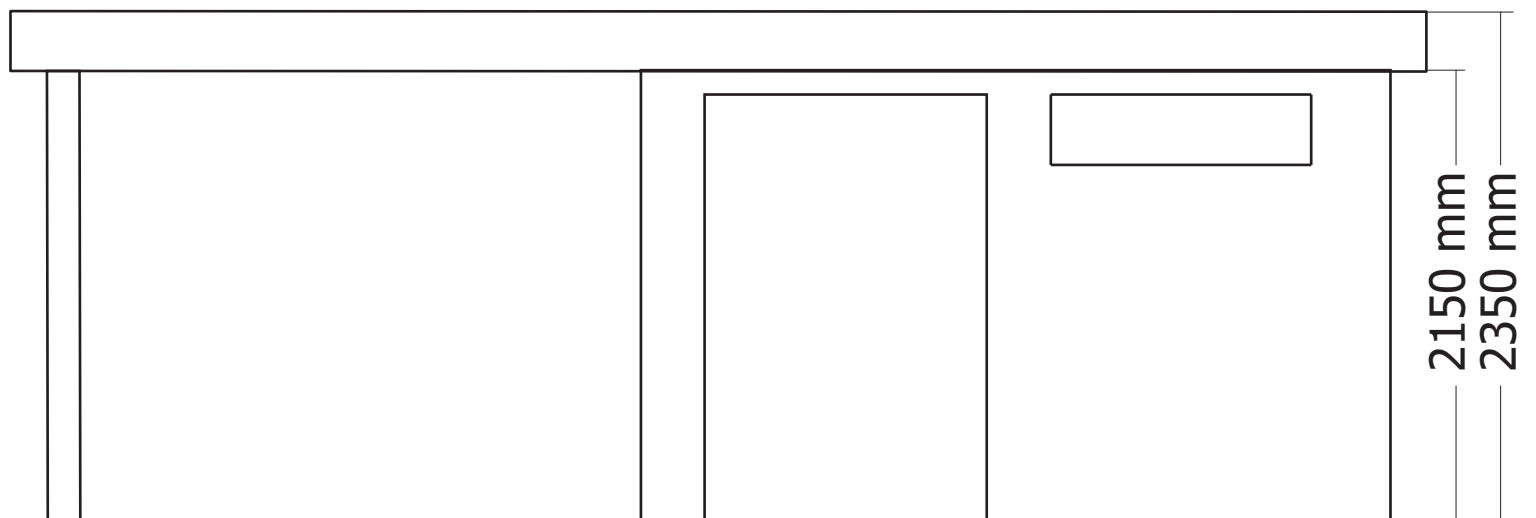
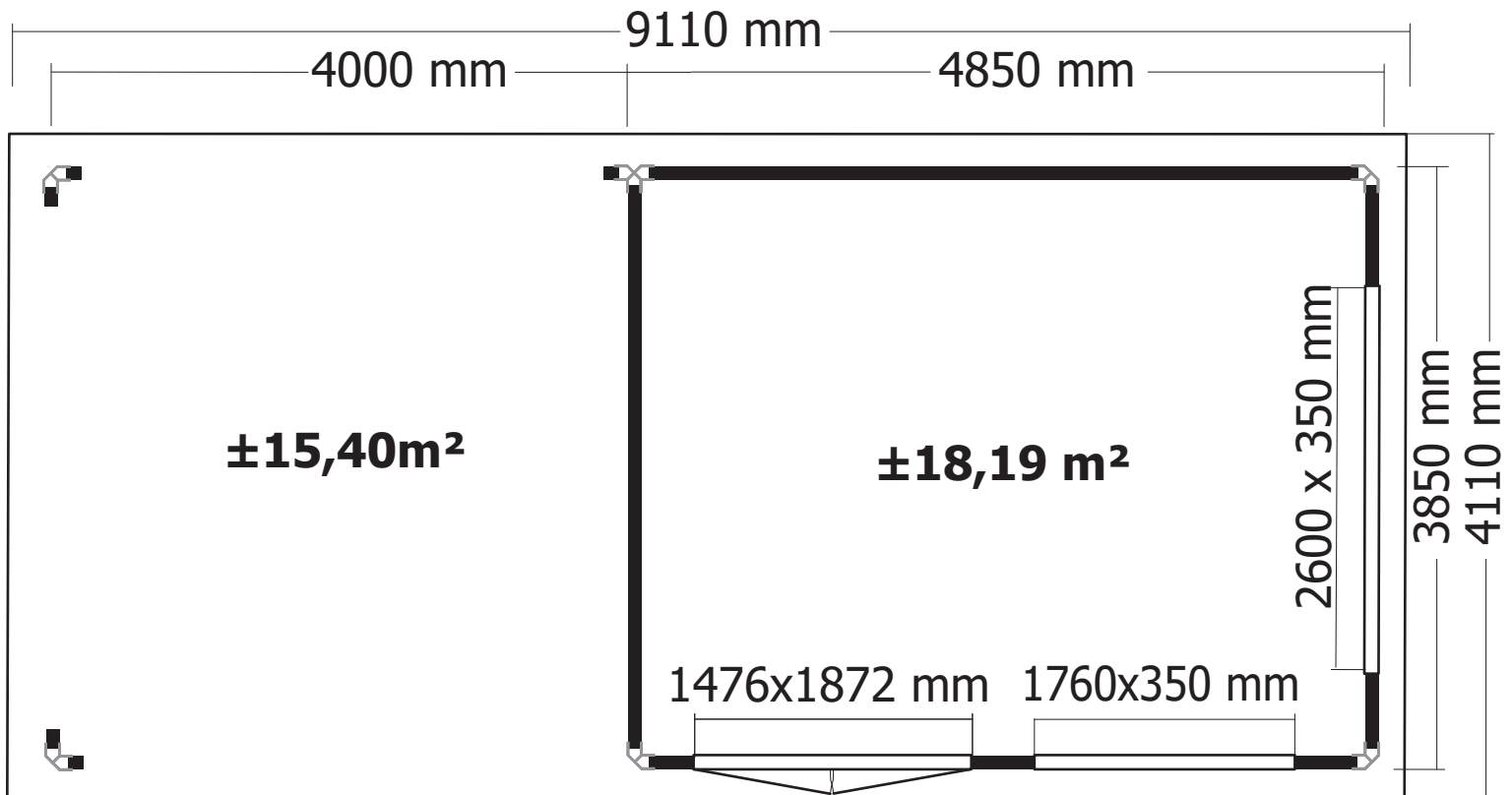

**OPGELET** : Behandel **ELK** onderdeel grondig aan alle zijden met een degelijk product dat beschermt tegen zon, weer en wind en tegen insecten en schimmels, **VOOR** de montage.

**ATTENTION** : Traitez à fond **CHAQUE** élément avec un produit protégeant contre les intempéries, les insectes et les moisissures intérieur et extérieur, **AVANT** le montage .

## B/5105AC

aantal / nombre

Stormset (4st) - Set anti-tempête (4pcs)  
(Ref = 300002)



1

Slot - Serrure (knoblock 28-45mm)  
(Ref = 333005)

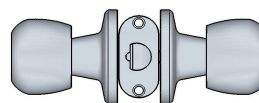

1

Scharnier paumelle groot - Charnière paumelle grand  
(Ref = 300014)

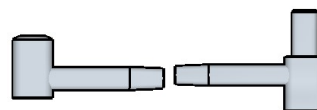

8 set

Kantschuif - Pêne (120mm)  
(Ref = 300019)



2

Hoekijzer groot - Equerre grand (60x60x40)  
(Ref = 300024)

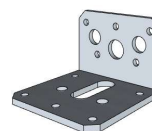

2

Hoekijzer lang - Equerre longue (60x30x30)  
(Ref = 300025)

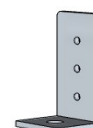

4

Hoekijzer T - Equerre T (80x50x50)  
(Ref = 300023)



14

MDF - MDF (6mm)  
(Ref = 800002)



4

## Schroeven - Vis

Zelftappende schroef - Vis auto-perceuse  
(Ref = 310003)



4

25mm  
(Ref = 310018)



42

35mm  
(Ref = 310007)



188

50mm  
(Ref = 310013)



26

70mm  
(Ref = 310009)



40

Schroef + kapje - Vis + capuchon (100mm)  
(Ref = 310005 & 399007)

155



## B/5130AB4040

aantal / nombre

Hoekijzer lang - Equerre longue (60x30x30)  
(Ref = 300025)

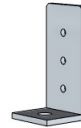

2

Hoekijzer klein - Equerre petit (30x30x30)  
(Ref = 300026)

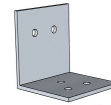

4

MDF - MDF (6mm)  
(Ref = 800002)



4

### Schroeven - Vis

Zelftappende schroef - Vis auto-perceuse  
(Ref = 310003)



10

25mm

(Ref = 310018)

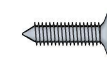

28

35mm

(Ref = 310007)



66

50mm

(Ref = 310013)



8

70mm

(Ref = 310009)



16

Schroef + kapje - Vis + capuchon (100mm)  
(Ref = 310005 & 399007)



88



# HDB/SET21

Voor artikel / Pour article:

5105

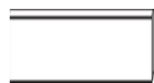
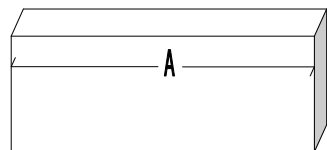

| <u>ARTIKEL NR</u><br><u>NR ARTICLE</u> | <u>AANTAL</u><br><u>NOMBRE</u> | <u>FUNCTIE</u><br><u>FONCTION</u>     |
|--|--------------------------------|---------------------------------------|
| P1/0118                                | 8                              | hulpdakbalk / poutre de toit d'aide   |
| P1/0167                                | 5                              | hulpdakbalk / poutre de toit d'aide   |
| S/013/044/0101                         | 2                              | hulpdakbalk / poutre de toit d'aide   |
| S/026/044/0101                         | 2                              | hulpdakbalk / poutre de toit d'aide   |
| S/040/044/0101                         | 7                              | hulpdakbalk / poutre de toit d'aide   |
| SSL/0230                               | 7                              | sierlat / latte de finition           |
| HSL/0230                               | 4                              | sierlat hoek / latte de finition coin |

**Voor artikel / Pour article:**

5130AB4040

# HDB/SET23

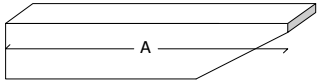
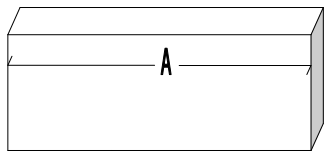

| <u>ARTIKEL NR</u><br><u>NR ARTICLE</u> | <u>AANTAL</u><br><u>NOMBRE</u> | <u>FUNCTIE</u><br><u>FONCTION</u>   |
|--|--------------------------------|-------------------------------------|
| P1/0167                                | 4                              | hulpdakbalk / poutre de toit d'aide |
| 599901                                 | 4                              | hulpdakbalk / poutre de toit d'aide |
| SSL/0230                               | 2                              | sierlat / latte de finition         |