



## DE Aufbauanleitung Gerätehaus „Europa“

- Ⓞ GB Assembly manual for garden shed "Europa"
- Ⓞ FR Notice de montage pour l'abri de jardin "Europa"
- Ⓞ NL Opbouwbeschrijving berging "Europa"
- Ⓞ ES Instrucciones de montaje de la caseta "Europa"
- Ⓞ IT Istruzioni di montaggio Casetta portattrezzi "Europa"
- Ⓞ DK Monteringsvejledning for redskabsskuret "Europa"



 Poišćite vař prevod na ...

 Najděte svůj překlad ...

 Hitta din översättning ...

 Finn din oversettelse ...

 Találja meg fordítását ...



## Wichtige Punkte für den Aufbau!

Vorliegende Aufbauanleitung zeigt den Zusammenbau von Gerätehaus „Europa“ Größe „3“; sie gilt sinngemäß auch für alle anderen Größen. Für einige Montageschritte benötigen Sie 1 bis 2 Helfer.

- GB *Important details regarding assembly! This assembly manual shows the erection of the garden shed model "Europa" size "3"; in the general sense it is valid for all sizes. For several assembly steps additional assistance of 1 or 2 persons will be required.*
- FR *Points importants lors du montage! Cette notice de montage décrit l'assemblage de l'abri "Europa" taille « 3 »; celle-ci est valable pour toutes les tailles. Pour certaines étapes, demandez l'aide d'une ou deux personnes.*
- NL *Belangrijke punten voor de montage! Deze montage instructies hebben betrekking op de opbouw van de "Europa", grootte 3, De instructies zijn van toepassing op alle maten. Voor enkele montage stappen heeft u 1 of 2 extra mensen nodig.*
- ES *Notas importantes para el montaje! Estas instrucciones muestran el montaje de la caseta "Europa" en tamaño 3; Son válidas para todos los tamaños. Es recomendable realizar el montaje entre dos o tres personas.*
- IT *Indicazioni importanti per il montaggio! Le seguenti istruzioni di montaggio fanno riferimento all'assemblaggio di "Europa" misura "3"; in senso generale è valido per tutte le misure. Per alcune fasi di assemblaggio vi serviranno 1 - 2 aiutanti.*
- DK *Vigtige punkter ved samling! Samlemanualen viser opsætningen af havekur modellen "Europa" str. "3"; fremgangsmåde er også tilsvarende for øvrige størrelser. Ved flere punkter af opsætningen er yderligere hjælp påkrævet af 1 eller 2 personer.*



## Um Kratzer zu vermeiden, verwenden Sie bitte geeignete Unterlagen!

- GB *Please use a suitable underlay to avoid scratches!*
- FR *Pour éviter les rayures, utilisez les supports appropriés!*
- NL *Om krassen te voorkomen raden wij u aan er iets onder te leggen!*
- ES *Por favor, coloque en el suelo una base protectora adecuada para evitar posibles arañazos.*
- IT *Utilizzare una base adatta per evitare graffi!*
- DK *Benyt ventligst et passende underlag for at undgå skrammer!*



## Schraubverbindungen grundsätzlich erst am Ende der Montage festziehen!

- GB *Nuts not to be tightened before the end of assembly!*
- FR *Ne serrer les écrous à fond qu'à la fin du montage!*
- NL *Schroeven pas aan het einde van de montage vastdraaien!*
- ES *En principio, no apriete fijamente las tuercas hasta que no haya terminado de montar la caseta.*
- IT *I dadi devono essere serrati a fondo soltanto alla fine del montaggio!*
- DK *Møtrikkerne må ikke strammes før slutningen af opsætningen!*

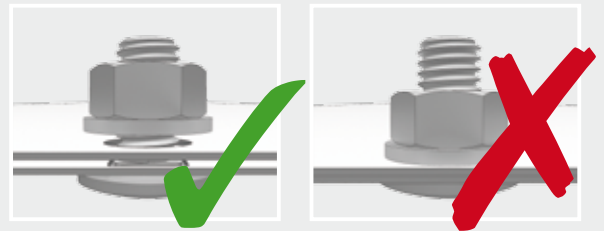

## Wasserwaagen - Symbol:

Betreffendes Einbauteil mit der Wasserwaage ausrichten.

- GB *Symbol of spirit level: Align the respective parts by using the spirit level.*
- FR *Symbole niveau à bulle : lorsque ce symbole apparaît, vous devez ajuster l'élément à l'aide d'un niveau à bulle.*
- NL *Waterpas - symbol: Bij montageschappen waar dit symbool bijstaat is het noodzakelijk het betreffende onderdeel waterpas in te bouwen.*
- ES *Símbolo del nivelador: Indica que se debe ajustar y centrar la pieza con la ayuda de un nivelador.*
- IT *Simbolo di livella a bolla d'aria: Allineare il componente in questione con l'ausilio di una livella a bolla d'aria.*
- DK *Symbol for vaterpas: Juster de respektive dele ved hjælp af vaterpas.*

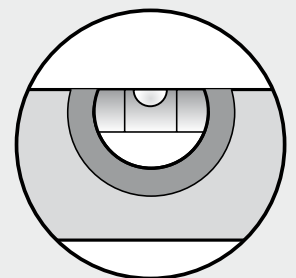

## Optionales Zubehör - Symbol:

Arbeitsschritte, die blau eingerahmt sind, zeigen den Einbau eines optionalen Zubehörteiles.

- GB *Symbol of optional accessories: Blue framed assembly steps show the installation of optional accessories.*
- FR *Accessoires en option-Symbole: La trame entourée en bleu indique une étape avec accessoires en option. A réaliser uniquement si vous avez commandé cet accessoire.*
- NL *Extra Toebehoor: Montageschappen met een blauwe rand betreffen de inbouw van extra toebehoor.*
- ES *Accesorio opcional - símbolo: Los pasos de montaje que se encuentran enmarcados en azul muestran el montaje de una pieza de un accesorio opcional.*
- IT *Simbolo per accessori opzionali: Le fasi del montaggio incorniciate in colore azzurro mostrano l'installazione di un accessorio opzionale.*
- DK *Symbol for ekstra udstyr: Blåt indrammet samletrin viser installationen af ekstraudstyr*



optionales Zubehör - Accesso...

## Bodenrahmen

Floor Frame - Cadre de sol



## Größenabhängiger Montageschritt!

- (GB) *Size-Dependent assembly step!*
- (FR) *L'étape d'assemblage dépend de la taille de l'abri!*
- (NL) *Montage stap afhankelijk van de grootte!*
- (ES) *Paso de montaje dependiente del tamaño de la caseta!*
- (IT) *Misura-dipendente fase di montaggio!*
- (DK) *Størrelses-afhængig montage skridt*



Größenabhängiger Montageschritt

## Nur für Größe 2A

Only for size 2A- Uniquement pour taille 2A



## Nicht bei Wind aufbauen!

- (GB) *Do not assemble the shed on a windy day!*
- (FR) *Ne pas assembler quand il y a du vent !*
- (NL) *Niet bij wind opbouwen!*
- (ES) *No monte la caseta si hace mucho viento.*
- (IT) *Non montare la casetta in giornate di vento!*
- (DK) *Saml ikke skuret på en blæsende dag!*



## Verwenden Sie bei der Montage Arbeitshandschuhe!

- (GB) *Wear working gloves!*
- (FR) *Portez des gants de travail!*
- (NL) *Handschoenen gebruiken!*
- (ES) *Utilice unos guantes de trabajo.*
- (IT) *Utilizzare guanti da lavoro*
- (DK) *Brug arbejdshandsker!*



## Pflege und Wartung

- Keine aggressiven Chemikalien wie z.B. Chlor oder Streusalz lagern!
- Sonnenmilch und andere Cremes mit Wasser und Seife entfernen.
- Keine scheuernden Reinigungsmittel verwenden!
- Laub vom Dach regelmäßig entfernen!
- Dachrinnenauslauf kontrollieren!
- Tiefe Kratzer sofort mit beiliegendem Lack ausbessern!
- Ölen Sie das Schloss jährlich!

## (EN) Care and maintenance

- *Do not store aggressive substances i.e. chlorine or road salt!*
- *Remove suntan lotion or any other creams with water and rinse aid!*
- *Do not use abrasive cleaning agents!*
- *Keep the roof free of leaves!*
- *Check the gutter!*
- *Touch-up scratches immediately with the paint provided.*
- *Lubricate the lock once a year!*

## (FR) Entretien et maintenance

- *Ne pas stocker de produits chimiques (chlore, sel, etc...)!*
- *Nettoyez uniquement avec de l'eau les crèmes solaires et autres crèmes (pas de nettoyant chimique).*
- *Ne pas utiliser de produits nettoyant abrasifs!*
- *Débarrassez vous régulièrement des feuilles mortes sur le toit!*
- *Contrôlez l'évacuation de la gouttière!*
- *Corrigez immédiatement les rayures avec la laque jointe!*
- *Graissez la serrure et les charnières chaque année!*

## (NL) Onderhoud

- *Geen chemicaliën in de berging opslaan!*
- *Zonnebrandolie/melk en andere cremes met water en glansmiddel verwijderen.*
- *Gebruik geen schuurmiddelen!*
- *Regelmatig bladeren van dak verwijderen!*
- *Dakgootuitloop controleren.*
- *Krassen direct met de meegeleverde lak behandelen.*
- *Slot jaarlijks oliën*

## (ES) Cuidado y mantenimiento

- *No almacene productos químicos agresivos dentro de la caseta como por ejemplo cloro y sal antiescarcha.*
- *Evite dejar huellas o restos de cremas solares sobre la chapa. Limpie la caseta siempre con agua y jabón.*
- *No utilice ningún producto para fregar. En general, evite siempre cualquier producto químico para limpiar la caseta.*
- *Mantenga el tejado libre de hojas secas. Controle el desagüe del canalón.*
- *Repare los arañazos lo antes posible con el barniz que se incluye.*
- *Aplique aceite en la cerradura y las bisagras una vez al año.*

## (IT) Manutenzione

- *Non lasciare prodotti chimici aggressivi (come ad esempio cloro o sale per strade) all'interno della casetta!*
- *Rimuovere crema solare e altre creme con acqua e brillantante!*
- *Non utilizzare detergenti contenenti sostanze aggressive!*
- *Mantenere il tetto libero da foglie!*
- *Controllare la grondaia!*
- *Ritoccare immediatamente eventuali graffi con la vernice fornita nella confezione!*
- *Lubrificare la serratura e le cerniere a cadenza annuale!*

## (DK) Pleje og vedligeholdelse

- *Opbevar ikke aggressive stoffer dvs. Klor eller vejsalt!*
- *Fjern solcreme eller andre typer af creme med vand og rensmiddel!*
- *Brug ikke aggressive rengøringsmidler!*
- *Hold taget fri for blade!*
- *Kontroller rendestenen!*
- *Ved skrammer, brug straks malingen som er stillet til rådighed!*
- *Smør låsen årligt!*



## ACHTUNG: Im Sommer können im Innenraum sehr hohe Temperaturen entstehen!

- (GB) Attention: during the summer high temperature might arise in the interior.
- (FR) Attention : en été la température à l'intérieur de l'abri peut être élevée!
- (NL) Let op: in de zomer kunnen in de berging zeer hoge temperaturen bereikt worden.
- (ES) Tenga en cuenta que en el verano las temperaturas en el interior pueden ser altas.
- (IT) Attenzione: Si prega di prendere nota che in estate si possono essere temperature molto elevate all'interno.
- (DK) Vigtigt: Der kan opstå meget høje temperaturer i skuret om sommeren.

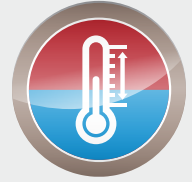

## Nagel - Symbol:

Bitte verwenden Sie den beiliegenden Nagel, um die Löcher der einzelnen Bleche auszurichten.

- (GB) Symbol of nail: Please use the attached nail to align the holes of each sheet.
- (FR) Symbole clou : veuillez utiliser le clou fourni pour aligner les trous sur chaque paroi.
- (NL) Spijker-symbool: Bij montageschappen waar dit symbool bijstaat dient de spijker voor het laten corresponderen van 2 Schroefgaatjes.
- (ES) Símbolo del clavo: Utilice los clavos suministrados para alinear los orificios de cada chapa.
- (IT) Simbolo del chiodo: Si prega di utilizzare il chiodo incluso per allineare i buchi di ogni lamiera.
- (DK) Søm-symbol: Brug de medfølgende søm til at rette hullerne på de enkelte plader ind



## Vorschläge für das Fundament

Bitte achten Sie bei der Fundamentgestaltung darauf, dass Niederschlagswasser nicht seitlich unter den Bodenprofilen in das Gerätehaus eindringen kann! (siehe Varianten 1, 2, 3). Aufsteigende Bodenfeuchtigkeit und Kondensation vermeiden Sie mittels einer starken Kunststoffolie unter dem Fundament.

### (GB) **Proposals for a secure foundation**

When making the foundation arrangements please take necessary precaution to ensure that water cannot leak in under the floor profiles (see option 1, 2, 3). Rising ground moisture and condensation can be avoided by using a strong plastic sheet underneath the paving slabs or underneath the concrete foundation.

### (FR) **Conseils pour les fondations**

Lors de la réalisation de la fondation, veillez à ce que l'eau de pluie ne puisse pas pénétrer dans l'abri ou par les côtés sous les profils de sol (voir variantes 1, 2, 3). Vous pouvez éviter l'humidité du sol et la condensation en mettant un film plastique épais sous les plaques de béton.

### (NL) **Voorstellen voor fundament**

Let er bij het maken van de fundering op dat regenwater niet onder het bodemprofiel kan doorlopen (zie voorbeeld 1, 2, 3). Een vochtige bodem en condensatie kunt u vermijden door het aanbrengen van een sterke kunststoffolie onder de tegels of het betonfundament.

### (ES) **Medidas y recomendaciones para los cimientos:**

Al colocar los cimientos, asegúrese de que el agua de lluvia no puede penetrar en la caseta por los laterales debajo del perfil del suelo (véase variante 1, 2 y 3). Evite la humedad y la condensación en el suelo colocando una lámina de plástico bajo las losas o los cimientos de hormigón.

### (IT) **Proposte per il basamento:**

Il basamento deve essere progettato in modo da evitare infiltrazioni di acqua piovana all'interno della casetta (vedere proposta 1-2-3). Un telo di plastica spesso posto in corrispondenza dell'area di pavimento evita infiltrazioni di umidità dal terreno e la formazione di condensa.

### (DK) **Forslag til sikkert fundament:**

Ved etablering af fundament skal du tage de nødvendige forholdsregler for at sikre, at vand ikke kan sive ind under gulvprofilerne (se mulighed 1, 2, 3). Stigende fugt og kondens i jorden kan undgås ved at bruge plastik under flisebelægningen eller under betonfundamentet.



Weitere Details betreffend Fundament finden Sie auch unter [www.biohort.com/Fundament](http://www.biohort.com/Fundament)

Further details about foundations you will find on [www.biohort.com/foundation](http://www.biohort.com/foundation)

Pour des détails supplémentaires, veuillez consulter [www.biohort.com/foundations](http://www.biohort.com/foundations)

Verdere details over het fundament vindt u ook op [www.biohort.com/fundament](http://www.biohort.com/fundament)

Encuentre información detallada sobre los cimientos en: [www.biohort.com](http://www.biohort.com) > servicios > cimientos

Per ulteriori dettagli si prega di consultare [www.biohort.com/it/servizi/suggerimenti-per-le-fondamenta/](http://www.biohort.com/it/servizi/suggerimenti-per-le-fondamenta/)

Yderligere informationer om fundamentet finder du på [www.biohort.com/foundation](http://www.biohort.com/foundation)



# Maße für das Fundament

(GB) Foundation dimensions

(FR) Dimensions pour la fondation

(NL) Maat voor het fundament

(ES) Medidas de los cimientos

(IT) Dimensioni del basamento

(DK) Fundament dimensioner

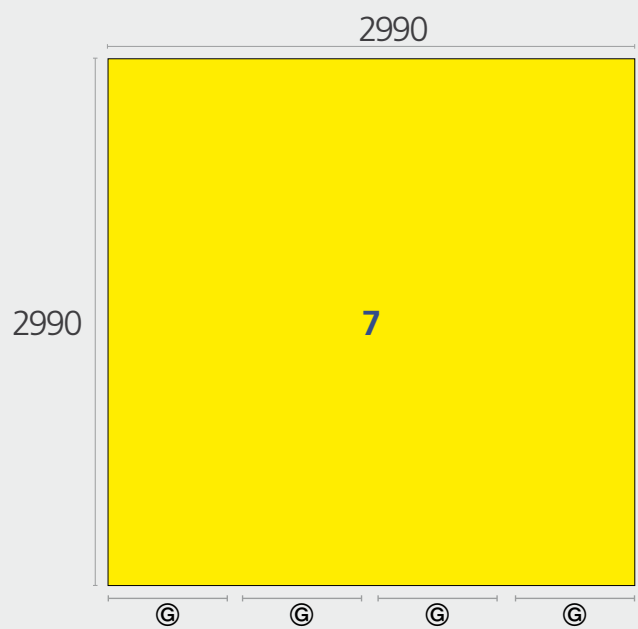
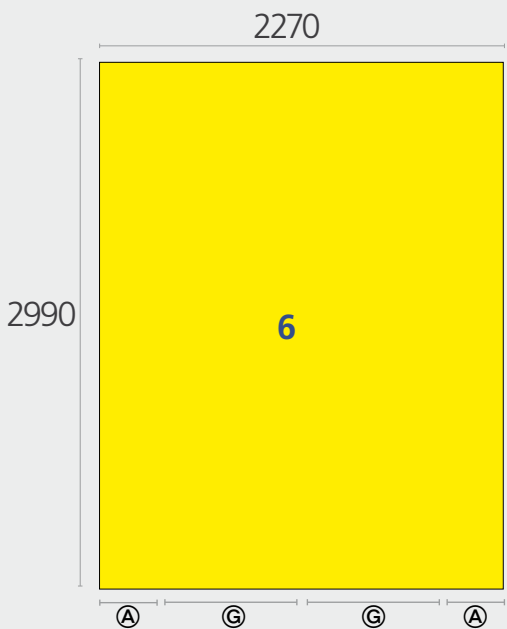
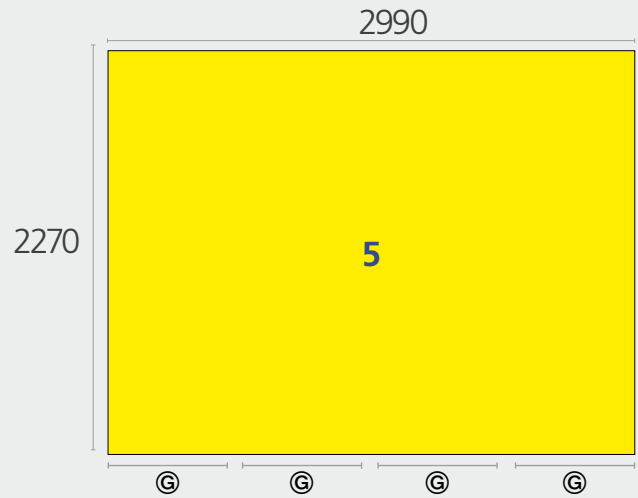
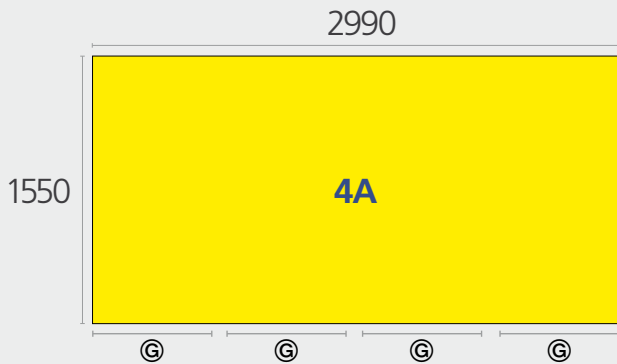
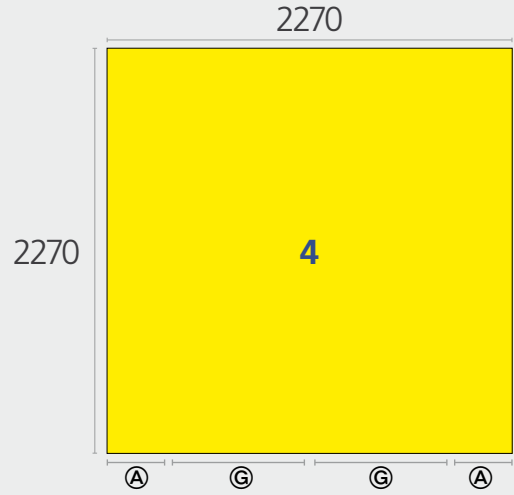
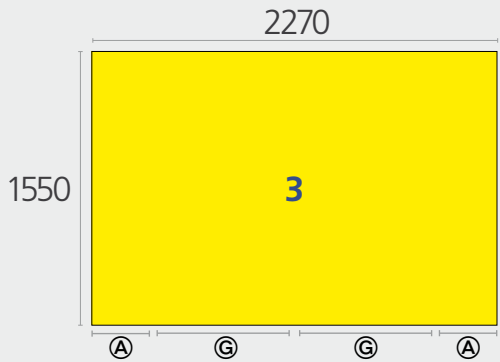
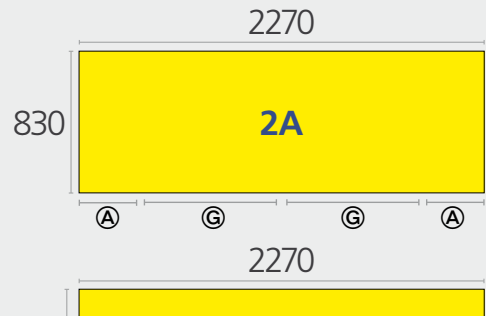
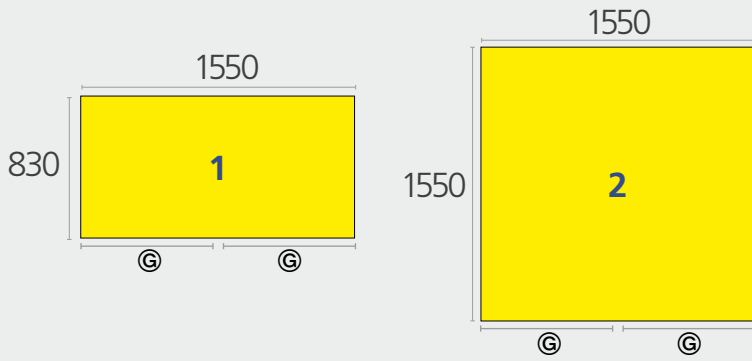



**ACHTUNG** ATTENTION  
ATTENTION | ATTENTIE |  
ATENCIÓN | ATTENZIONE |  
OBS.



**Die Verankerung ist wichtig, denken Sie an Sturmböen!**

*Do not forget to anchor the shed against gale force wind!*

*L'ancrage est important, pensez aux rafales de vent!*

*Verankering niet vergeten!*

*El anclaje es muy importante. Piense por ejemplo en rachas fuertes de viento.*

*L'ancoraggio della casetta è importante - pericolo in caso di raffiche di vento!*

*Glem ikke at forankre skuret mod vinde af stormstyrke*

## Variante, Proposal, Variant 1

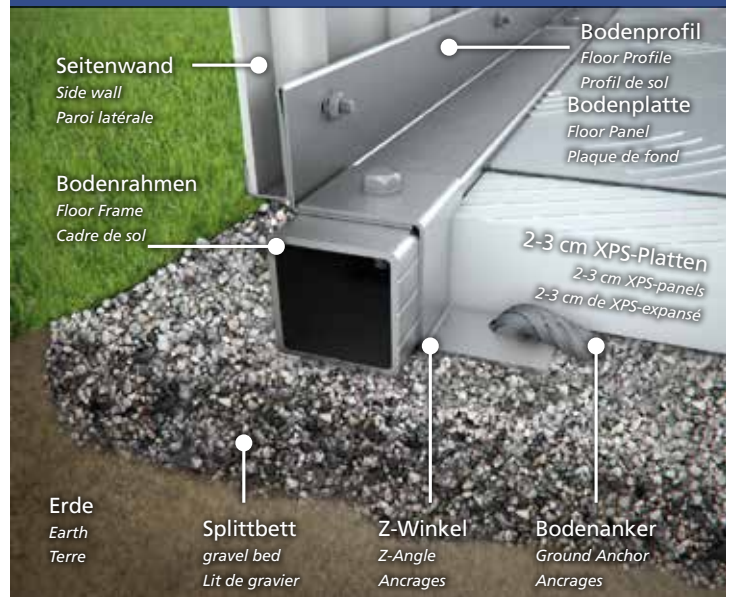

## Variante, Proposal, Variant 2

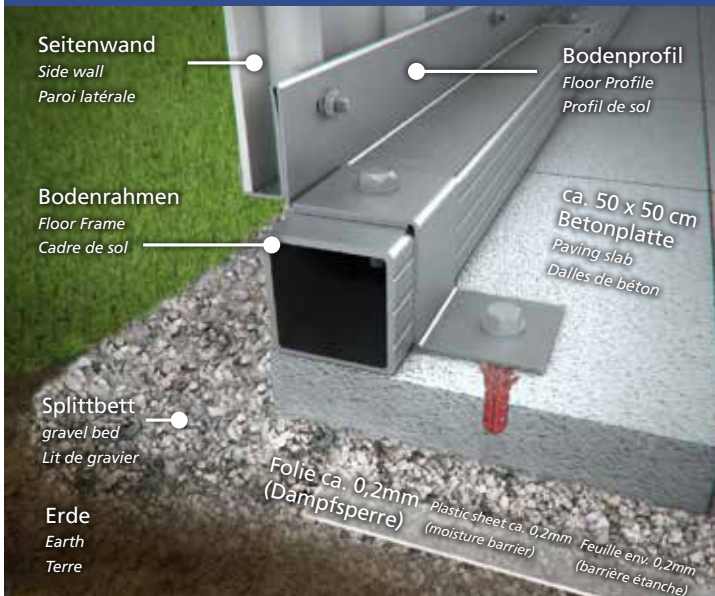

## Variante, Proposal, Variant 3

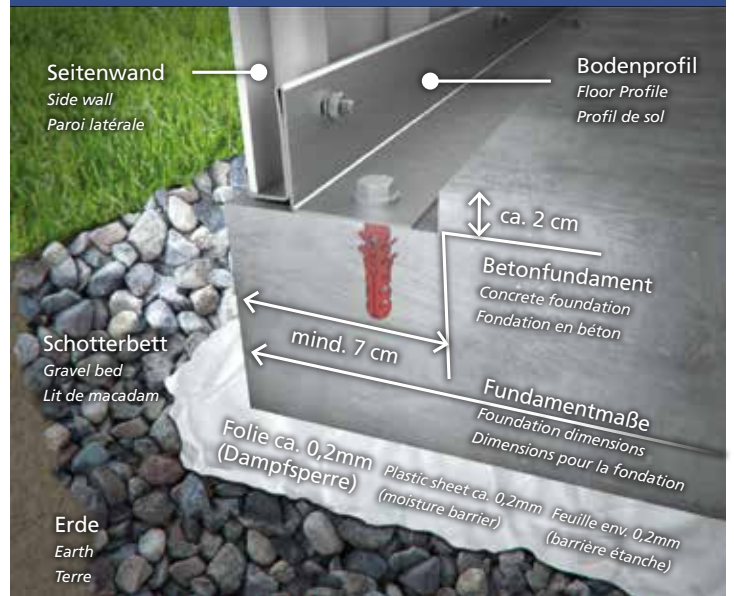

## Maßstabsgetreue Abbildung der zu verwendenden Schrauben:

(GB) Scale drawing 1:1 of the screws in use

(FR) Reproduction selon l'échelle 1:1.

(NL) Afbeelding : schaal 1:1 (ware grootte)

(ES) Reproducción a escala 1:1 de los tornillos que se utilizan para el montaje.

(IT) Immagine in scala delle viti da utilizzare!

(DK) Skala tegning af skruer er 1:1

**M 1:1**

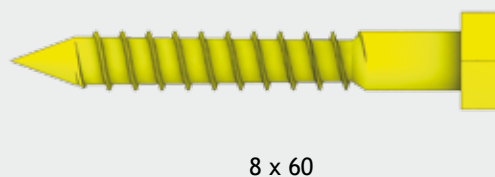
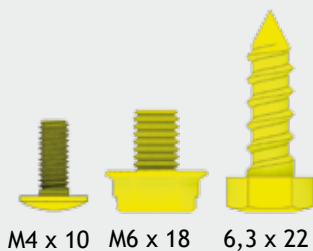

M4 x 10 M6 x 18 6,3 x 22

8 x 60

## 1 Paket Nr. 1

Türpaket · Doorpackage · Carton de portes · Deurpakket · Kit de puerta · Pacco porta · Dørpakke

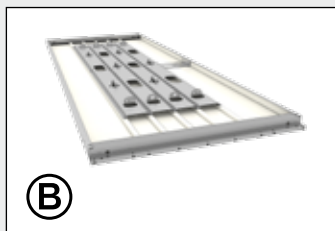
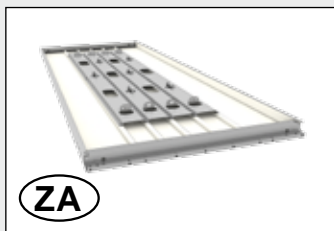

## 2 Paket Nr. 2

Seitenwandpaket · Side panel package · Carton de parois latérales · Zijwandpakket · Panel la teral · Pacco pareti laterali · Sidepladepakke

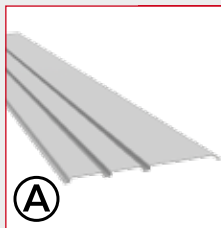

**Nur für Größe 2A, 3, 4, 6**  
 Only for size 2A, 3, 4, 6  
 Uniquement pour les taille 2A, 3, 4, 6  
 Alleen voor grootte 2A, 3, 4, 6  
 sólo para los tamaños 2A, 3, 4, 6  
 solo per misura 2A, 3, 4, 6  
 Kun for størrelse 2A, 3, 4, 6

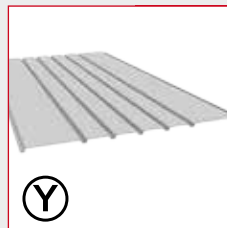
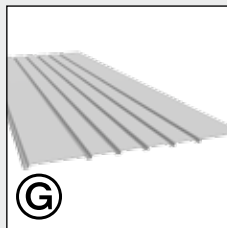

**Nur für Größe 1, 2, 2A, 3, 4A**  
 Only for size 1, 2, 2A, 3, 4A  
 Uniquement pour les taille 1, 2, 2A, 3, 4A  
 Alleen voor grootte 1, 2, 2A, 3, 4A  
 sólo para los tamaños 1, 2, 2A, 3, 4A  
 solo per misura 1, 2, 2A, 3, 4A  
 Kun for størrelse 1, 2, 2A, 3, 4A

## 2a Paket Nr. 2a

Seitenwandpaket · Side panel package · Carton de parois latérales · Zijwandpakket · Panel la teral · Pacco pareti laterali · Sidepladepakke

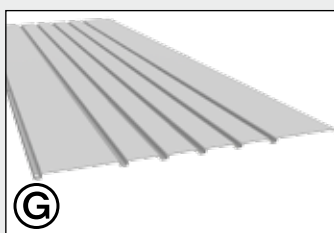

## 3 Paket Nr. 3

Profilpaket · Profile package · Carton de profils · Profielpakket · Kit de perfiles · Pacco profili · Profilpakke

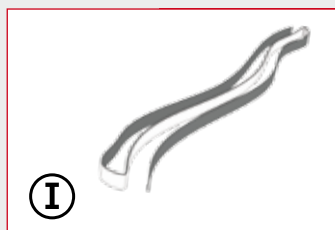
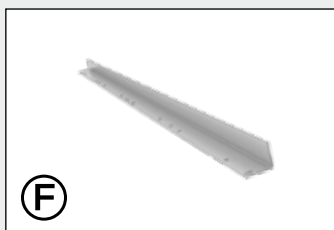
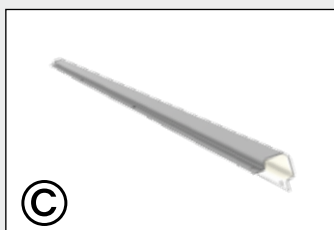

**Nur für Größe 5 und 7**  
 Only for size 5 and 7  
 Uniquement pour les taille 5 et 7  
 Alleen voor grootte 5 en 7  
 sólo para los tamaños 5 y 7  
 solo per misura 5 e 7  
 Kun for størrelse 5 og 7

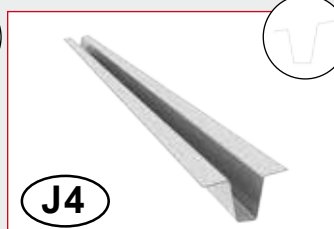
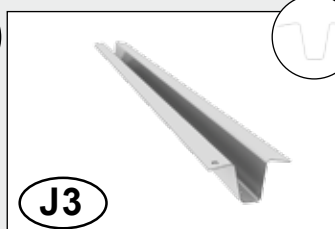
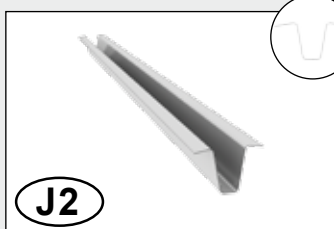
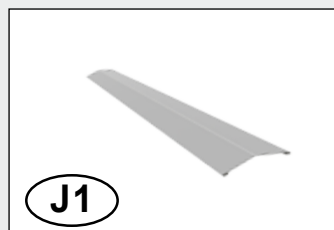

**Nur für Größe 5 und 7**  
 Only for size 5 and 7  
 Uniquement pour les taille 5 et 7  
 Alleen voor grootte 5 en 7  
 sólo para los tamaños 5 y 7  
 solo per misura 5 e 7  
 Kun for størrelse 5 og 7

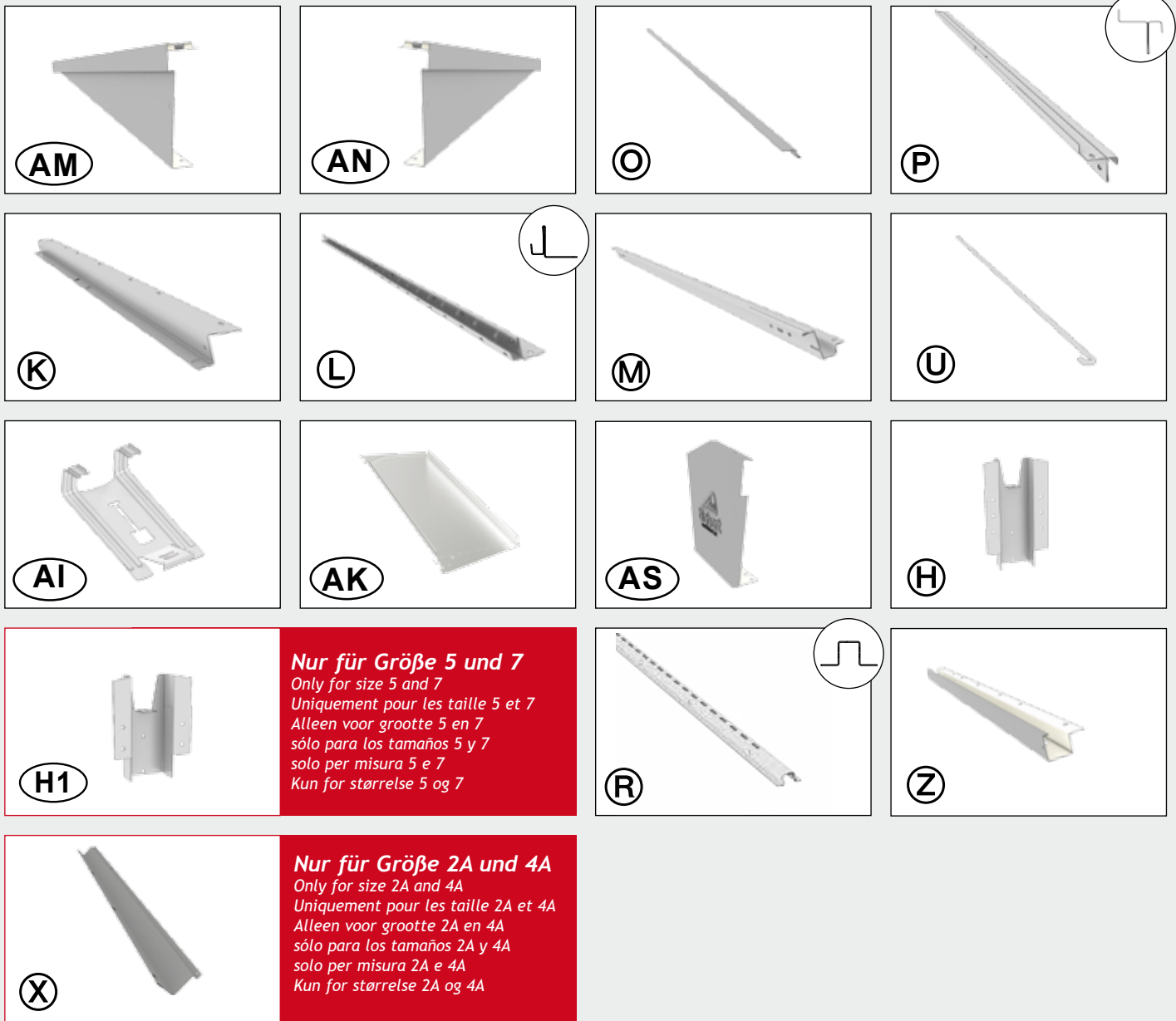

## Paket Nr. 4

Dach-Blechpaket · roof panel package · carton de tôles de toit · dakplaatpakket · kit de paneles del tejado · pacco lamiera tetto · tagpladepakke

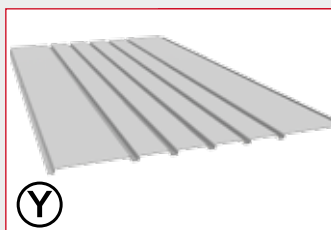

**Nur für Größe 4, 5, 6, 7**  
*Only for size 4, 5, 6, 7*  
*Uniquement pour les taille 4, 5, 6, 7*  
*Alleen voor grootte 4, 5, 6, 7*  
*sólo para los tamaños 4, 5, 6, 7*  
*solo per misura 4, 5, 6, 7*  
*Kun for størrelse 4, 5, 6, 7*

## ! Einbaumöglichkeiten der Türen anstelle von Wandelementen!

- GB** The door can be installed instead of a side wall element!
- FR** La porte peut être installée sur le côté à la place d'une paroi latérale !
- NL** Inbouwmogelijkheden van de deuren i.p.v. de wandelementen
- ES** Es posible colocar las puertas en lugar de los paneles laterales.
- IT** Considerare la possibilità di montare una porta standard al posto di una parete laterale!
- DK** Døren kan monteres i stedet for et sidevæg element!

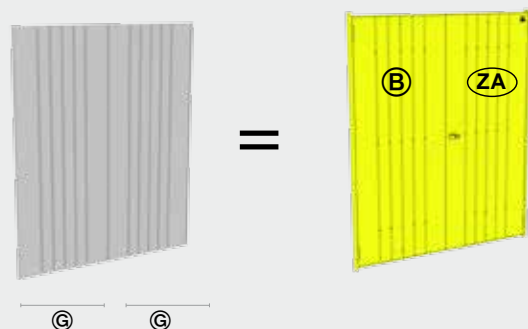





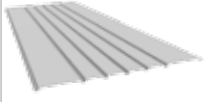

# 1.

## Rückwand

Rear wall - Paroi arrière - Achterwand - Panel posterior - Parete posteriore - Bagplade

 <p>2/2a</p> <p>ⓐ</p>	<p>1: 2x 4A: 4x                  2: 2x 5: 4x                  2A: 3x 6: 3x                  3: 3x 7: 4x                  4: 3x</p>	 <p>ⓐ</p>	<p>3</p> <p>1: 1x 4A: 1x                  2: 1x 5: 1x                  2A: 1x 6: 1x                  3: 1x 7: 1x                  4: 1x</p>	 <p>ⓐ</p>	<p>3</p> <p>1: 1x(1490mm) 4A: 1x(2930mm)                  2: 1x(1490mm) 5: 1x(2930mm)                  2A: 1x(2210mm) 6: 1x(2210mm)                  3: 1x (2210mm) 7: 1x(2930mm)                  4: 1x (2210mm)</p>
 <p>ⓐ</p>	<p>3</p> <p>1: 1x(1490mm) 4A: 1x(2930mm)                  2: 1x(1490mm) 5: 1x(2930mm)                  2A: 1x(2210mm) 6: 1x(2210mm)                  3: 1x (2210mm) 7: 1x(2930mm)                  4: 1x (2210mm)</p>	<p>M4 x 10</p>  <p>ⓐ</p>	<p>1: 8x 4A: 16x                  2: 8x 5: 16x                  2A: 12x 6: 12x                  3: 12x 7: 16x                  4: 12x</p>		

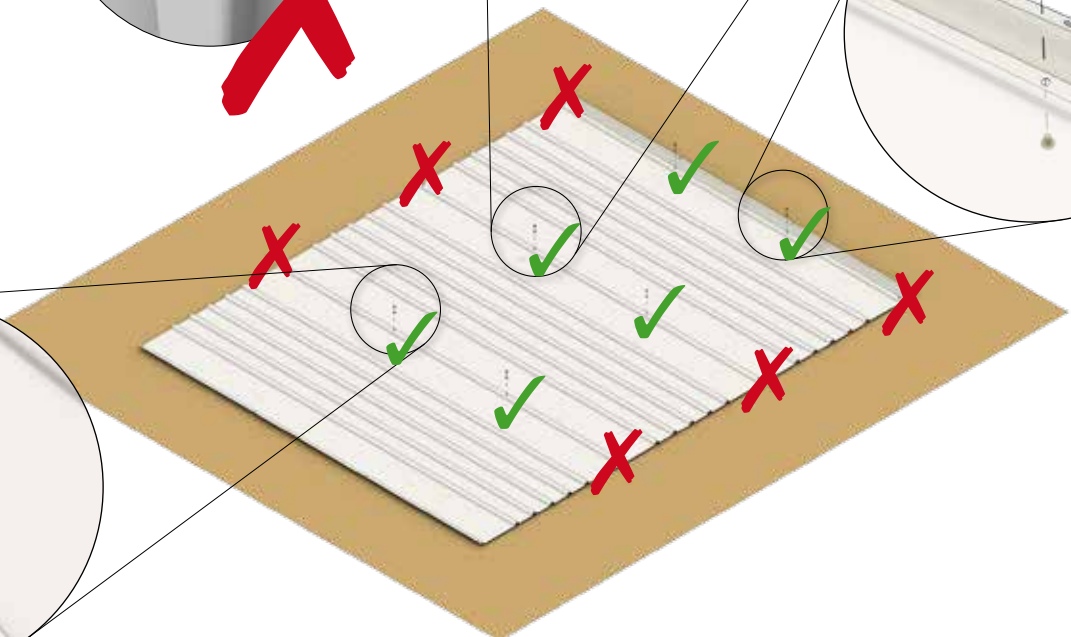
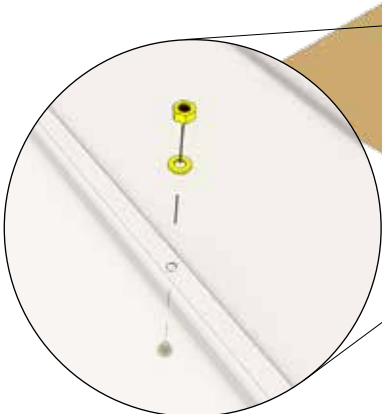
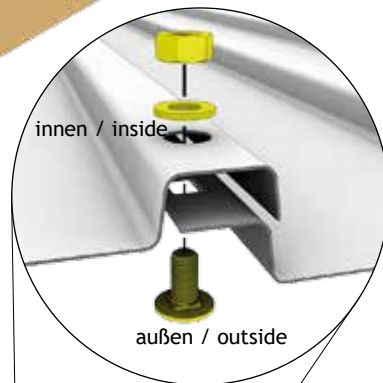
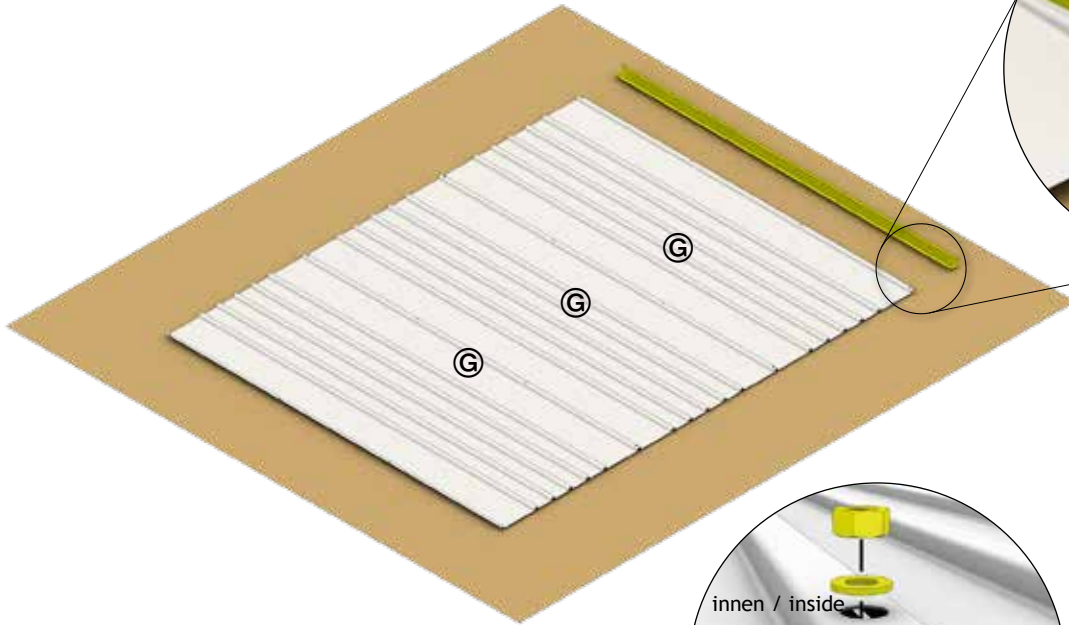

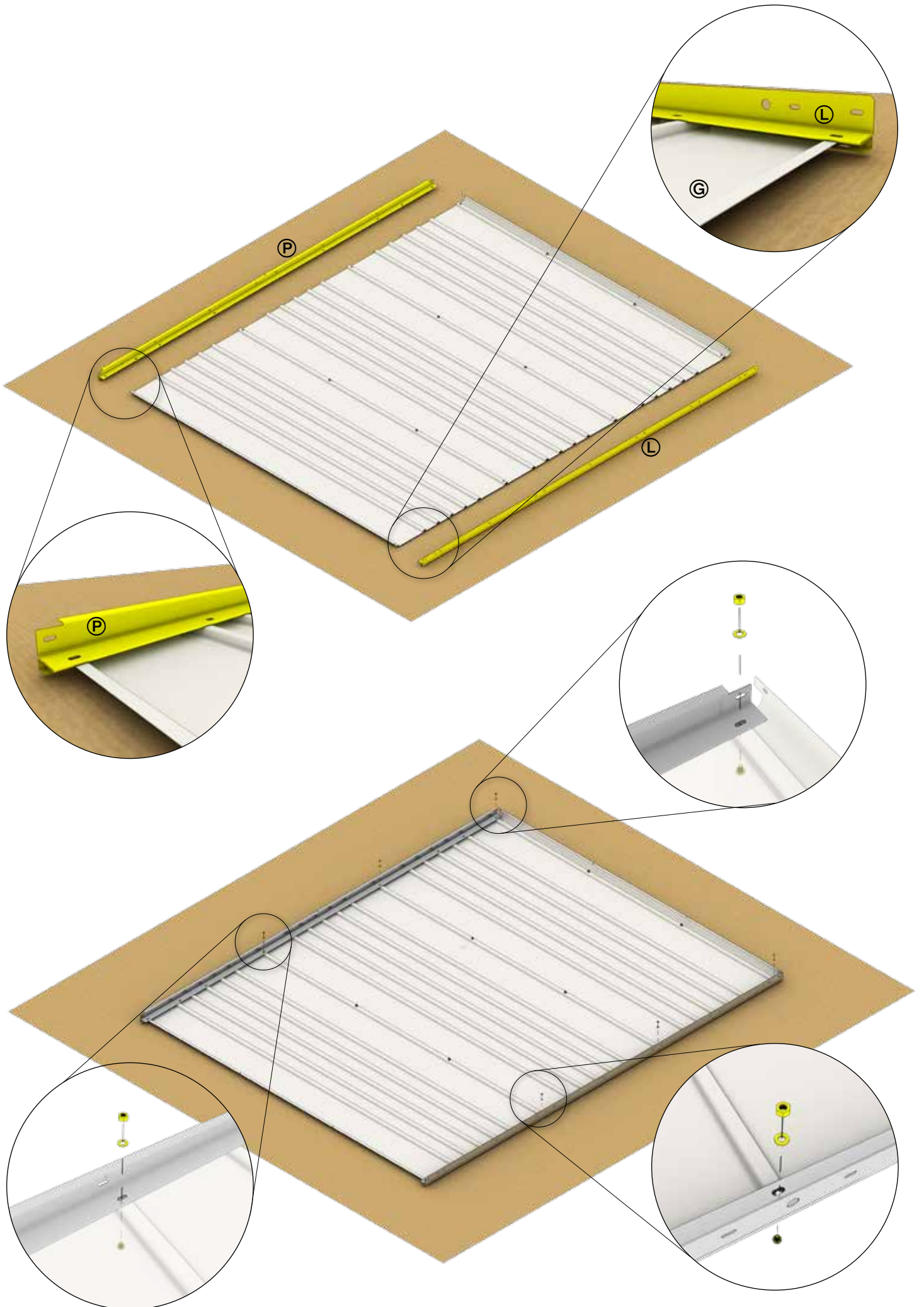





# Nur für Größe 2A-7!

Only for size 2A-7 - Uniquement pour taille 2A-7 - Alleen voor maat 2A-7 - Sólo para los tamaños 2A-7 - Solo per misura 2A-7 - Kun for størrelse 2A-7

**2.**

## Türwand

Door wall - Paroi de la porte - Deurwand - Panel de puerta - Parete della porta - Dørplade

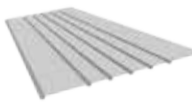

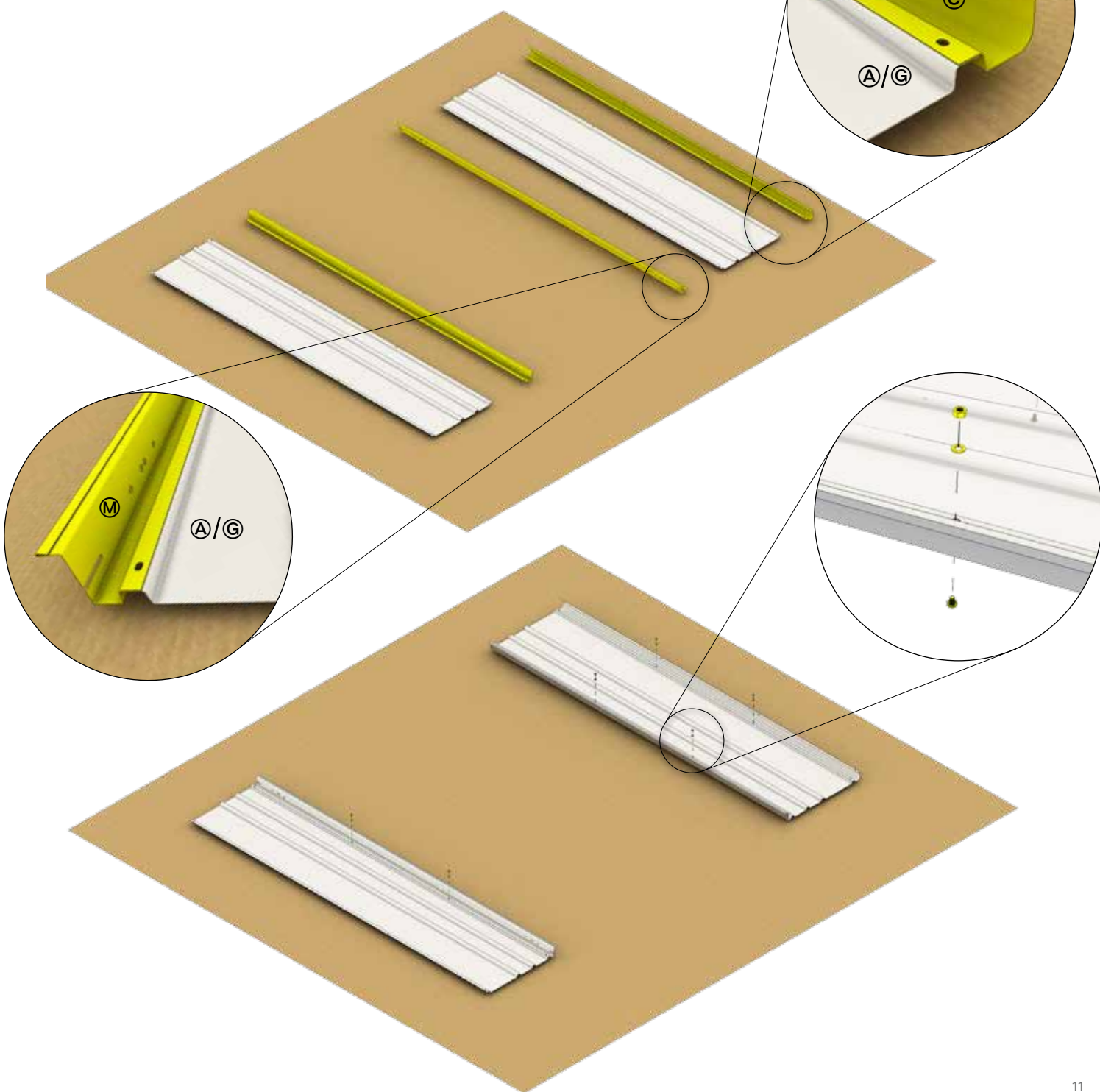



 <p><b>2</b></p> <p>2A: 2x 3: 2x 4: 2x 6: 2x</p> <p><b>A</b></p>		 <p><b>3</b></p> <p>2A: 1x 5: 1x 3: 1x 6: 1x 4: 1x 7: 1x 4A: 1x</p> <p><b>C</b></p>		 <p><b>3</b></p> <p>2A: 2x 5: 2x 3: 2x 6: 2x 4: 2x 7: 2x 4A: 2x</p> <p><b>M</b></p>	
<p>M4 x 10</p>  <p><b>D2</b></p> <p>2A: 6x 5: 6x 3: 6x 6: 6x 4: 6x 7: 6x 4A: 6x</p>		 <p><b>2/2a</b></p> <p>4A: 2x 5: 2x 7: 2x</p> <p><b>G</b></p>			



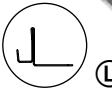

# Nur für Größe 2A-7!





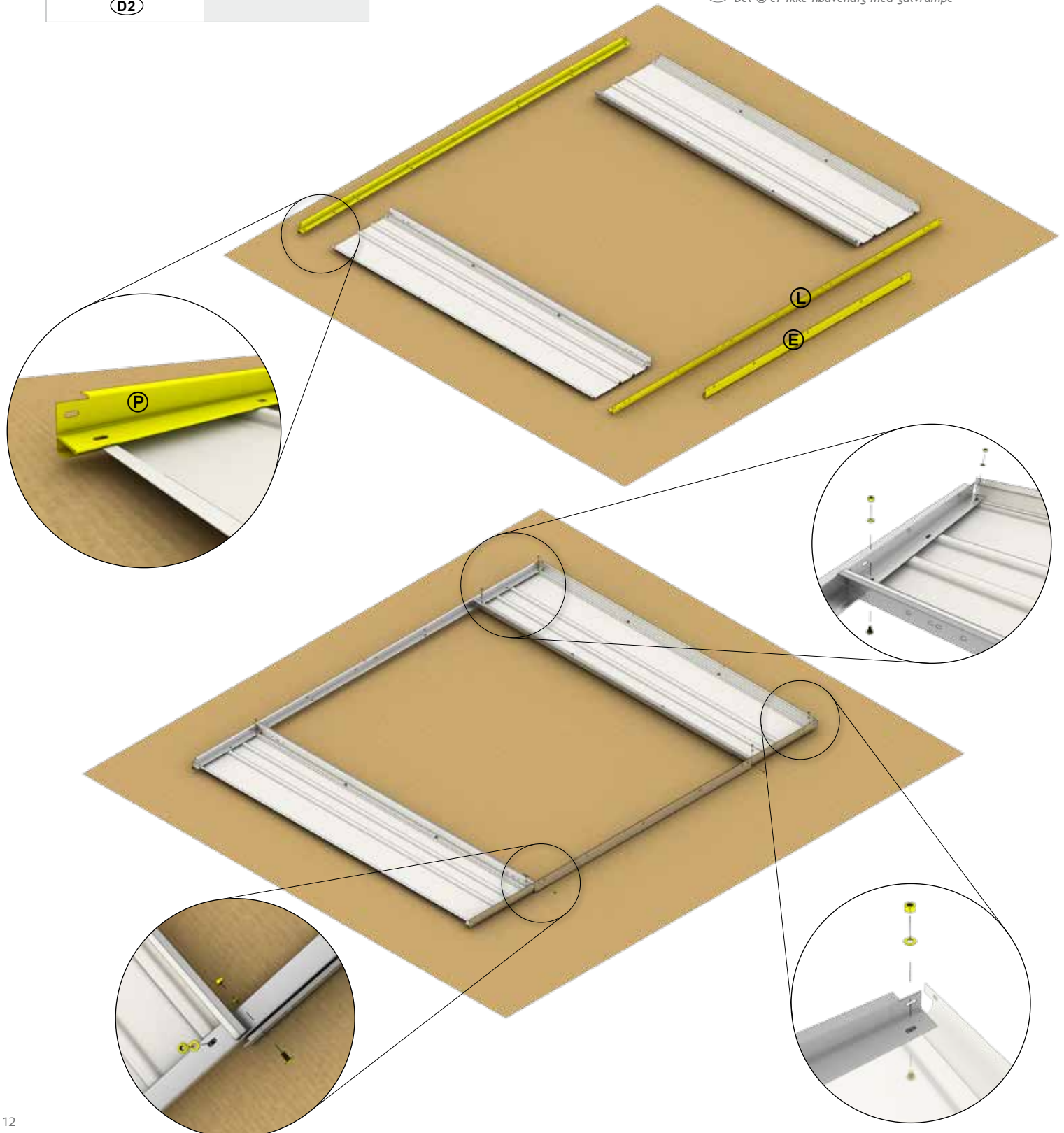

Only for size 2A-7 - Uniquement pour taille 2A-7 - Alleen voor maat 2A-7 - Sólo para los tamaños 2A-7 - Solo per misura 2A-7 - Kun for størrelse 2A-7

  	 2A: 1x    5: 1x 3: 1x    6: 1x 4: 1x    7: 1x 4A: 1x	 1: 1x    4A: 1x 2: 1x    5: 1x 2A: 1x    6: 1x 3: 1x    7: 1x 4: 1x	 2A: 1x    5: 1x 3: 1x    6: 1x 4: 1x    7: 1x 4A: 1x
	M4 x 10   2A: 8x    5: 8x 3: 8x    6: 8x 4: 8x    7: 8x 4A: 8x	<p><b>* Teil ⑥ entfällt bei Bodenschwellenrampe</b></p> <p>                     ⑥ GB Part ⑥ does not apply to threshold access ramp                      ⑥ FR La partie ⑥ ne s'applique pas au seuil de rampe                      ⑥ NL Deel ⑥ is niet van toepassing op Oprijplaat                      ⑥ ES Parte ⑥ no se aplica con la rampa de acceso                      ⑥ IT Parte ⑥ non si applica alla rampa da soglia                      ⑥ DK Del ⑥ er ikke nødvendig med gulvrampe                 </p>	



# Nur für Größe 2A-7!

Only for size 2A-7 - Uniquement pour taille 2A-7 - Alleen voor maat 2A-7 - Sólo para los tamaños 2A-7 - Solo per misura 2A-7 - Kun for størrelse 2A-7

  <b>(D1)</b>	2A: 2x    5: 2x 3: 2x    6: 2x 4: 2x    7: 2x 4A: 2x	  <b>(D1)</b>	2A: 2x    5: 2x 3: 2x    6: 2x 4: 2x    7: 2x 4A: 2x	 <b>(D1)</b>	2A: 4x    5: 4x 3: 4x    6: 4x 4: 4x    7: 4x 4A: 4x
M4 x 10  <b>(D2)</b>	2A: 8x    5: 8x 3: 8x    6: 8x 4: 8x    7: 8x 4A: 8x				

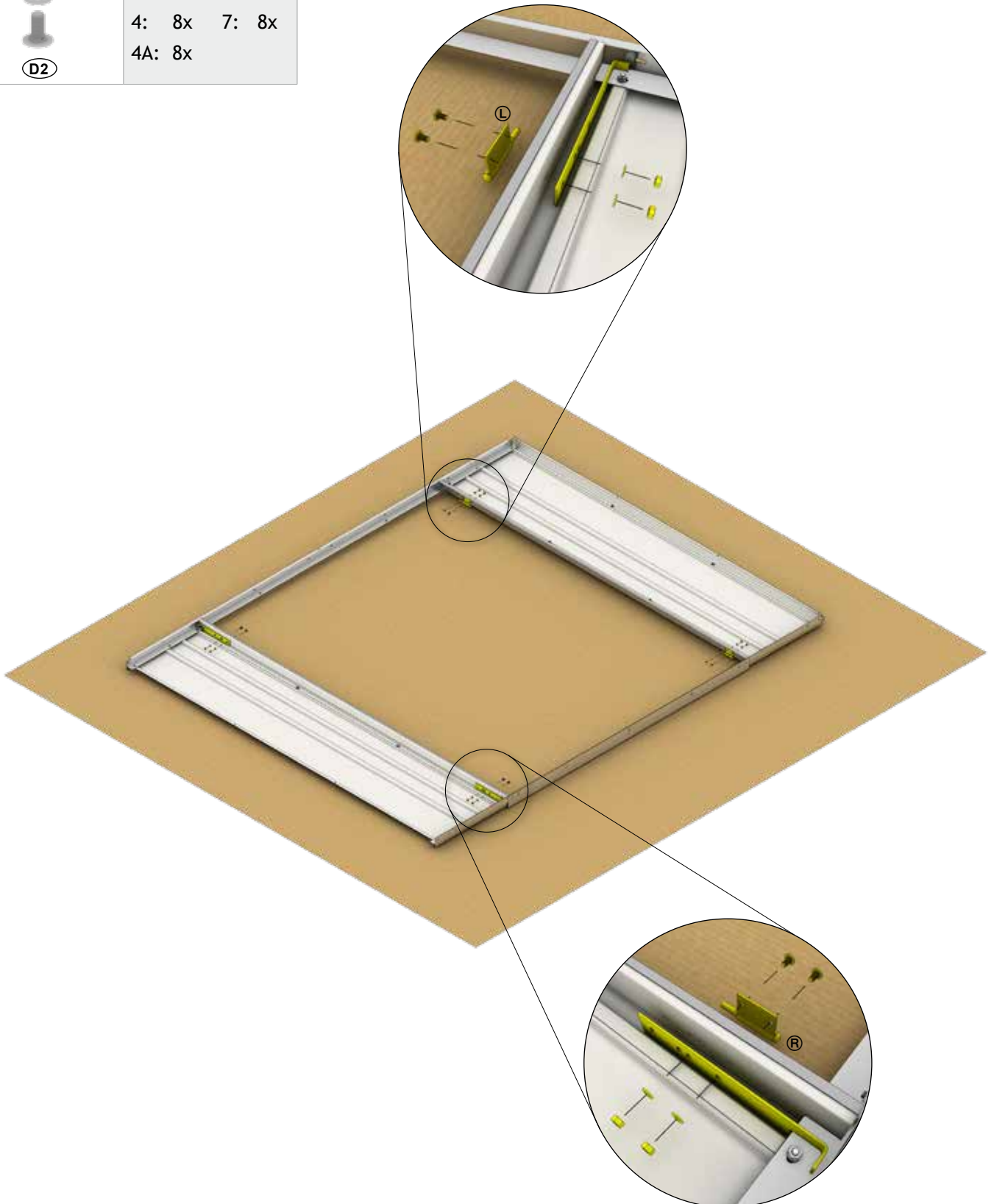





# 3.

## Seitenwand 2x

Side wall 2x - Paroi latérale 2x - Zijwand 2x - panel lateral 2x - Parete laterale 2x - Sideplade 2x

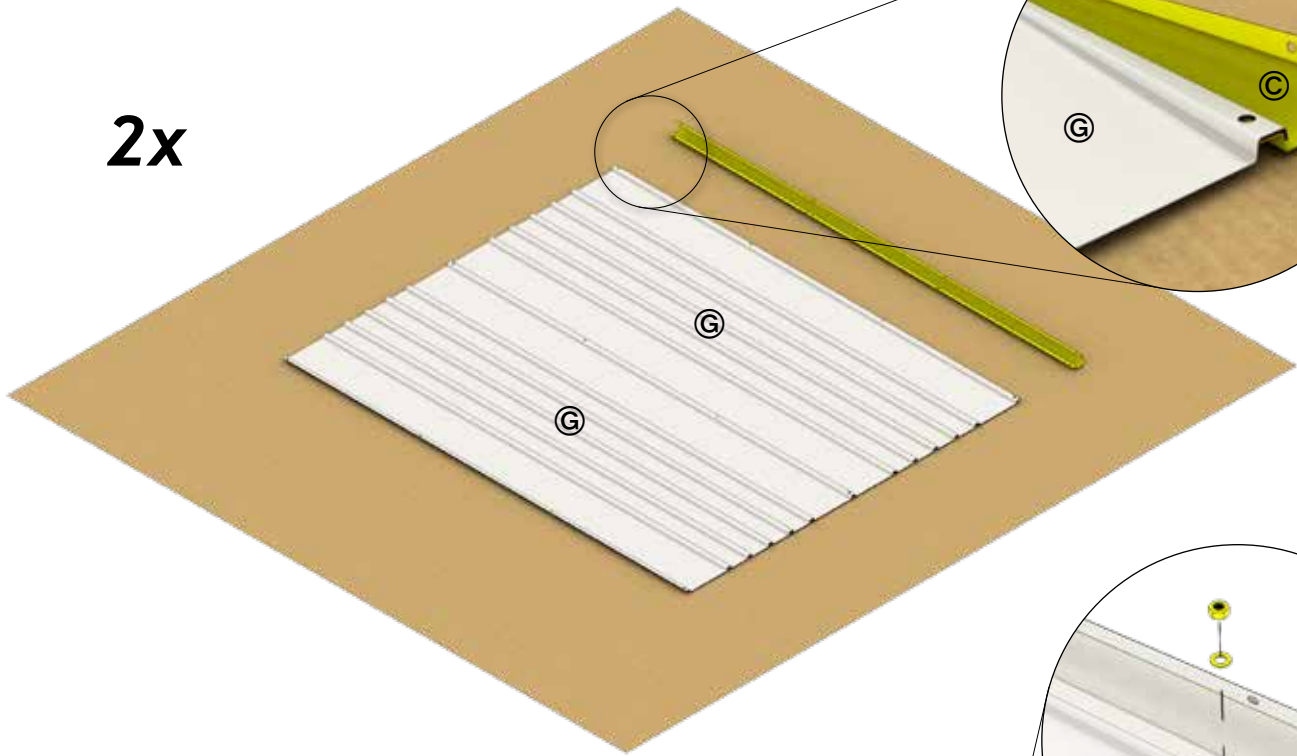

 2/2a ©	1: 2x	4A: 4x	 3 ©	1: 2x	4A: 2x	 M4 x 10 D2	1: 4x	4A: 8x
	2: 4x	5: 6x		2: 2x	5: 2x		2: 8x	5: 12x
	2A: 2x	6: 8x		2A: 2x	6: 2x		2A: 4x	6: 16x
	3: 4x	7: 8x		3: 2x	7: 2x		3: 8x	7: 16x
	4: 6x			4: 2x			4: 12x	

2x

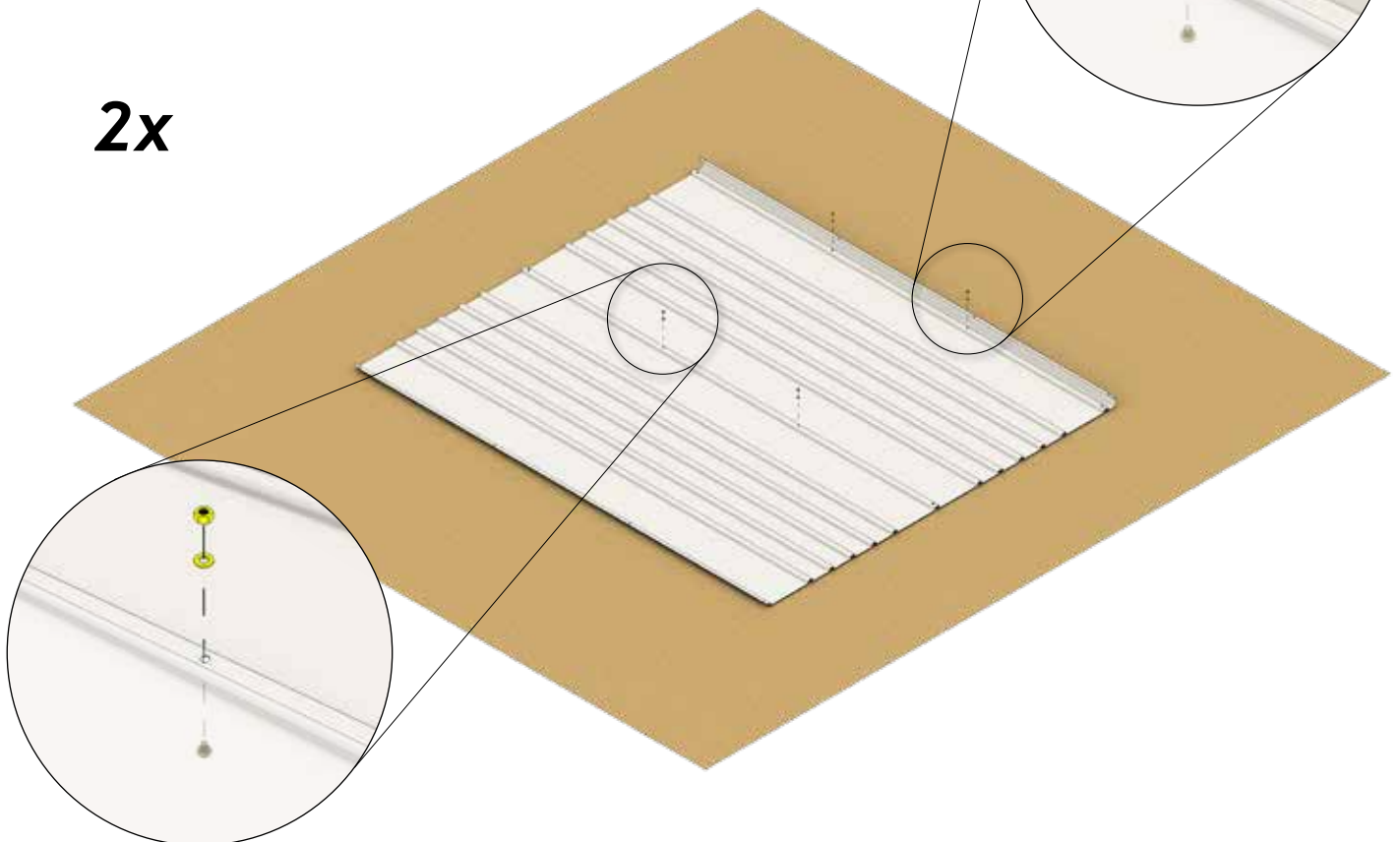

2x

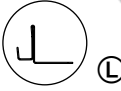

	<b>3</b>	1: 2x	4A: 2x		<b>3</b>	1: 2x	4A: 2x		M4 x 10	1: 4x	4A: 12x
		2: 2x	5: 2x			2: 2x	5: 2x		2: 8x	5: 12x	
		2A: 2x	6: 2x			2A: 2x	6: 2x		2A: 4x	6: 16x	
		3: 2x	7: 2x			3: 2x	7: 2x		3: 8x	7: 16x	
	4: 2x			4: 2x			4: 12x				

**2x**

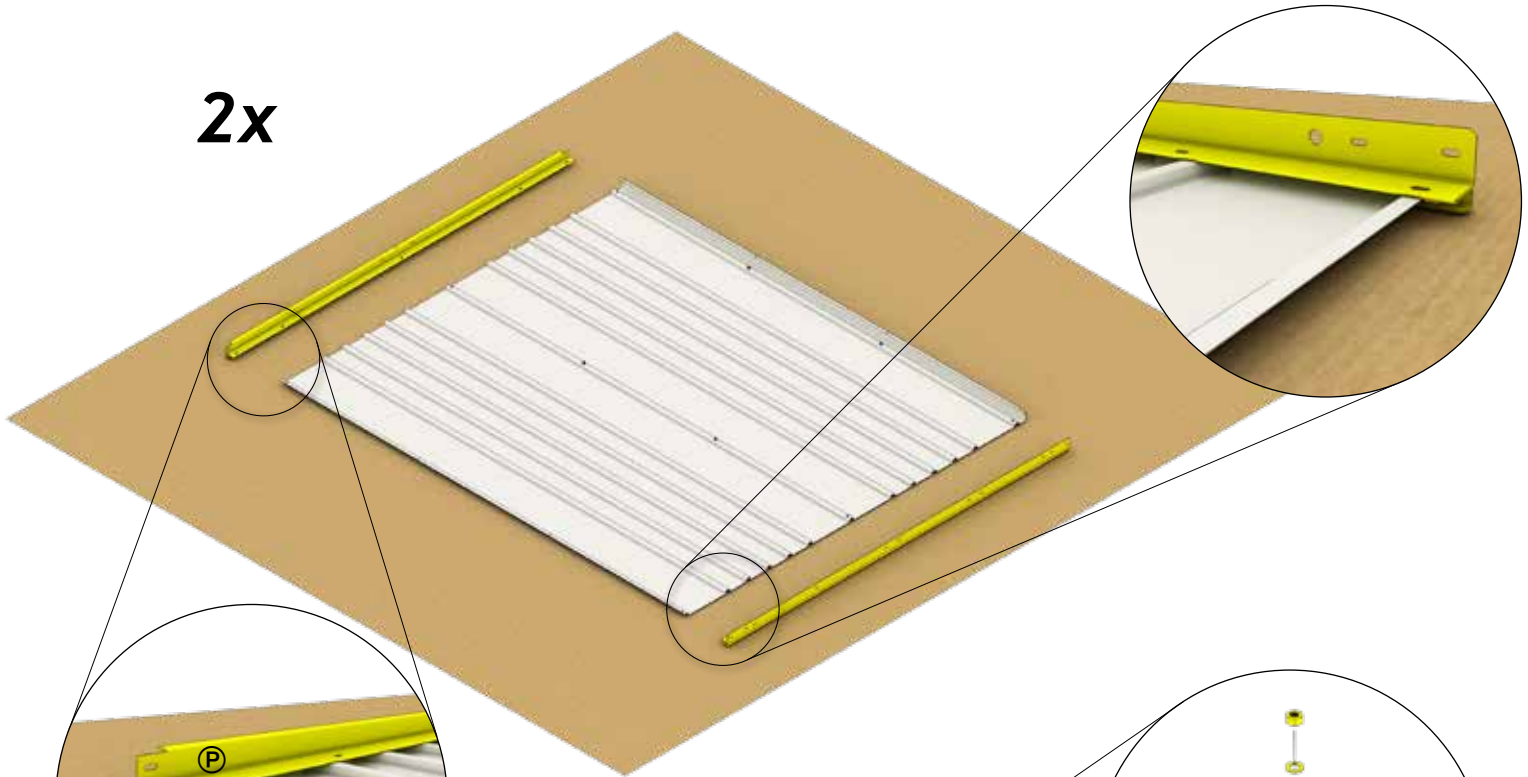

**2x**

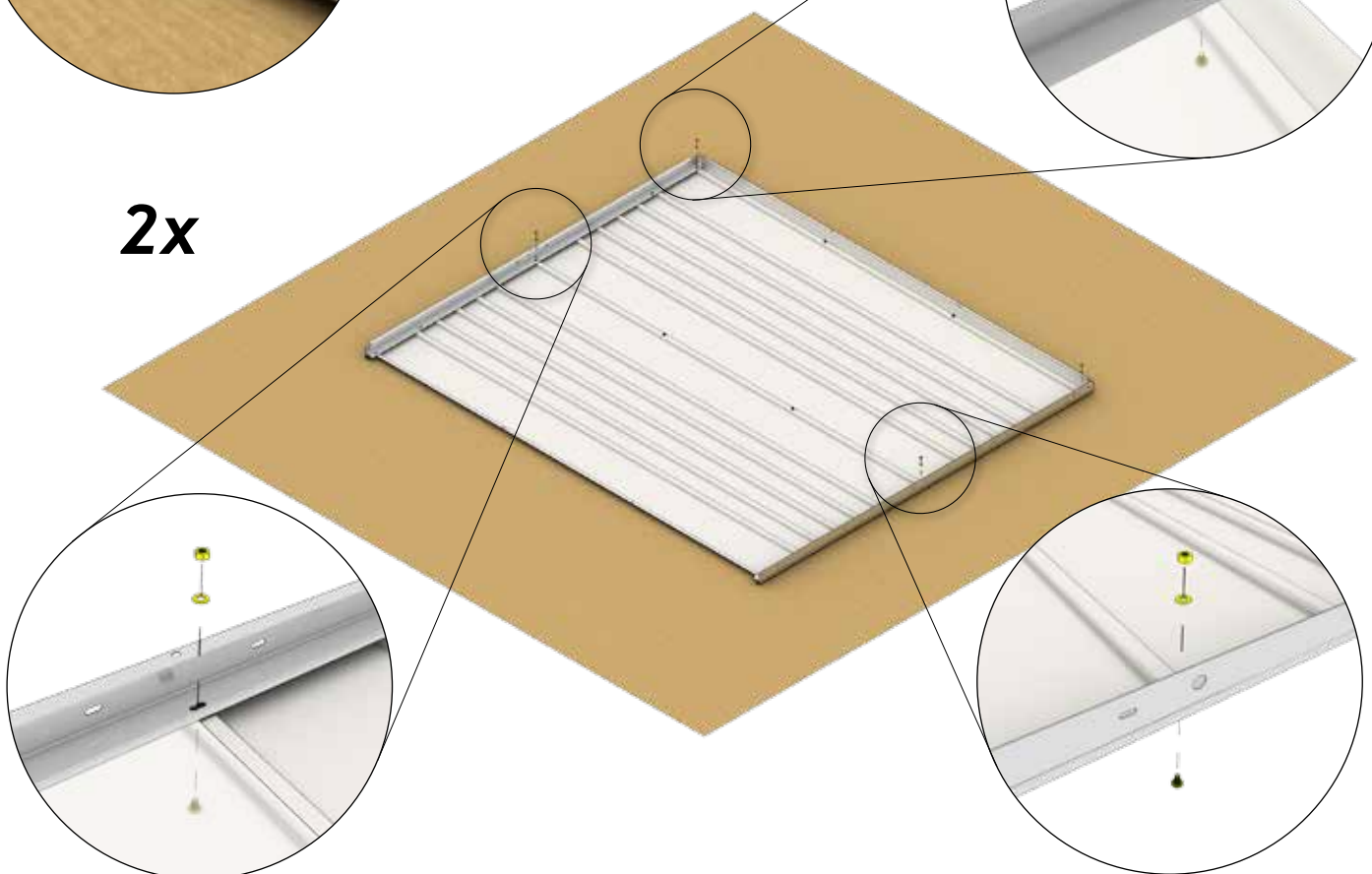



# Bodenrahmen

Floor Frame - Cadre de sol - Bodemframe - Marco de suelo - Telaio perimetrale - Bundramme

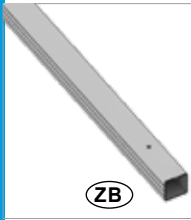

ZB

- |                 |                 |
|-----------------|-----------------|
| 1: 2x (700mm)   | 4A: 2x (1420mm) |
| 2: 4x (1420mm)  | 2x (1420mm)     |
| 2A: 2x (1420mm) | 5: 2x (2140mm)  |
| 2x (2140mm)     | 2x (2860mm)     |
| 3: 2x (1420mm)  | 6: 2x (2140mm)  |
| 2x (2140mm)     | 2x (2860mm)     |
| 4: 4x (2140mm)  | 7: 4x (2860mm)  |



ZC

- |        |        |
|--------|--------|
| 1: 4x  | 4A: 4x |
| 2: 4x  | 5: 4x  |
| 2A: 4x | 6: 4x  |
| 3: 4x  | 7: 4x  |
| 4: 4x  |        |

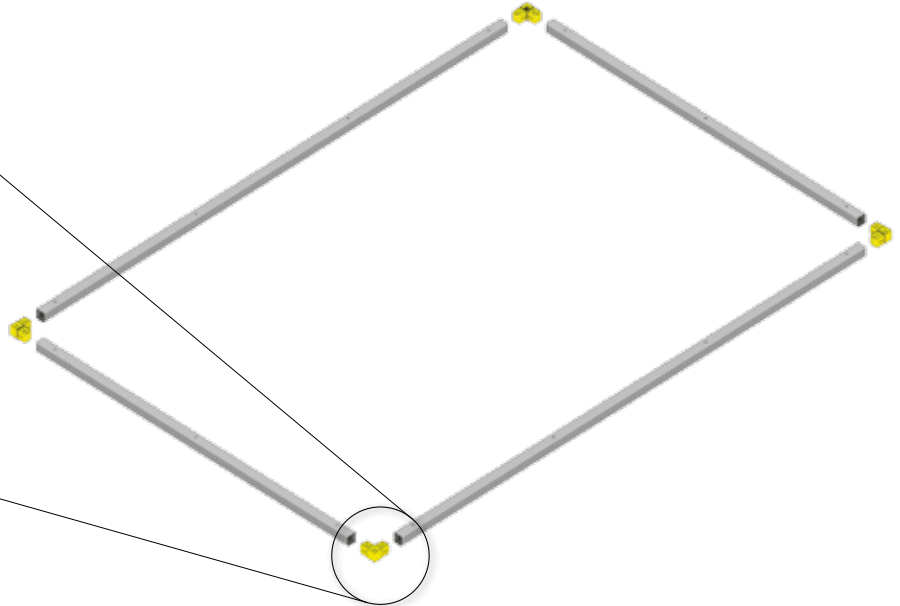

ZD

- |        |        |
|--------|--------|
| 1: 1x  | 4A: 1x |
| 2: 1x  | 5: 1x  |
| 2A: 1x | 6: 1x  |
| 3: 1x  | 7: 1x  |
| 4: 1x  |        |

6,3 x 22



ZF

- |        |        |
|--------|--------|
| 1: 1x  | 4A: 1x |
| 2: 1x  | 5: 1x  |
| 2A: 1x | 6: 1x  |
| 3: 1x  | 7: 1x  |
| 4: 1x  |        |

M4 x 10



D2

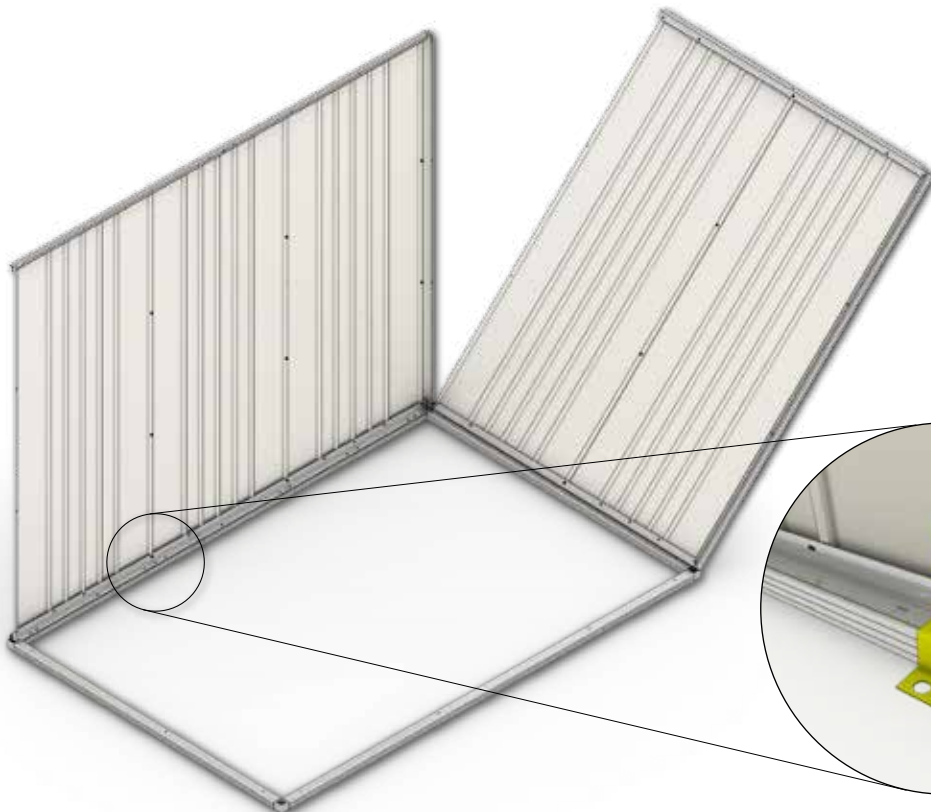

- |        |        |
|--------|--------|
| 1: 1x  | 4A: 1x |
| 2: 1x  | 5: 1x  |
| 2A: 1x | 6: 1x  |
| 3: 1x  | 7: 1x  |
| 4: 1x  |        |





# Bodenrahmen

Floor Frame - Cadre de sol - Bodemframe - Marco de suelo - Telaio perimetrale - Bundramme

 <p><b>ZD</b></p>	1: 4x	4A: 8x	 <p>M4 x 10</p> <p><b>D2</b></p>	1: 16x	4A: 16x	 <p>6,3 x 22</p> <p><b>ZF</b></p>	1: 15x	4A: 15x
	2: 6x	5: 10x		2: 16x	5: 16x		2: 15x	5: 15x
	2A: 6x	6: 10x		2A: 16x	6: 16x		2A: 15x	6: 15x
	3: 8x	7: 10x		3: 16x	7: 16x		3: 15x	7: 15x
	4: 8x			4: 16x			4: 15x	

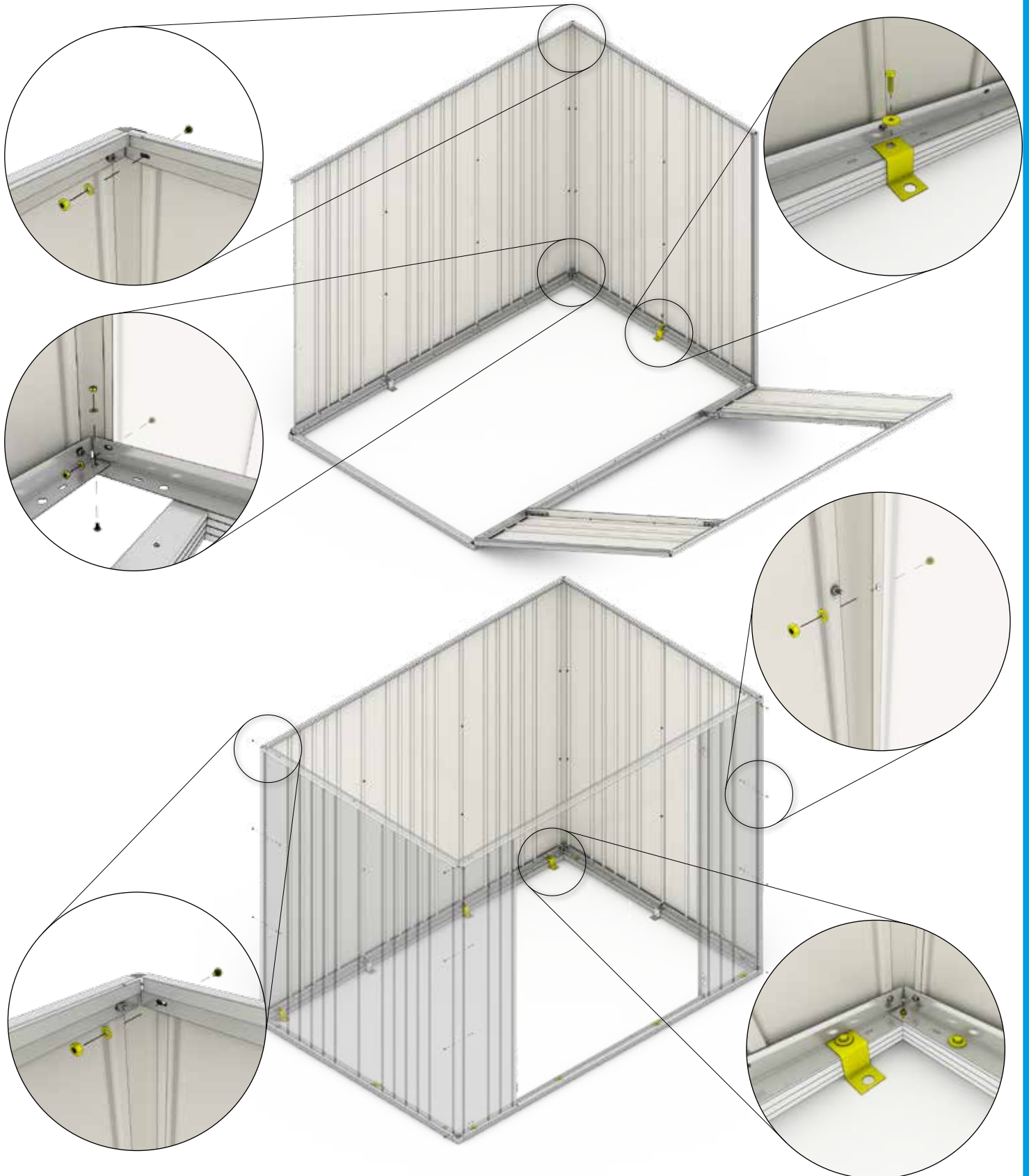

**4.****Nur für Größe 1 und 2**

Only for size 1 and 2 - Uniquement pour taille 1 et 2 - Alleen voor maat 1 en 2 - Sólo para los tamaños 1 y 2 - Solo per misura 1 e 2 - Kun for størrelse 1 og 2

M4 x 10		1: 10x
		2: 10x

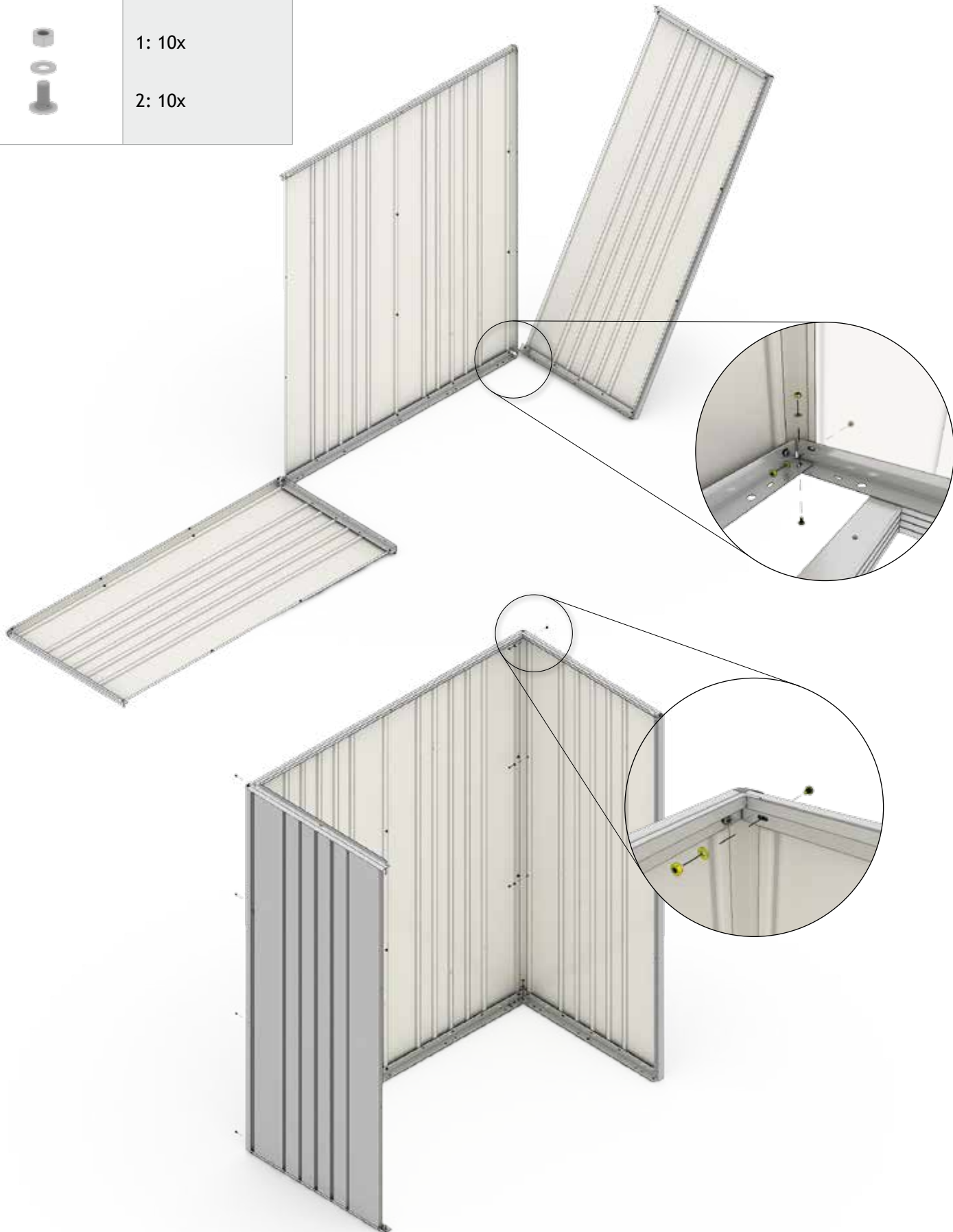





M4 x 10		1: 4x		1: 1x		1: 1x
		2: 4x		2: 1x		2: 1x

**1.**

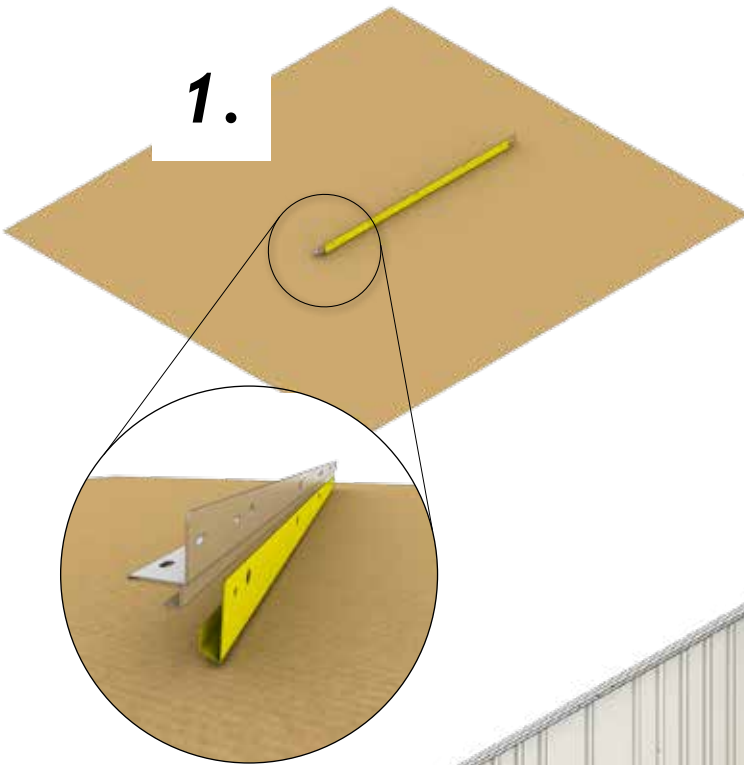

**2.**

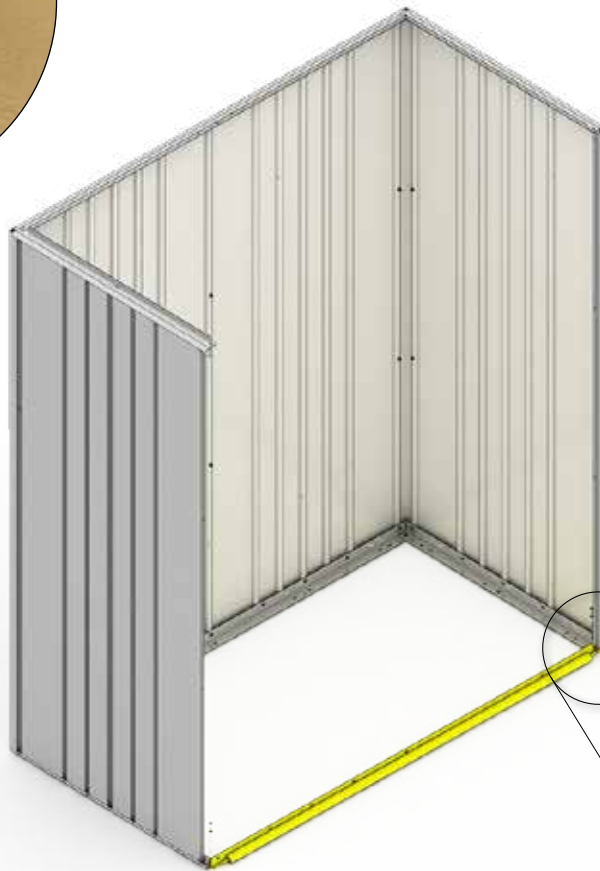
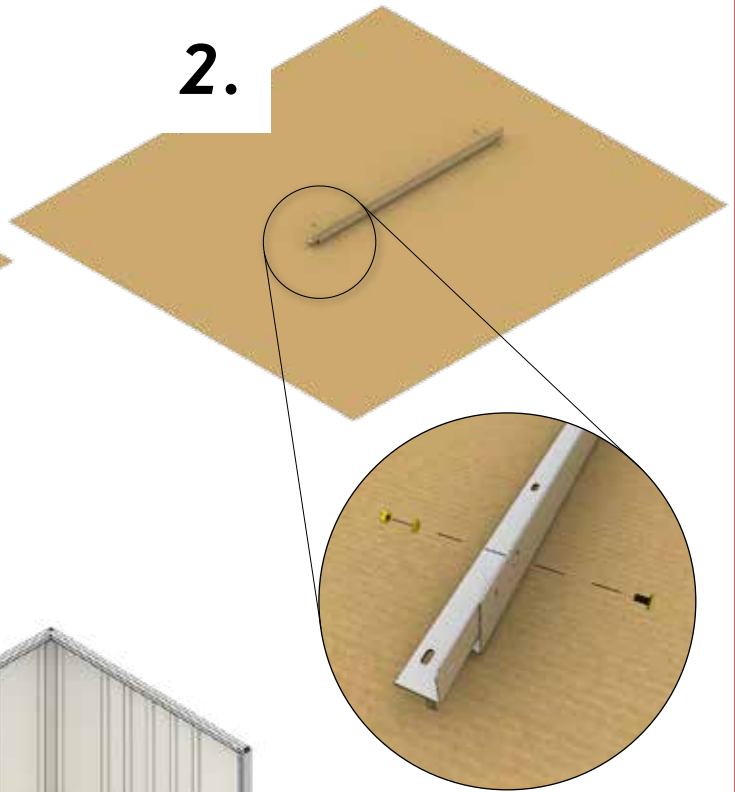

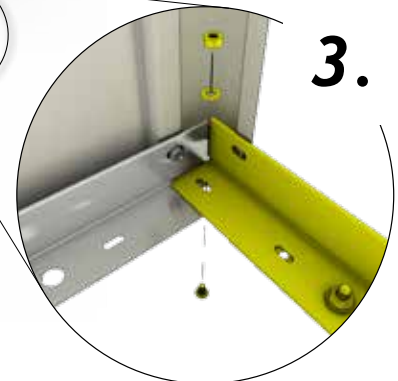

**3.**





### Nur für Größe 1 und 2

Only for size 1 and 2 - Uniquement pour taille 1 et 2- Alleen voor maat 1 en 2- Sólo para los tamaños 1 y 2 - Solo per misura 1 e 2 - Kun for størrelse 1 og 2

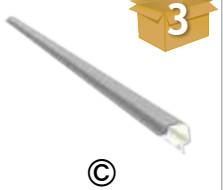
M4 x 10		1: 9x		1: 2x		1: 1x
		2: 9x		2: 2x		2: 1x

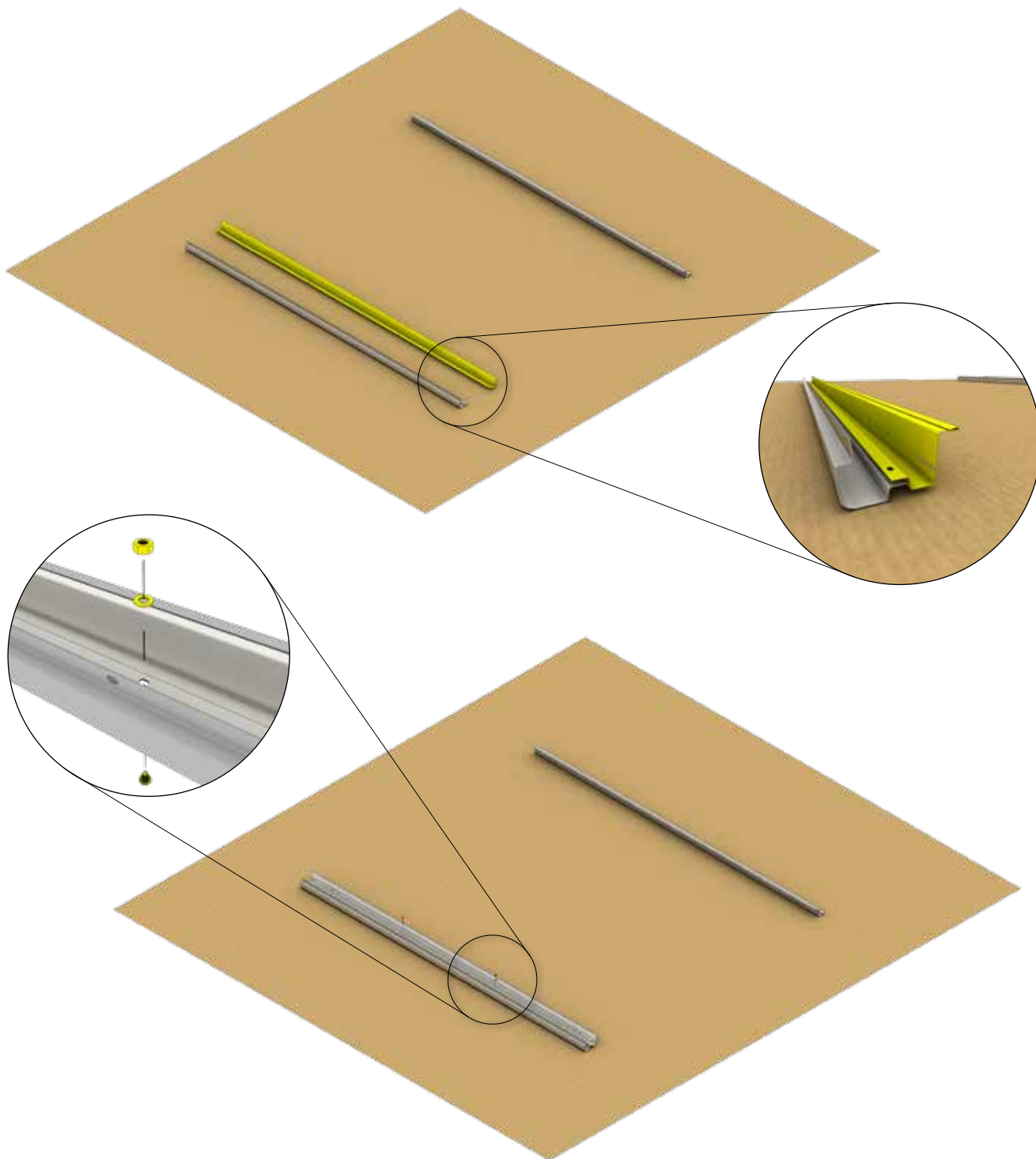

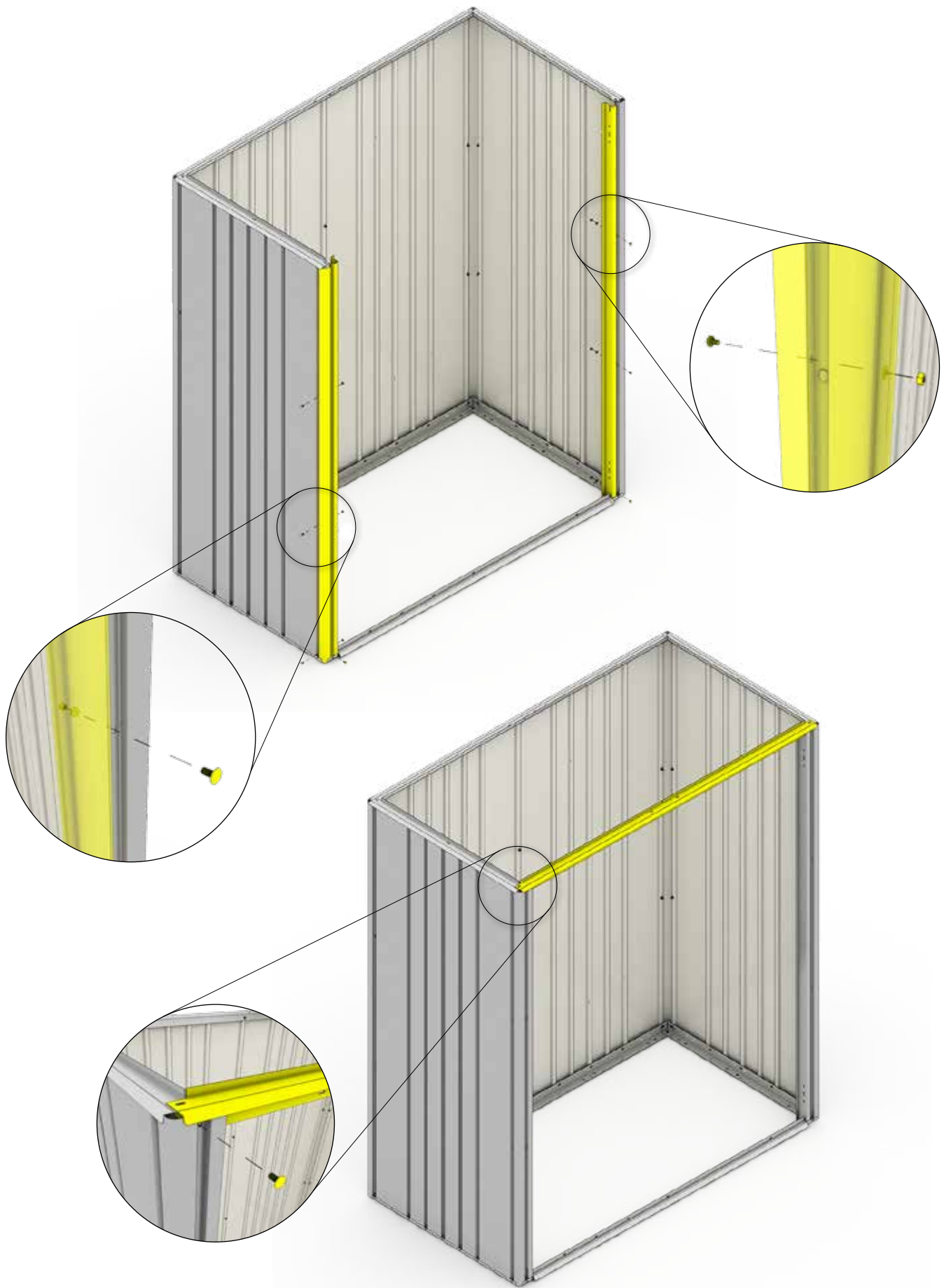







### Nur für Größe 1 und 2

Only for size 1 and 2 - Uniquement pour taille 1 et 2 - Alleen voor maat 1 en 2 - Sólo para los tamaños 1 y 2 - Solo per misura 1 e 2 - Kun for størrelse 1 og 2

 <b>(D1)</b>	1: 2x 2: 2x	 <b>(D1)</b>	1: 2x 2: 2x	 <b>(D1)</b>	1: 4x 2: 4x
M4 x 10 	1: 10x 2: 10x				

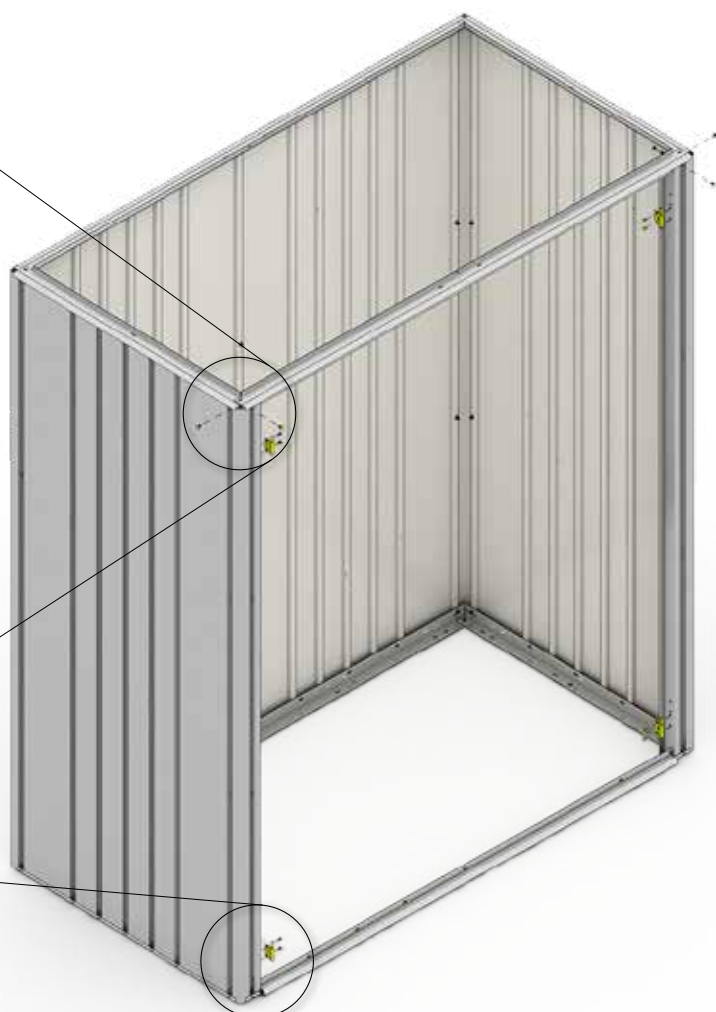
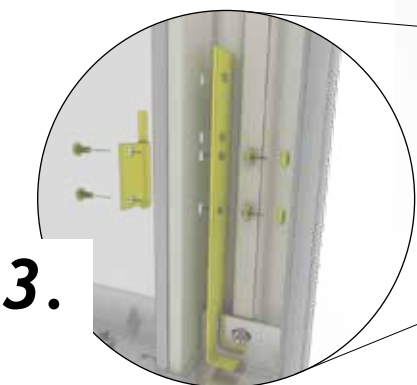
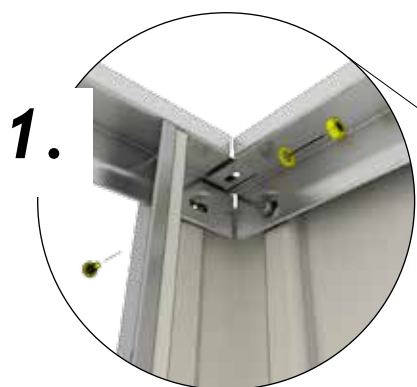

4.

M4 x 10



D2

2A: 20x	5: 20x
3: 20x	6: 20x
4: 20x	7: 20x
4A: 20x	



D1

2A: 2x	5: 2x
3: 2x	6: 2x
4: 2x	7: 2x
4A: 2x	



**Nur für Größe 2A-7!**

Only for size 2A-7  
 Uniquement pour taille 2A-7  
 Alleen voor maat 2A-7  
 Sólo para el tamaño 2A-7  
 Solo per misura 2A-7  
 Kun for størrelse 2A-7

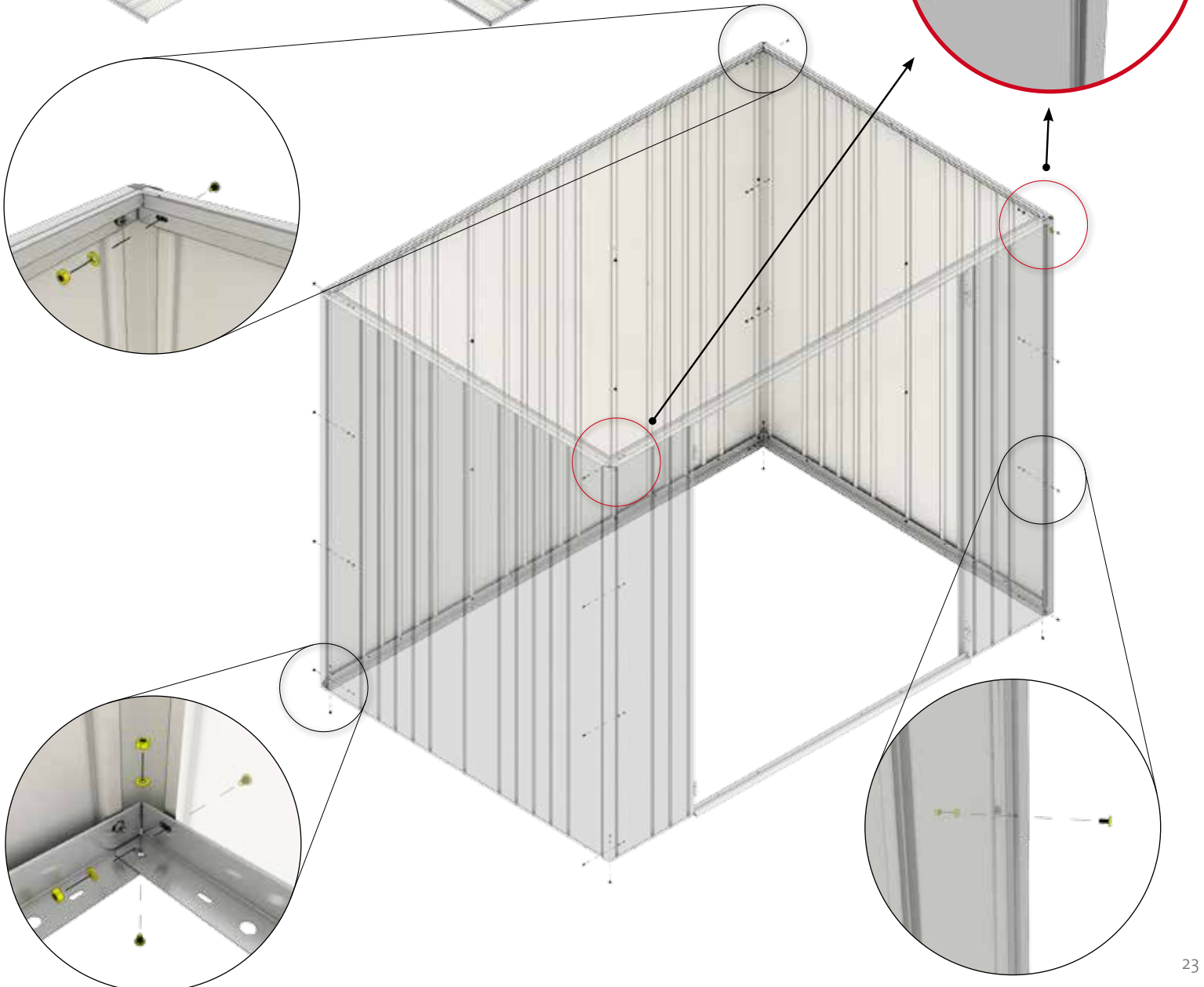







# 5.

Größenabhängiger Montageschritt - Size-Dependent assembly step - Dépendant de la taille - Size-Dependent montagestep

## Nur für Größe 5 und 7

Only for size 5 and 7 - Uniquement pour taille 5 et 7 - Alleen voor maat 5 en 7 - Sólo para los tamaños 5 y 7 - Solo per misura 5 e 7 - Kun for størrelse 5 og 7

 <b>H</b>	 5: 2x 7: 2x	 <b>H1</b>	5: 4x 7: 4x	M4 x 10  <b>D2</b>	5: 16x 7: 16x

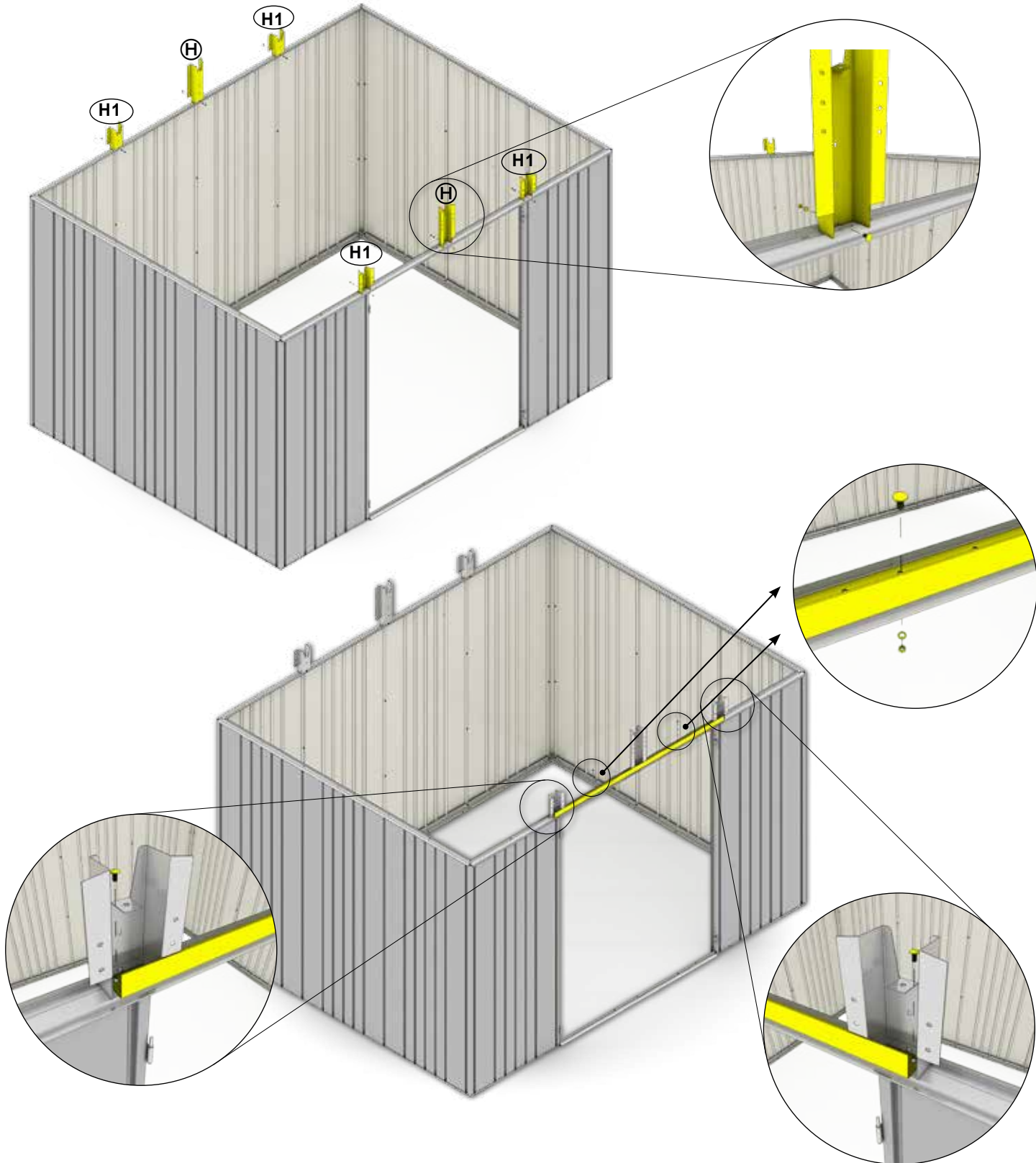

Paso de montaje de tamaño Dependiente - Taglia-Dependent fase di montaggio - Størrelses-anhængig montage skridt



## Nur für Größe 5 und 7

Only for size 5 and 7 - Uniquement pour taille 5 et 7 - Alleen voor maat 5 en 7 - Sólo para los tamaños 5 y 7 - Solo per misura 5 e 7 - Kun for størrelse 5 og 7

 <b>F</b>	5: 1x 7: 1x	 <b>J3</b>	5: 1x 7: 1x	 <b>J4</b>	5: 2x 7: 2x
M4 x 10  <b>D2</b>	5: 10x 7: 10x	 <b>I</b>	5: 4x 7: 4x		

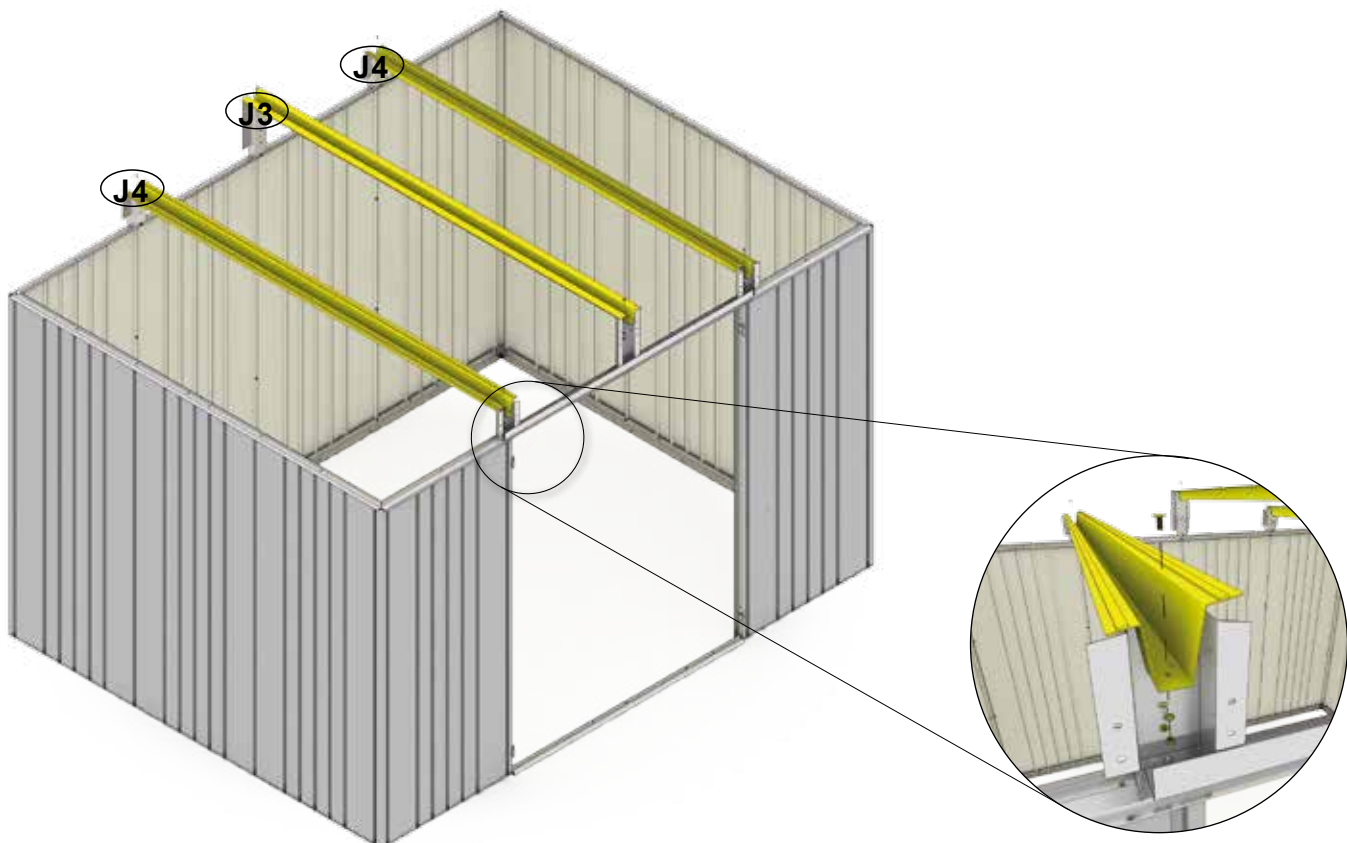
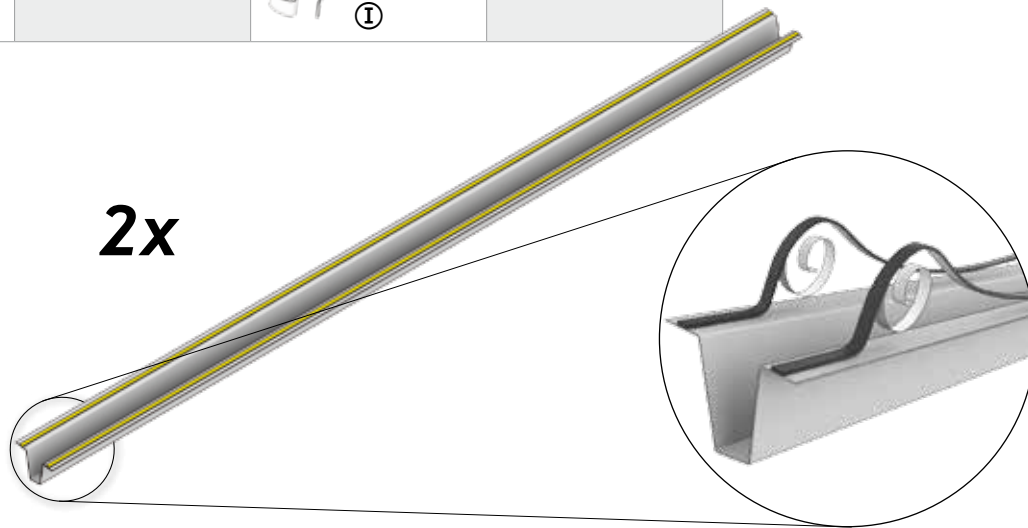

5.



- |        |        |
|--------|--------|
| 1: 2x  | 4A: 2x |
| 2: 2x  | 5: 2x  |
| 2A: 2x | 6: 2x  |
| 3: 2x  | 7: 2x  |
| 4: 2x  |        |

M4 x 10



- |        |        |
|--------|--------|
| 1: 2x  | 4A: 2x |
| 2: 2x  | 5: 2x  |
| 2A: 2x | 6: 2x  |
| 3: 2x  | 7: 2x  |
| 4: 2x  |        |

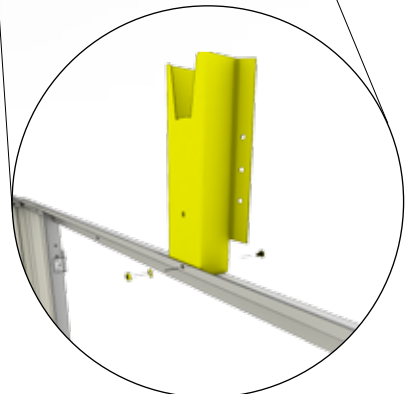
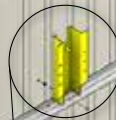
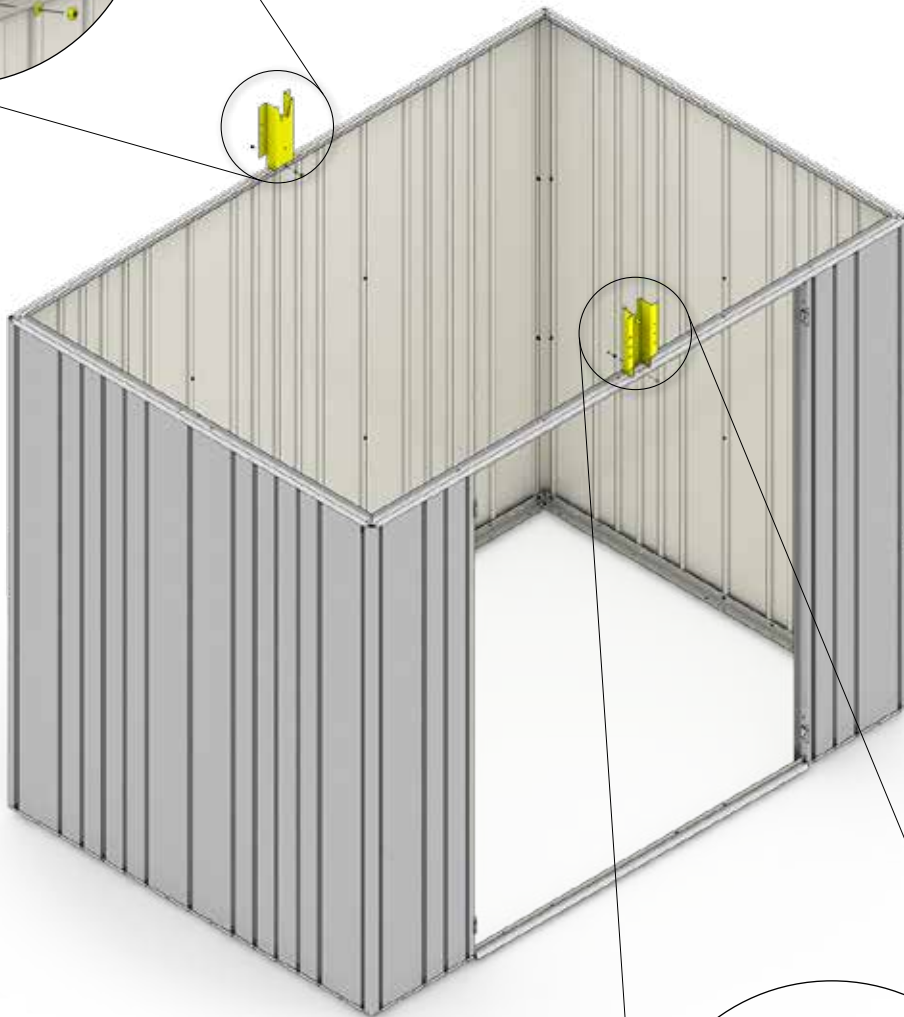
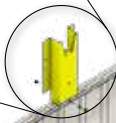
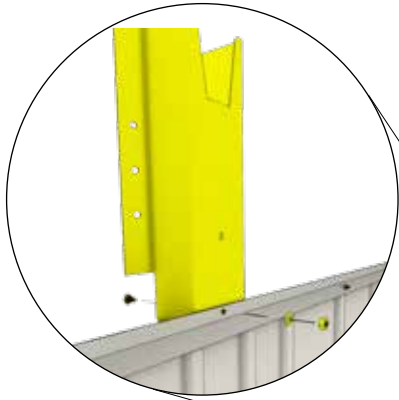

6.



- 1: 1x 4A: 1x
- 2: 1x 5: 1x
- 2A: 1x 6: 1x
- 3: 1x 7: 1x
- 4: 1x

Ⓕ



- 1: 1x 4A: 1x
- 2: 1x 5: 1x
- 2A: 1x 6: 1x
- 3: 1x 7: 1x
- 4: 1x



J3

M4 x 10





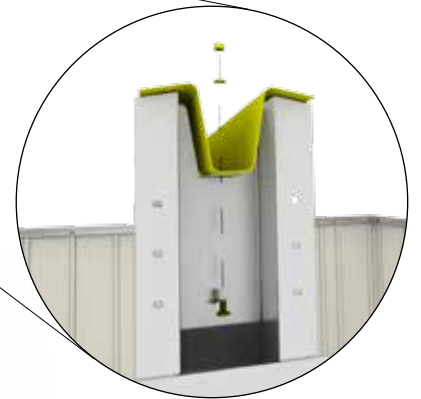
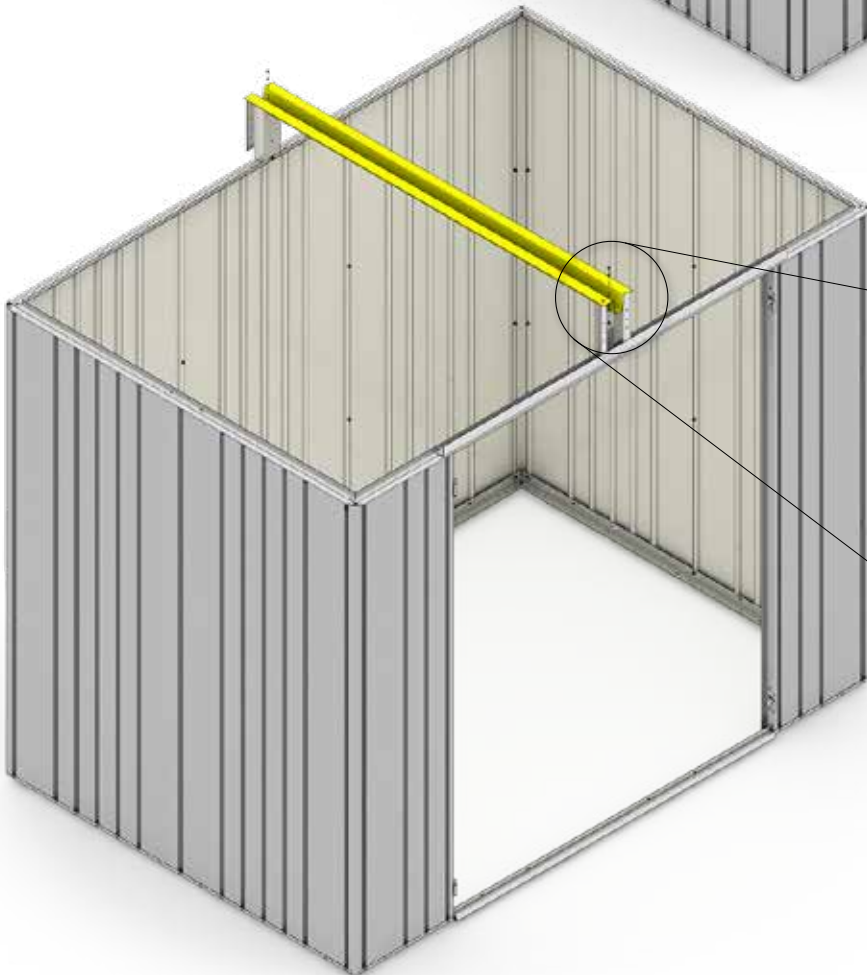
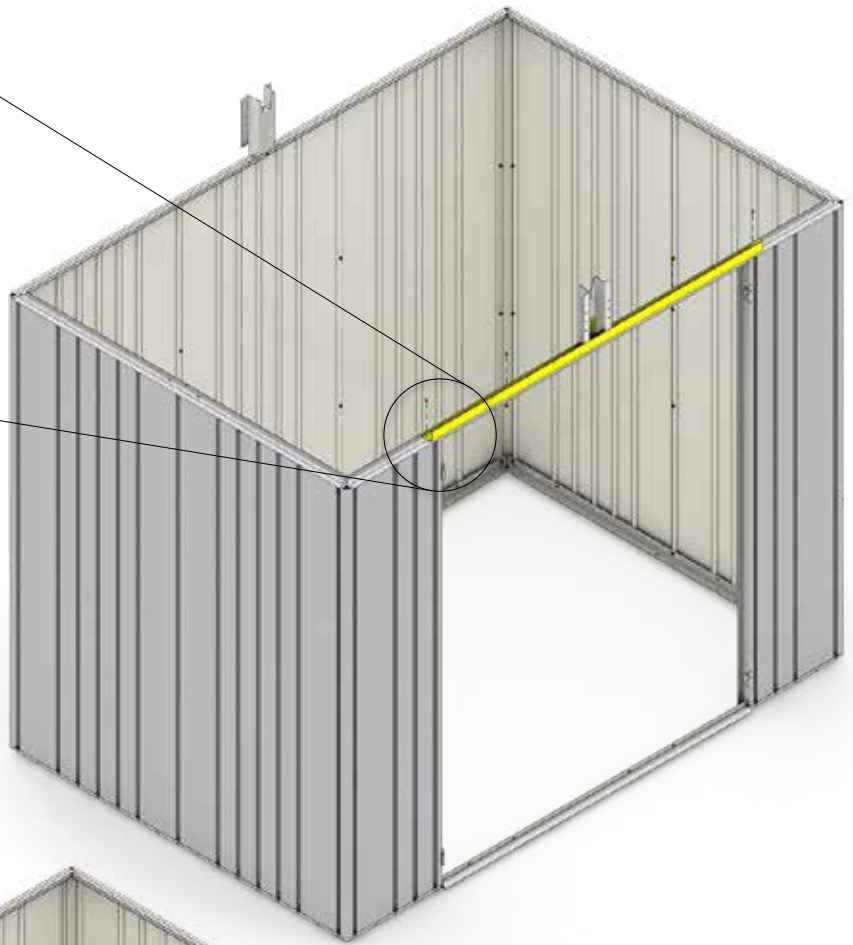
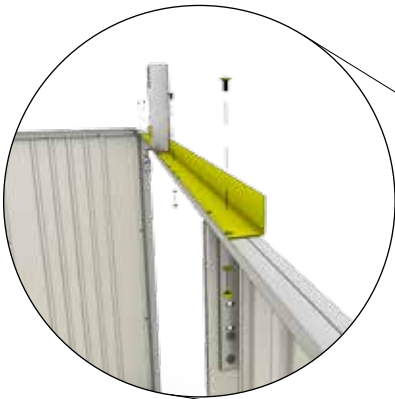

Ⓓ2

- 1: 10x 4A: 10x
- 2: 4x 5: 10x
- 2A: 6x 6: 10x
- 3: 6x 7: 10x
- 4: 6x



7.

 (AM)	 3	1: 2x 2: 2x 2A: 2x 3: 2x 4: 2x	4A: 2x 5: 2x 6: 2x 7: 2x	 (AN)	 3	1: 2x 2: 2x 2A: 2x 3: 2x 4: 2x	4A: 2x 5: 2x 6: 2x 7: 2x	M4 x 10  (D2)	1: 8x 2: 8x 2A: 8x 3: 8x 4: 8x	4A: 8x 5: 8x 6: 8x 7: 8x
---	--	--	-----------------------------------	---	--	--	-----------------------------------	--	--	-----------------------------------

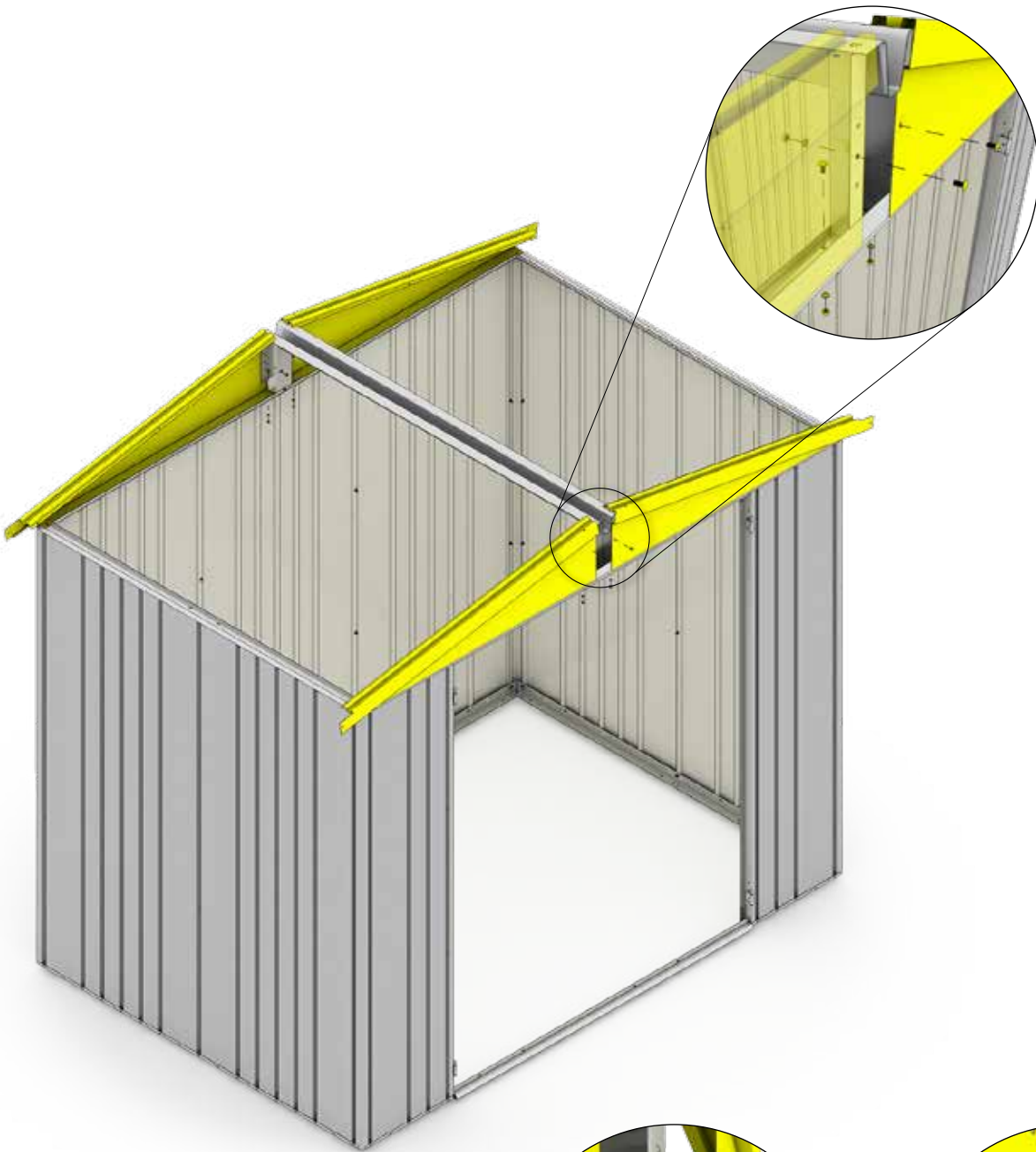



8.



- |        |        |
|--------|--------|
| 1: 2x  | 4A: 2x |
| 2: 2x  | 5: 2x  |
| 2A: 2x | 6: 2x  |
| 3: 2x  | 7: 2x  |
| 4: 2x  |        |

M4 x 10



- |        |        |
|--------|--------|
| 1: 6x  | 4A: 8x |
| 2: 8x  | 5: 10x |
| 2A: 6x | 6: 12x |
| 3: 8x  | 7: 12x |
| 4: 10x |        |

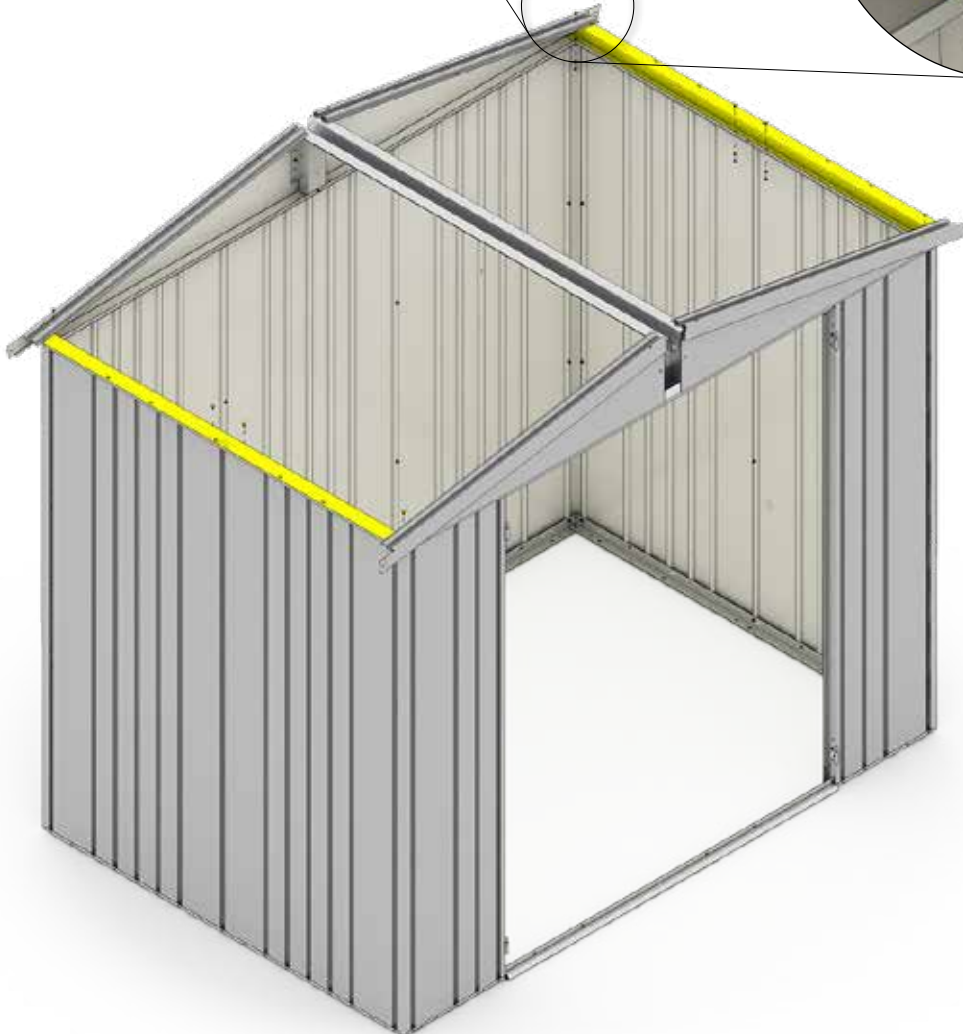
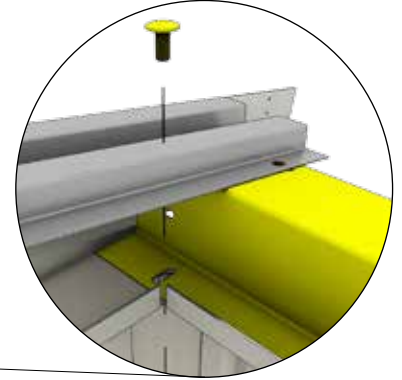
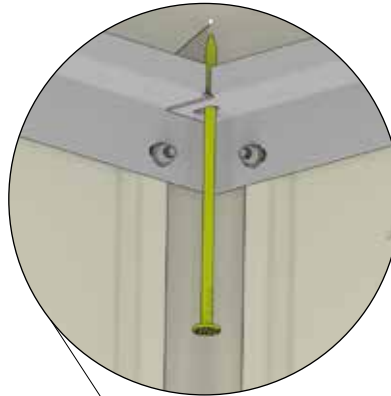

optionales Zubehör - Accessories - Accessoires - Toebehoor - Accessori - Accesorios - Ekstraudstyr





Seitendach | side canopy | auvent

Aufbauanleitung für Seitendach beachten. Muss nur ausgeführt werden, wenn Sie das Zubehör auch bestellt haben.

(GB) Notice assembly manual for side canopy. Only necessary if you have ordered it as accessory.

(F) Instruction de montage pour auvent à suivre. A ne réaliser uniquement si vous avez commandé cet accessoire.

# 9.

 <p>②</p>		1: 2x	4A: 2x	 <p>M4 x 10</p> <p>ⓓ2</p>	1: 4x	4A: 4x	 <p>ⓓ1</p>	1: 2x
	2: 2x	5: 2x	2: 4x		5: 4x	2: 2x		
	2A: 2x	6: 2x	2A: 4x		6: 4x			
	3: 2x	7: 2x	3: 4x		7: 4x			
4: 2x		4: 4x					2: 2x	

## 1.



## 2.

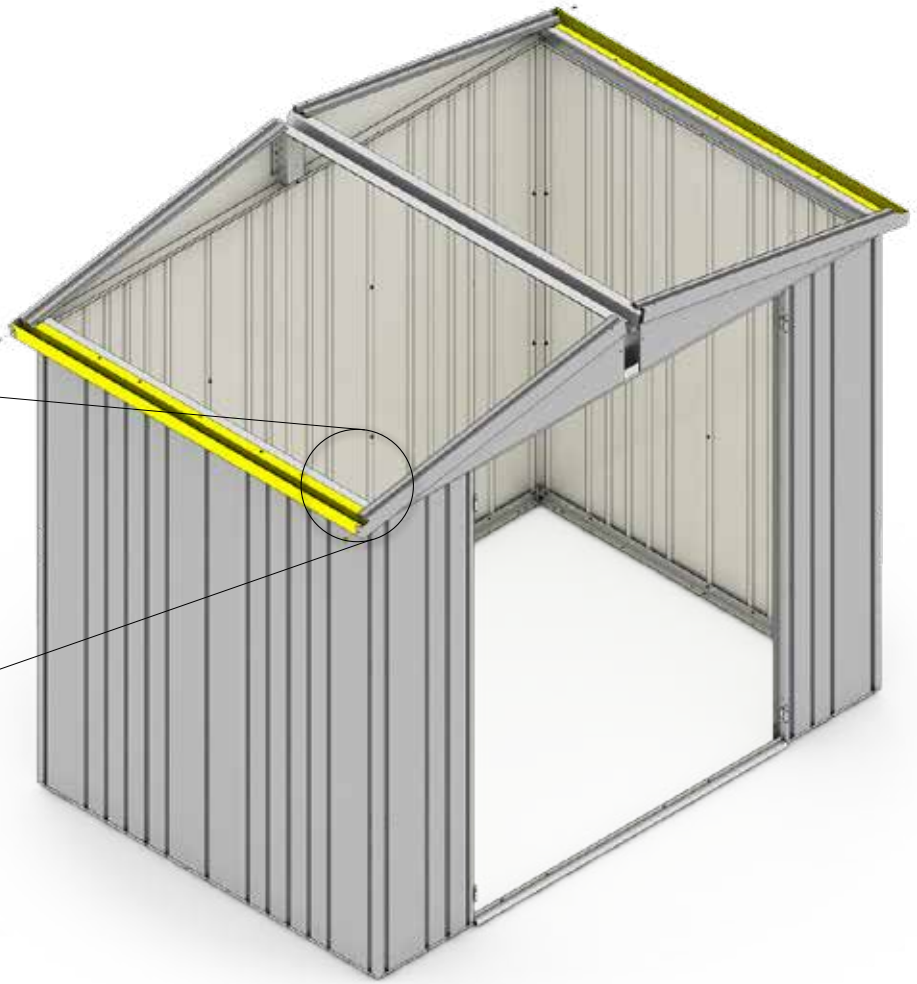
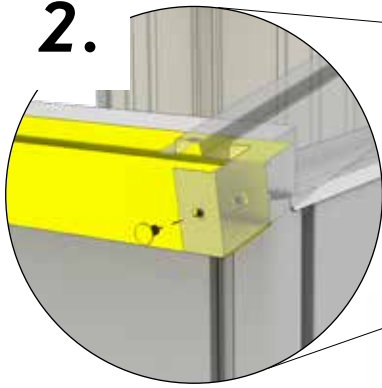

**Nur für Größe 1-2!**  
 Only for size 1-2  
 Uniquement pour taille 1-2  
 Alleen voor maat 1-2  
 Sólo para el tamaño 1-2  
 Solo per misura 1-2  
 Kun for størrelse 1-2

10.

2

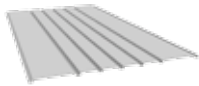

Y

- |        |        |
|--------|--------|
| 1: 2x  | 4A: 4x |
| 2: 4x  | 5: 8x  |
| 2A: 2x | 6: 6x  |
| 3: 4x  | 7: 8x  |
| 4: 6x  |        |

M4 x 10



D2



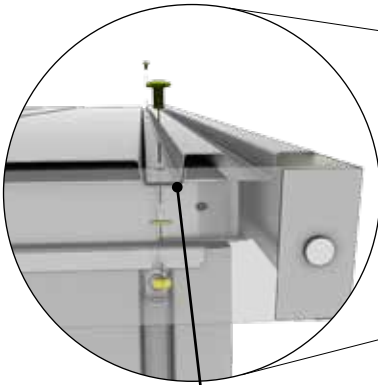
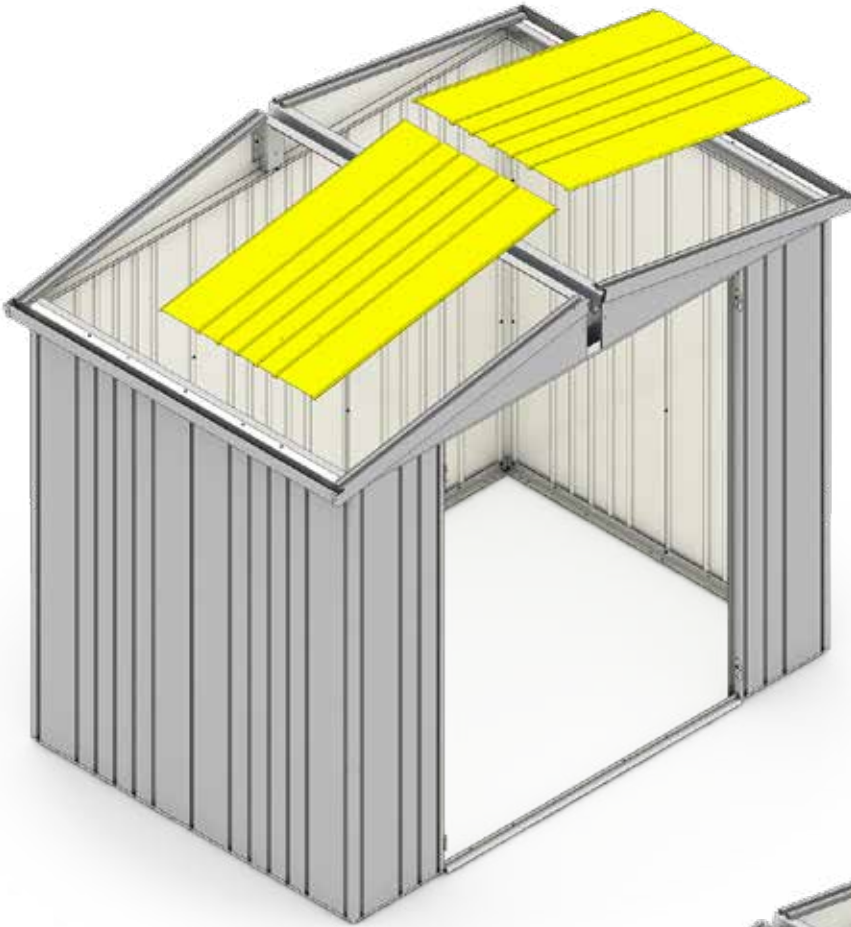

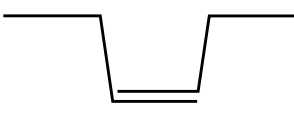
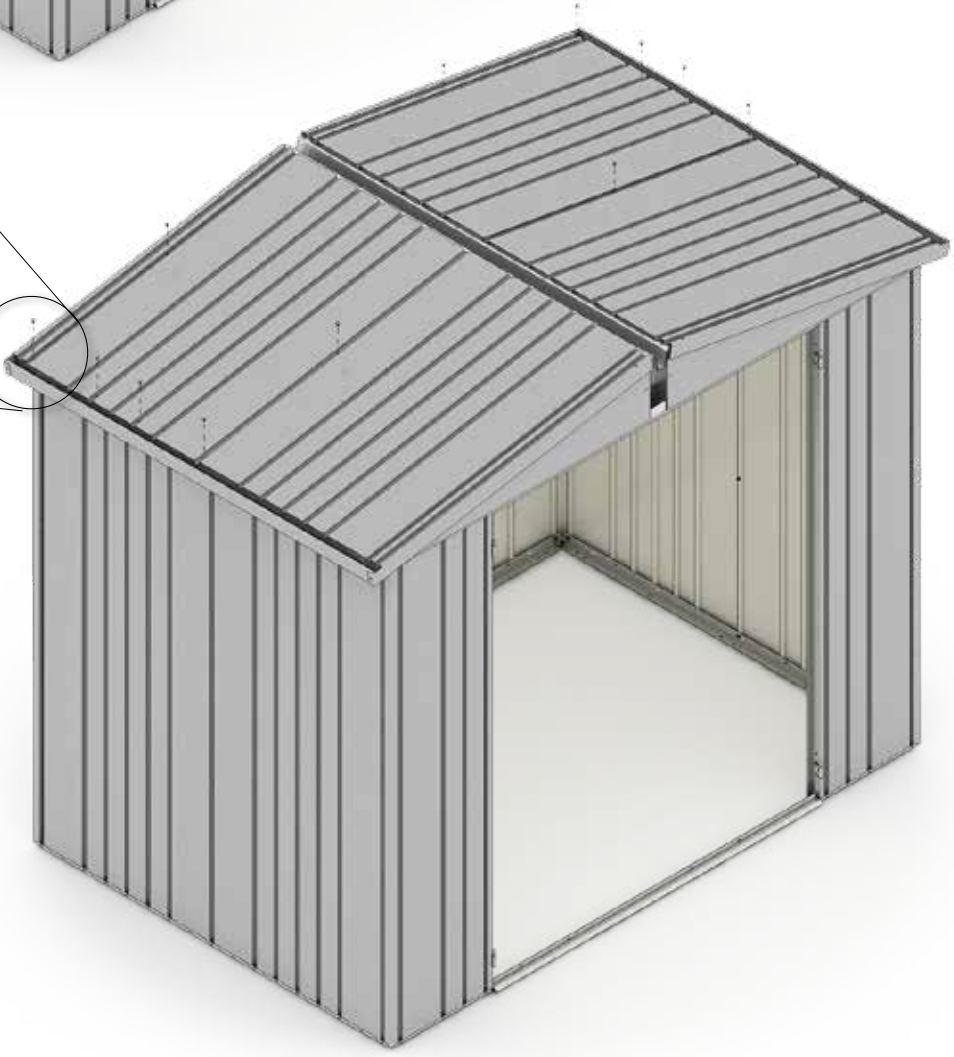
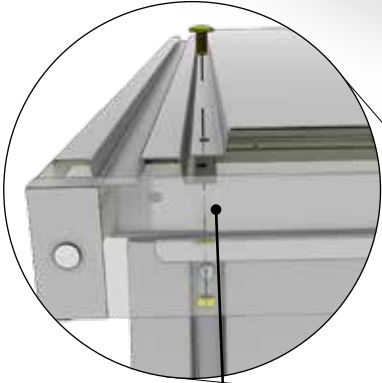
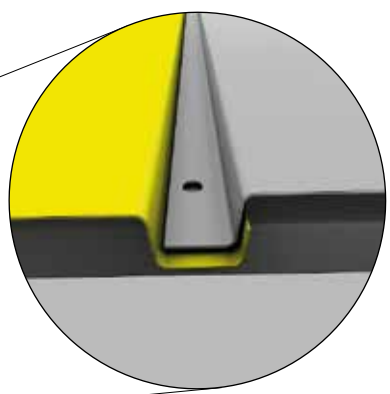
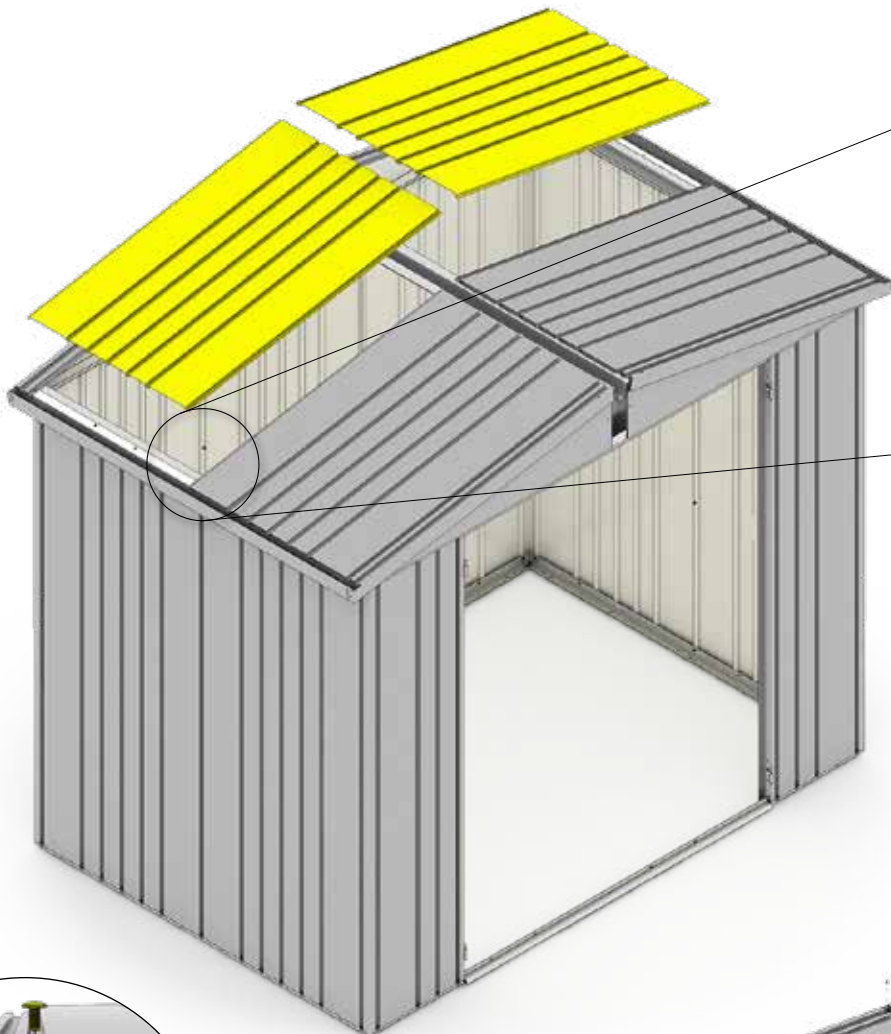
- |         |         |
|---------|---------|
| 1: 8x   | 4A: 26x |
| 2: 14x  | 5: 32x  |
| 2A: 12x | 6: 32x  |
| 3: 20x  | 7: 46x  |
| 4: 28x  |         |





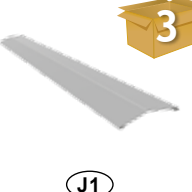

11.

		1: 1x	4A: 1x			1: 1x	4A: 1x		2: 1x	5: 2x
		2: 1x	5: 1x			2: 1x	5: 1x		3: 1x	6: 3x
		2A: 1x	6: 1x			2A: 1x	6: 1x		3: 1x	7: 3x
		3: 1x	7: 1x			3: 1x	7: 1x		4: 2x	7: 3x
		4: 1x				4: 1x			4A: 1x	

1.

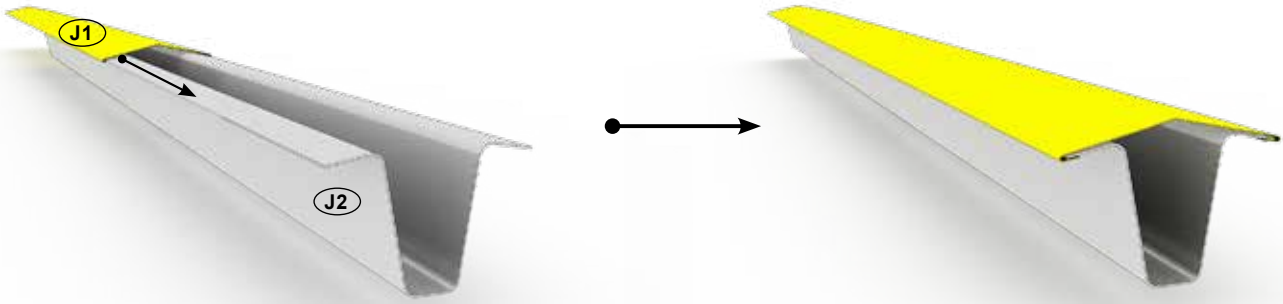

2.

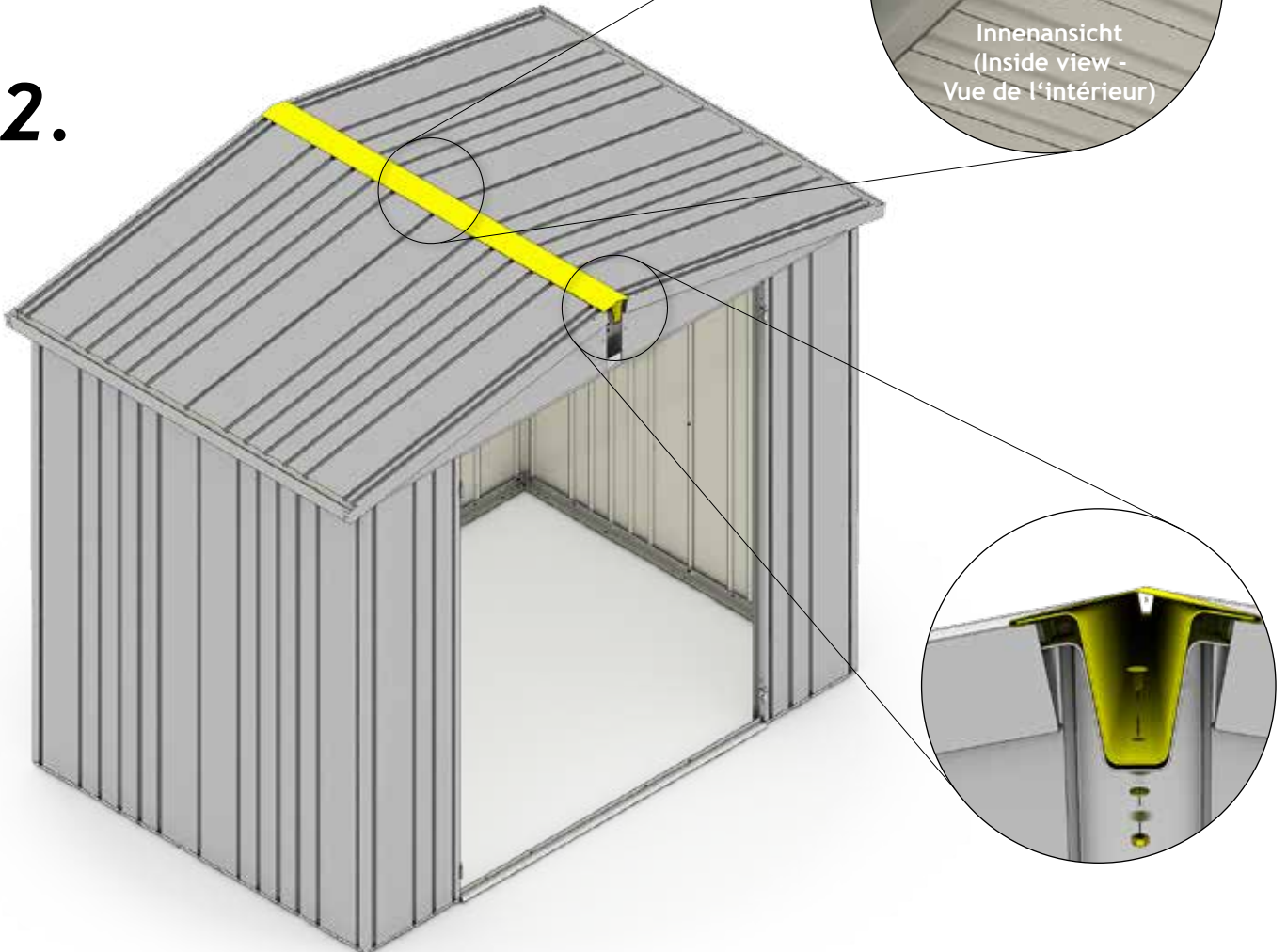

12.

3



AS

- |        |        |
|--------|--------|
| 1: 2x  | 4A: 2x |
| 2: 2x  | 5: 2x  |
| 2A: 2x | 6: 2x  |
| 3: 2x  | 7: 2x  |
| 4: 2x  |        |

M4 x 10



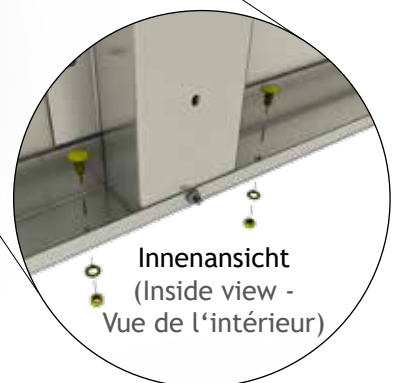
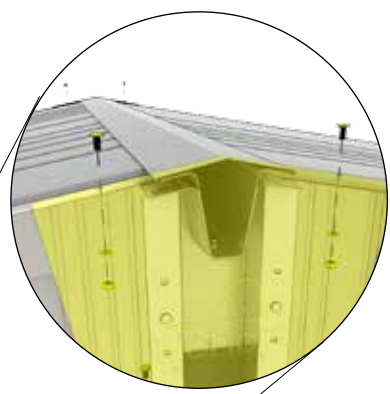
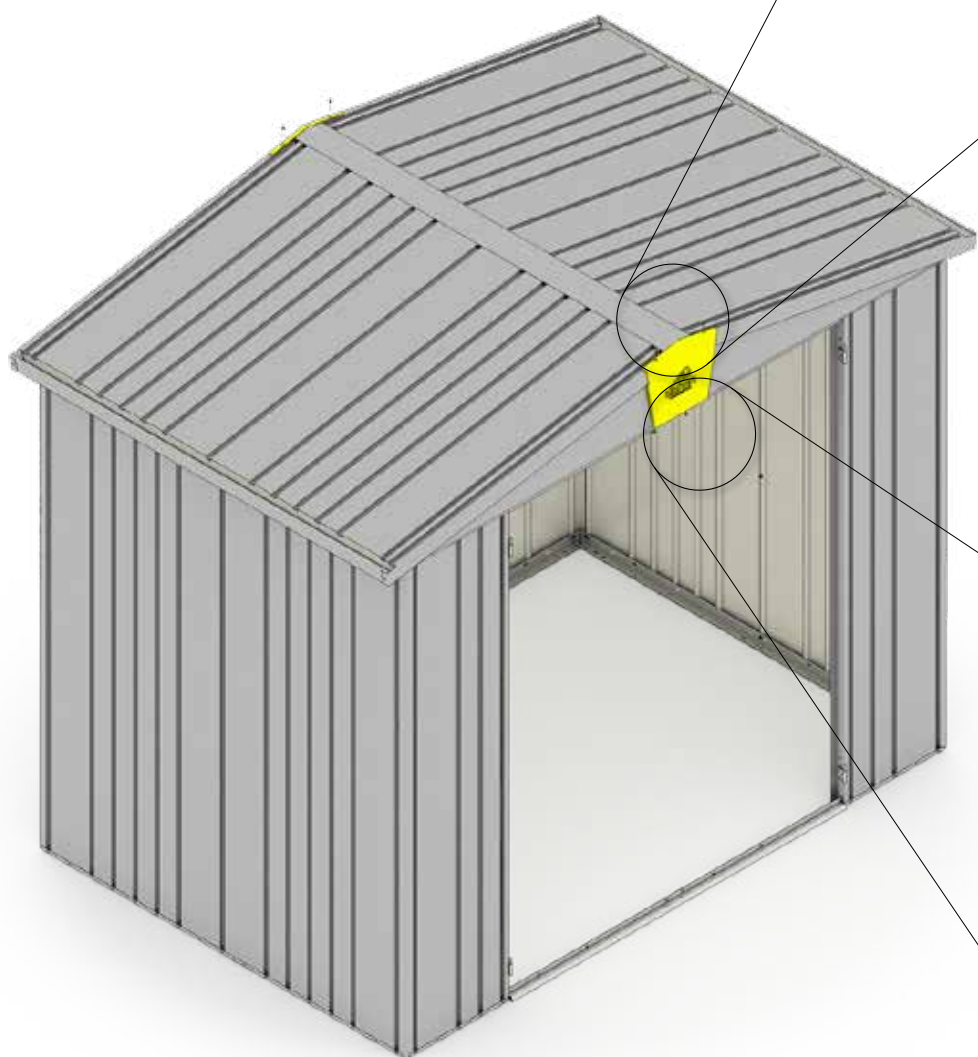

D2

- |        |        |
|--------|--------|
| 1: 8x  | 4A: 8x |
| 2: 8x  | 5: 8x  |
| 2A: 8x | 6: 8x  |
| 3: 8x  | 7: 8x  |
| 4: 8x  |        |



Innenansicht  
(Inside view -  
Vue de l'intérieur)

13.

	1: 2x	4A: 2x		1: 2x	4A: 2x
	2: 2x	5: 2x		2: 2x	5: 2x
	2A: 2x	6: 2x		2A: 2x	6: 2x
	3: 2x	7: 2x		3: 2x	7: 2x
	4: 2x			4: 2x	

1.





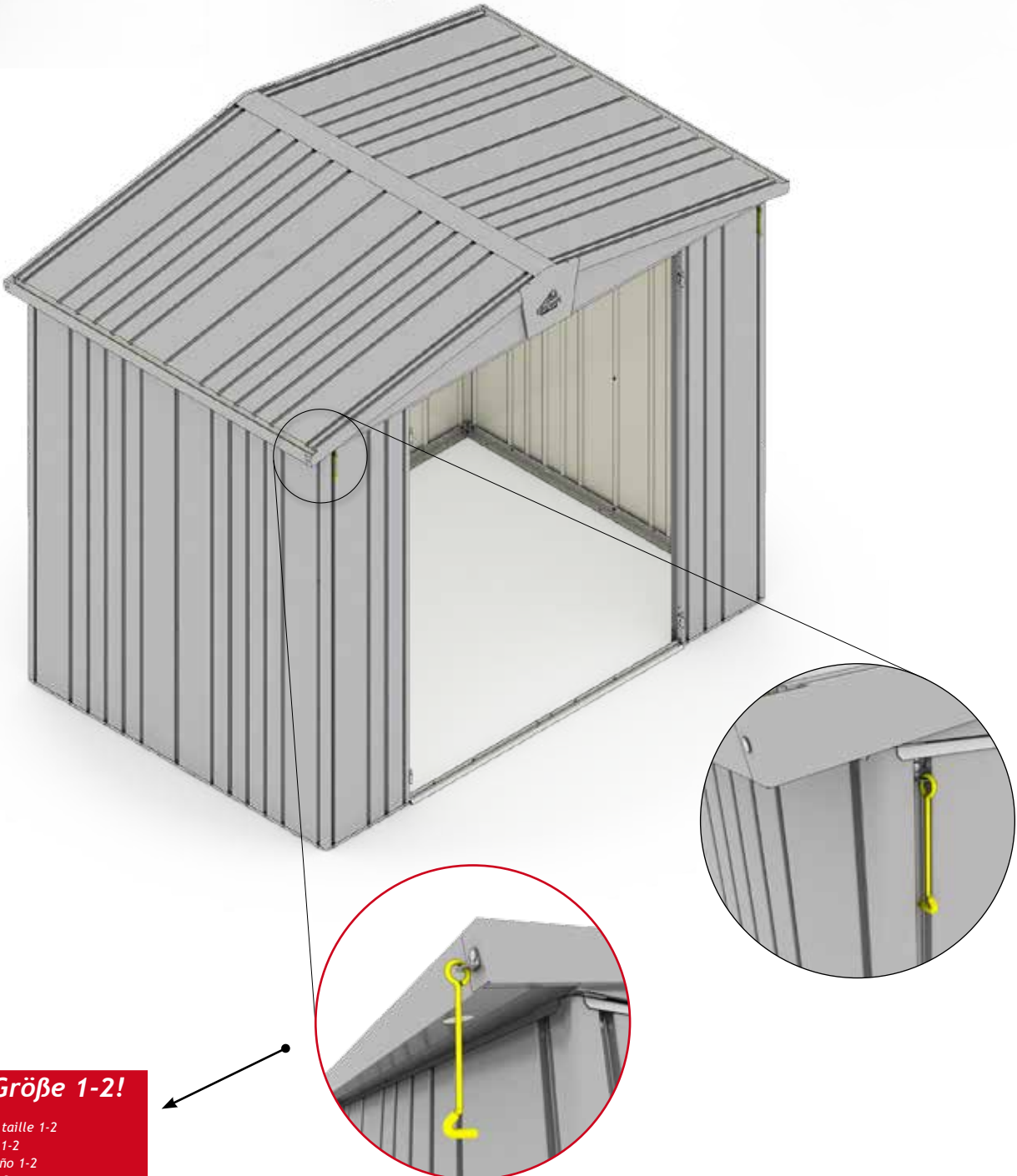



2.



**Nur für Größe 1-2!**  
 Only for size 1-2  
 Uniquement pour taille 1-2  
 Alleen voor maat 1-2  
 Sólo para el tamaño 1-2  
 Solo per misura 1-2  
 Kun for størrelse 1-2



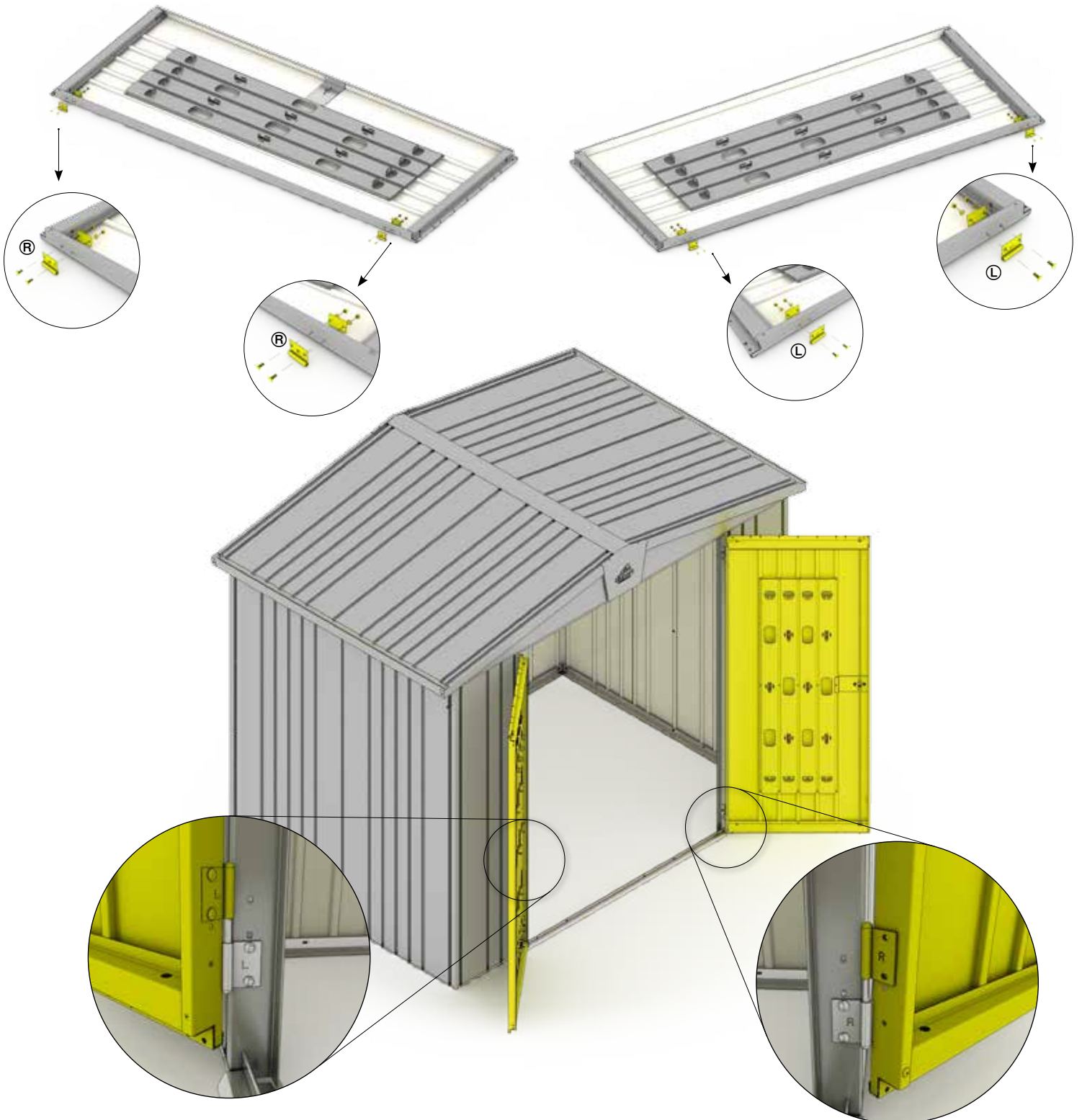

# 14.

 <p><b>(D1)</b></p>	<p>1: 2x 4A: 2x 2: 2x 5: 2x 2A: 2x 6: 2x 3: 2x 7: 2x 4: 2x</p>	 <p><b>(D1)</b></p>	<p>1: 2x 4A: 2x 2: 2x 5: 2x 2A: 2x 6: 2x 3: 2x 7: 2x 4: 2x</p>	 <p><b>(D1)</b></p>	<p>1: 4x 4A: 4x 2: 4x 5: 4x 2A: 4x 6: 4x 3: 4x 7: 4x 4: 4x</p>
 <p><b>(B)</b></p>	<p>1: 1x 4A: 1x 2: 1x 5: 1x 2A: 1x 6: 1x 3: 1x 7: 1x 4: 1x</p>	 <p><b>(ZA)</b></p>	<p>M4 x 10</p>  <p><b>(D2)</b></p>	<p>1: 8x 4A: 8x 2: 8x 5: 8x 2A: 8x 6: 8x 3: 8x 7: 8x 4: 8x</p>	





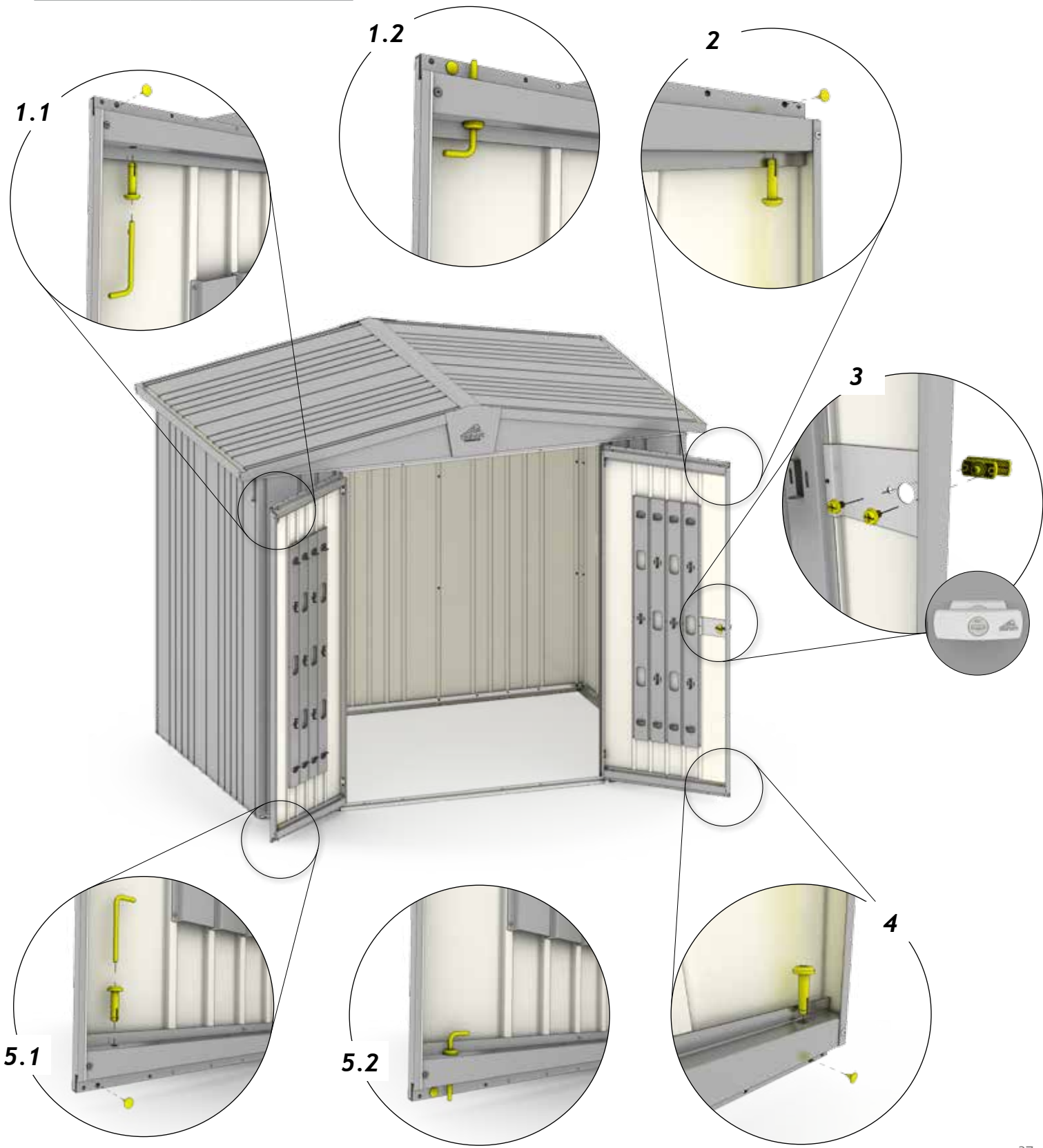

# 15.

 <b>(D1)</b>	1: 2x 4A: 2x 2: 2x 5: 2x 2A: 2x 6: 2x 3: 2x 7: 2x 4: 2x	 <b>(D1)</b>	1: 4x 4A: 4x 2: 4x 5: 4x 2A: 4x 6: 4x 3: 4x 7: 4x 4: 4x	 <b>(D1)</b>	1: 1x 4A: 1x 2: 1x 5: 1x 2A: 1x 6: 1x 3: 1x 7: 1x 4: 1x
 <b>(D1)</b>	1: 4x 4A: 4x 2: 4x 5: 4x 2A: 4x 6: 4x 3: 4x 7: 4x 4: 4x				



 U	1: 2x	4A: 2x	 D1	1: 1x	4A: 1x	 D1	1: 1x	4A: 1x
	2: 2x	5: 2x		2: 1x	5: 1x		2: 1x	5: 1x
	2A: 2x	6: 2x		2A: 1x	6: 1x		2A: 1x	6: 1x
	3: 2x	7: 2x		3: 1x	7: 1x		3: 1x	7: 1x
	4: 2x			4: 1			4: 1x	

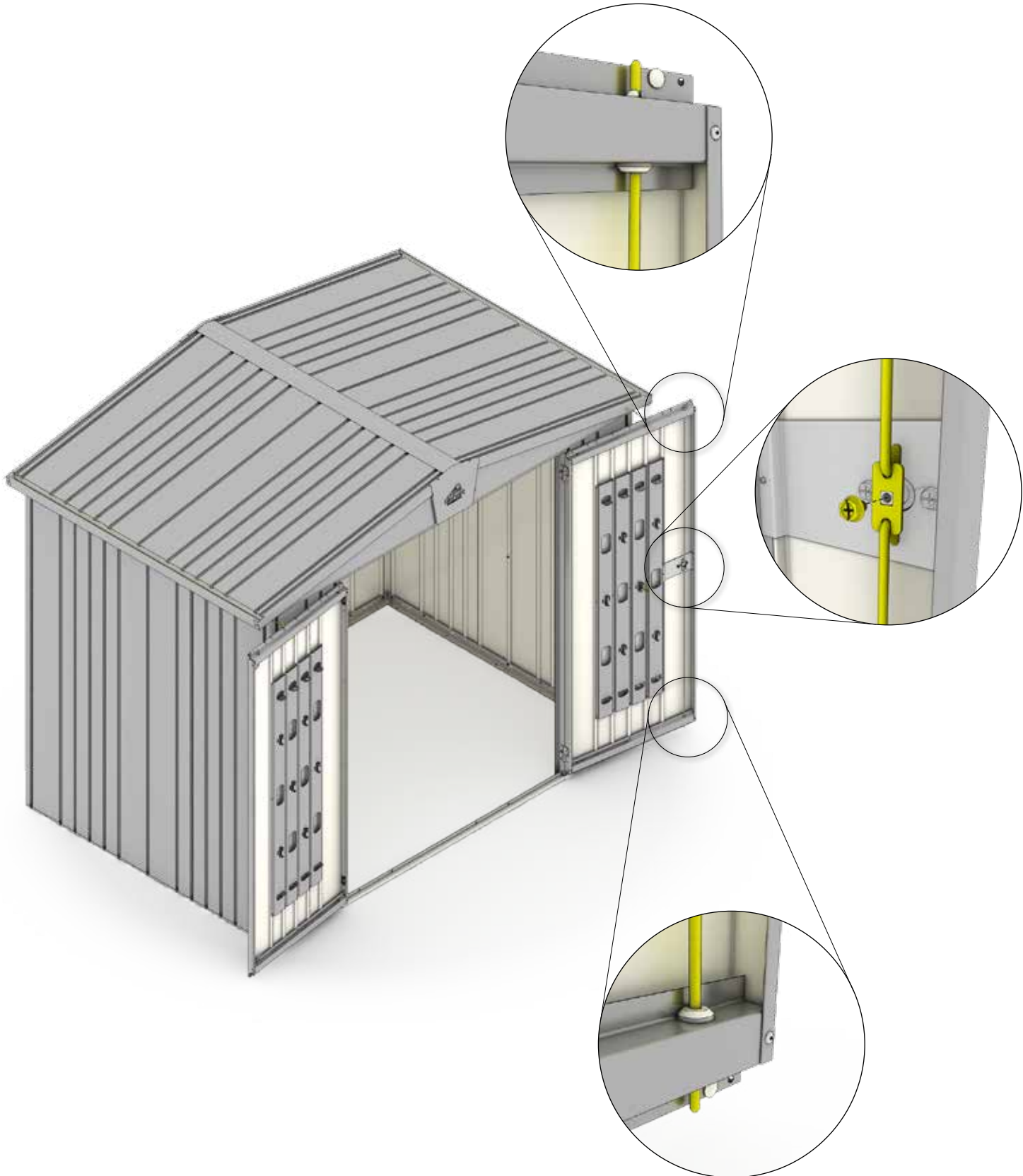

16.



1: 2x 4A: 2x  
2: 2x 5: 2x  
2A: 2x 6: 2x  
3: 2x 7: 2x  
4: 2x



1: 2x 4A: 2x  
2: 2x 5: 2x  
2A: 2x 6: 2x  
3: 2x 7: 2x  
4: 2x

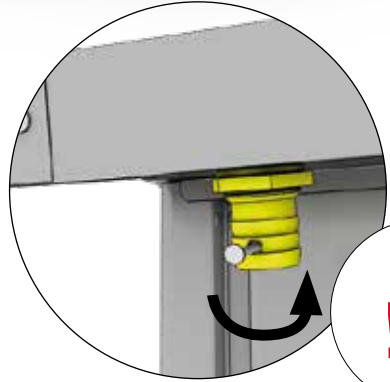
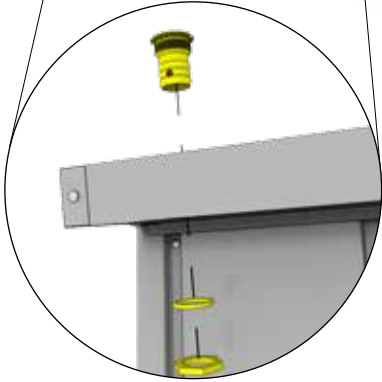
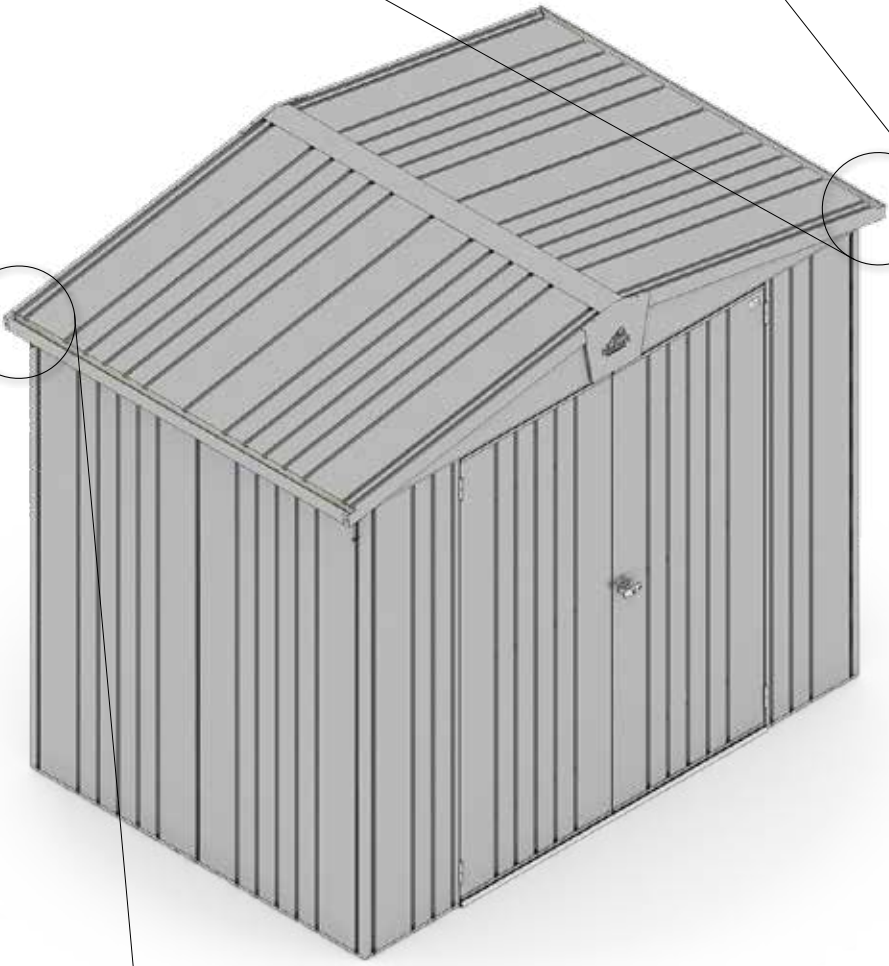
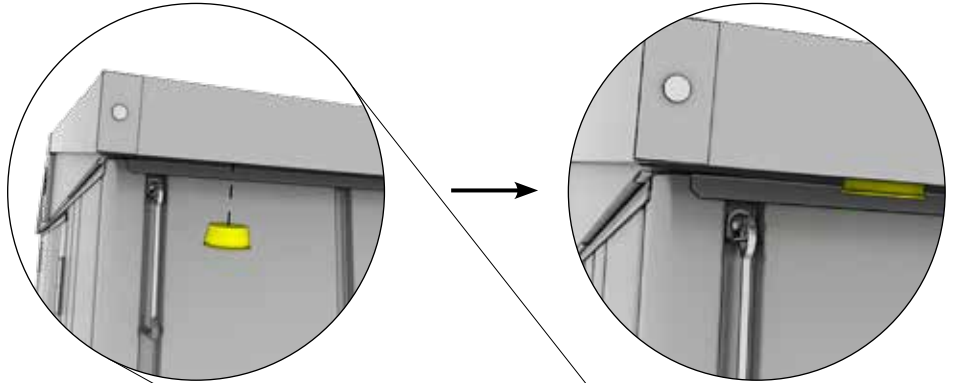

17.



- 1: 1x    4A: 1x
- 2: 1x    5: 1x
- 2A: 1x    6: 1x
- 3: 1x    7: 1x
- 4: 1x

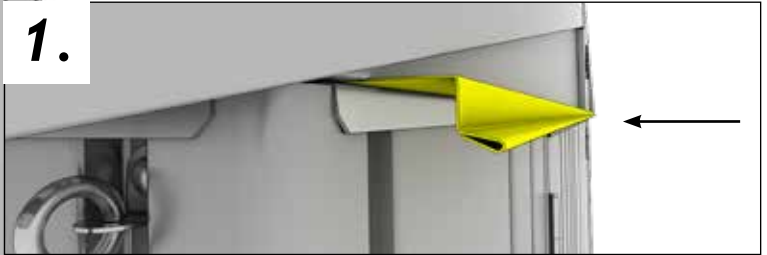
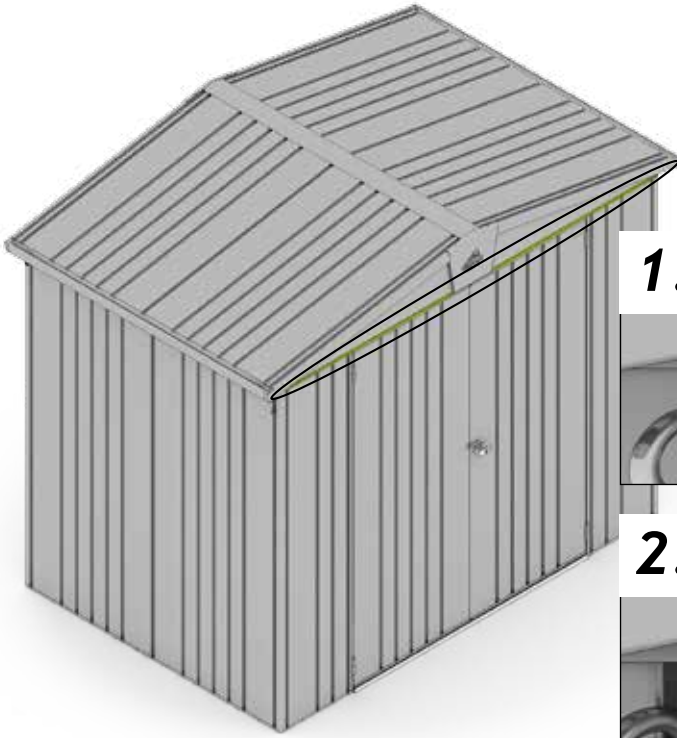

18.

### Tür einrichten

- Ⓒ align the door
- Ⓕ ajuster la porte
- Ⓖ deur afstellen
- Ⓔ ajuste la puerta
- Ⓙ aggiustare la porta
- Ⓚ justering af dør

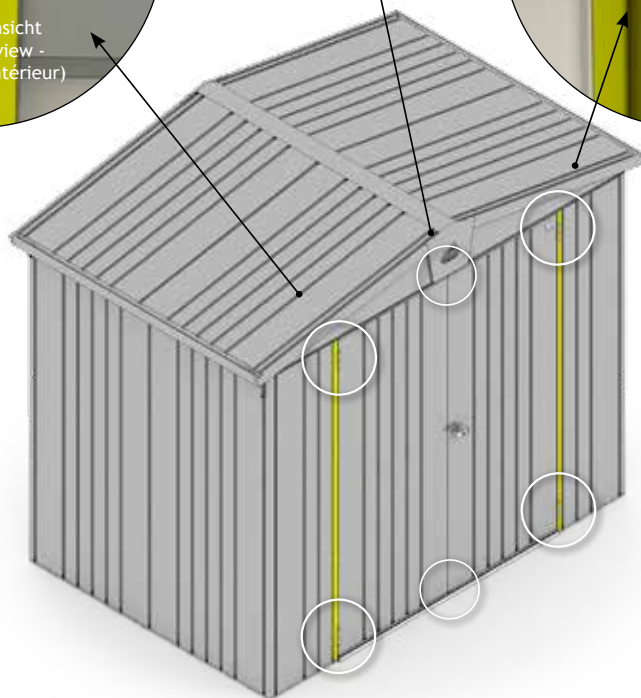
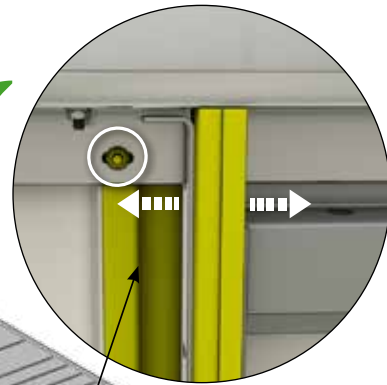
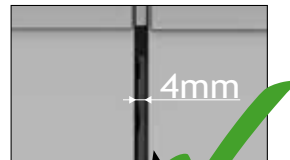
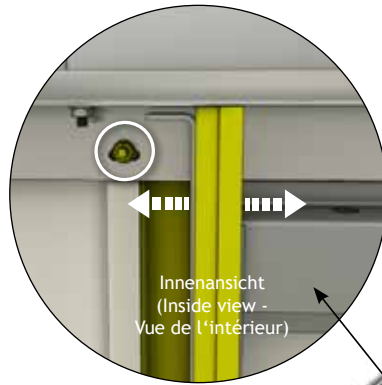



 <b>D1</b>	1: 4x	4A: 4x
	2: 4x	5: 4x
	2A: 4x	6: 4x
	3: 4x	7: 4x
	4: 4x	

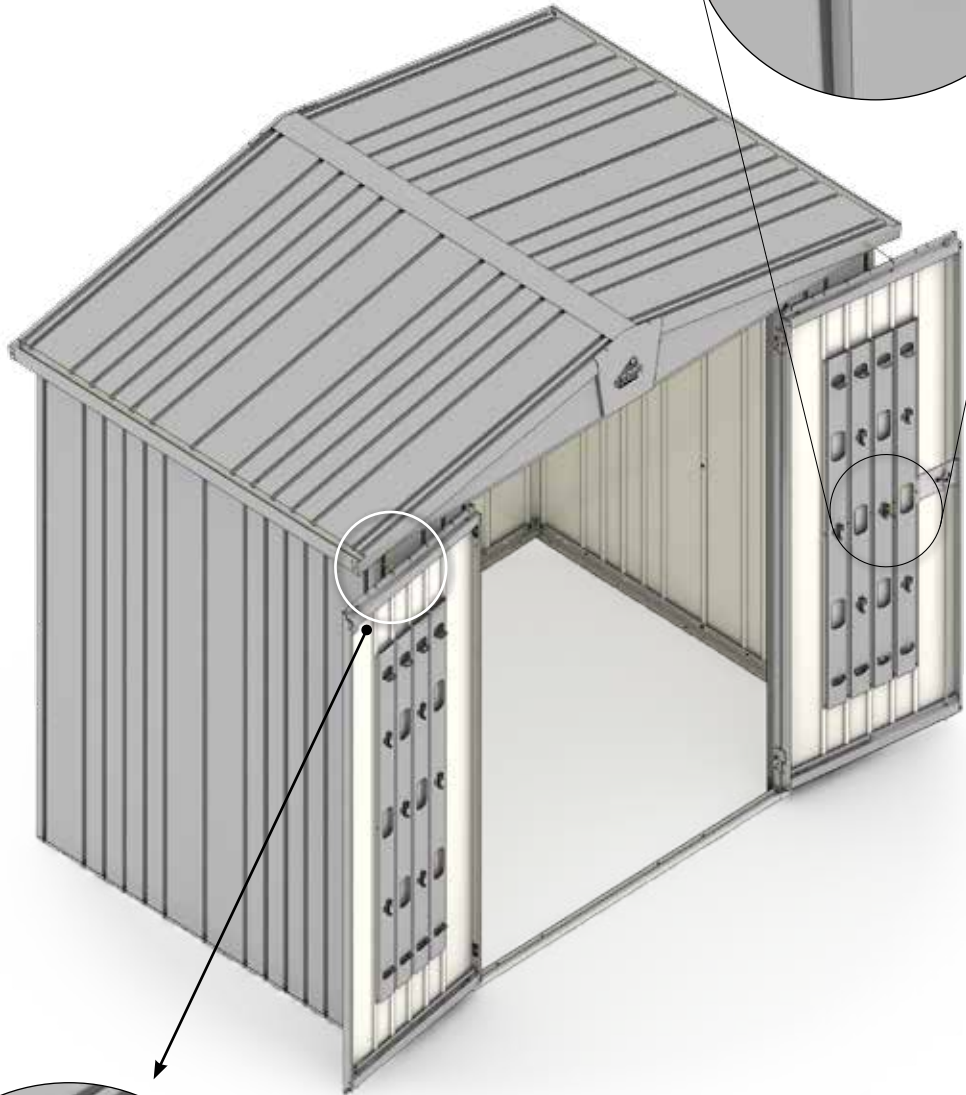

### **Funktion Windhaken**

*function of the door hooks, fonction des crochets de porte*

19.



D2

1: 6x	4A: 6x
2: 6x	5: 6x
2A: 6x	6: 6x
3: 6x	7: 6x
4: 6x	

### Rechtwinkelig einrichten

- Ⓒ rectangular adjusted
- Ⓕ ajuster en forme rectangulaire
- Ⓖ rechthoekig instellen
- Ⓔ ajustar en forma rectangular
- Ⓜ mettere in forma rettangolare
- Ⓓ indstil vinkelret

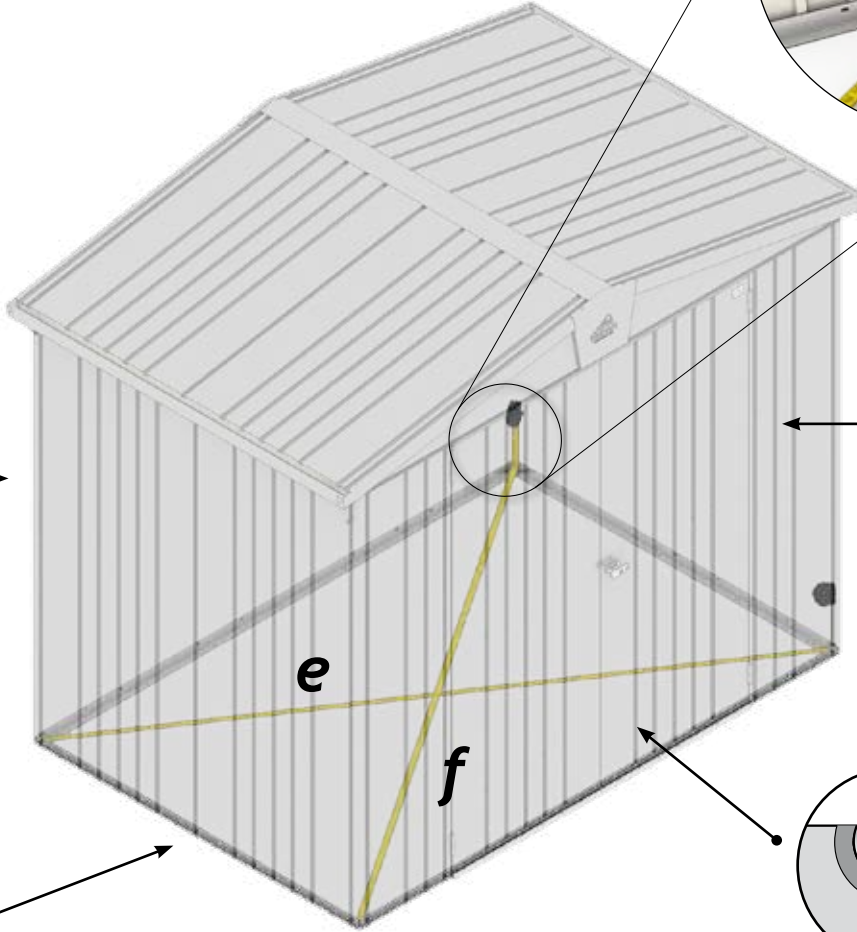
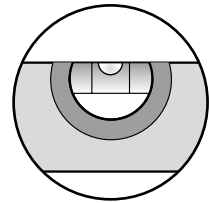
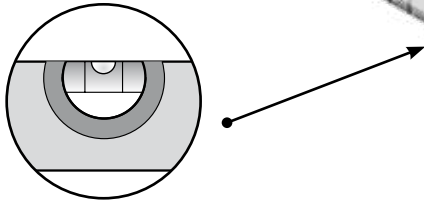
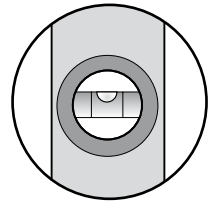
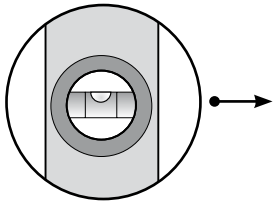

$e = f$



### Ziehen Sie jetzt alle Schraubverbindungen fest an!

Tighten now all nuts and connections securely! - Serrez maintenant les vis à fond! - Draai nu alle schroeven vast! - Ahora puede apretar y fijar todos los tornillos y tuercas - Adesso serrare a fondo tutti i dadi - Fastspænd nu alle bolt-/skruerforbindelser!

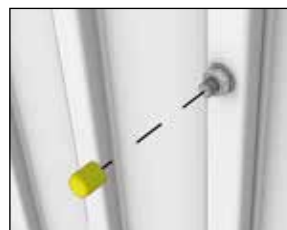
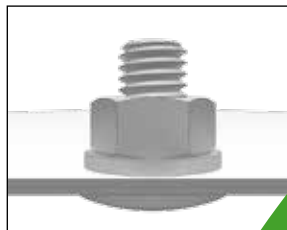





# Bodenrahmen

Floor Frame - Cadre de sol - Bodemframe - Marco de suelo - Telaio perimetrale - Bundramme

## Variante 1, Proposal 1, Variant 1

		1: 4x	4A: 8x
		2: 6x	5: 10x
		2A: 6x	6: 10x
		3: 8x	7: 10x
		4: 8x	

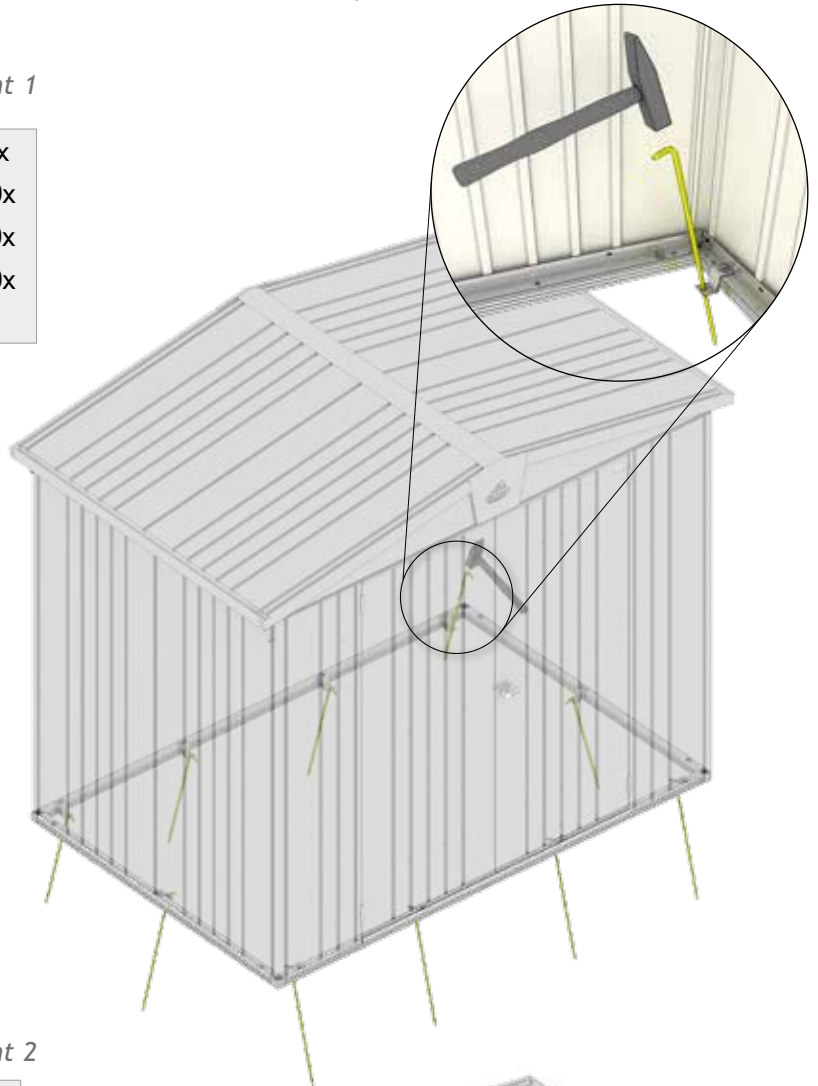
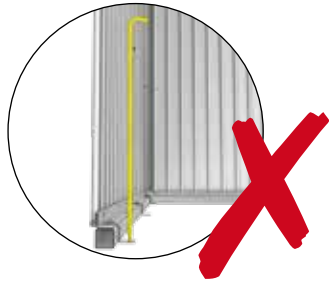

## Variante 2, Proposal 2, Variant 2

	8 x 60	1: 8x	4A: 8x
		2: 8x	5: 8x
		2A: 8x	6: 8x
		3: 8x	7: 10x
		4: 8x	

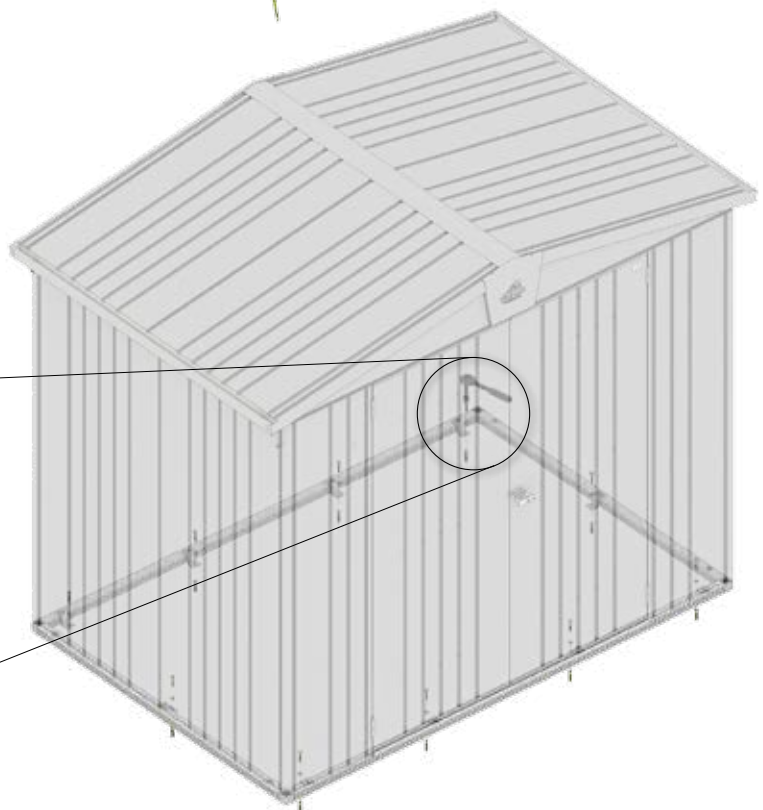
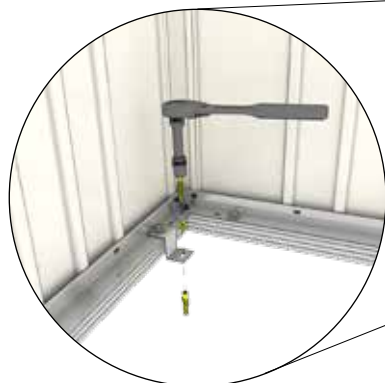

8 x 60  D1	1: 8x	4A: 8x
	2: 8x	5: 8x
	2A: 8x	6: 8x
	3: 8x	7: 8x
	4: 8x	

### Variante 3,

Proposal 3, Variant 3

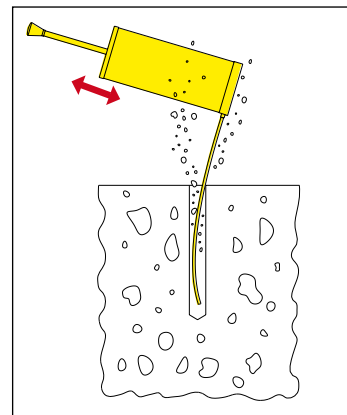
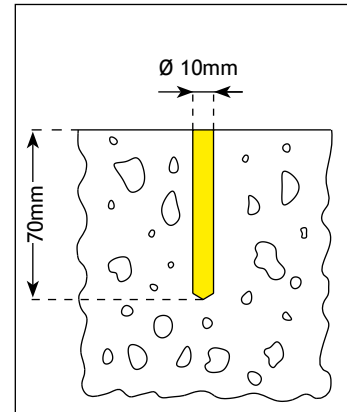
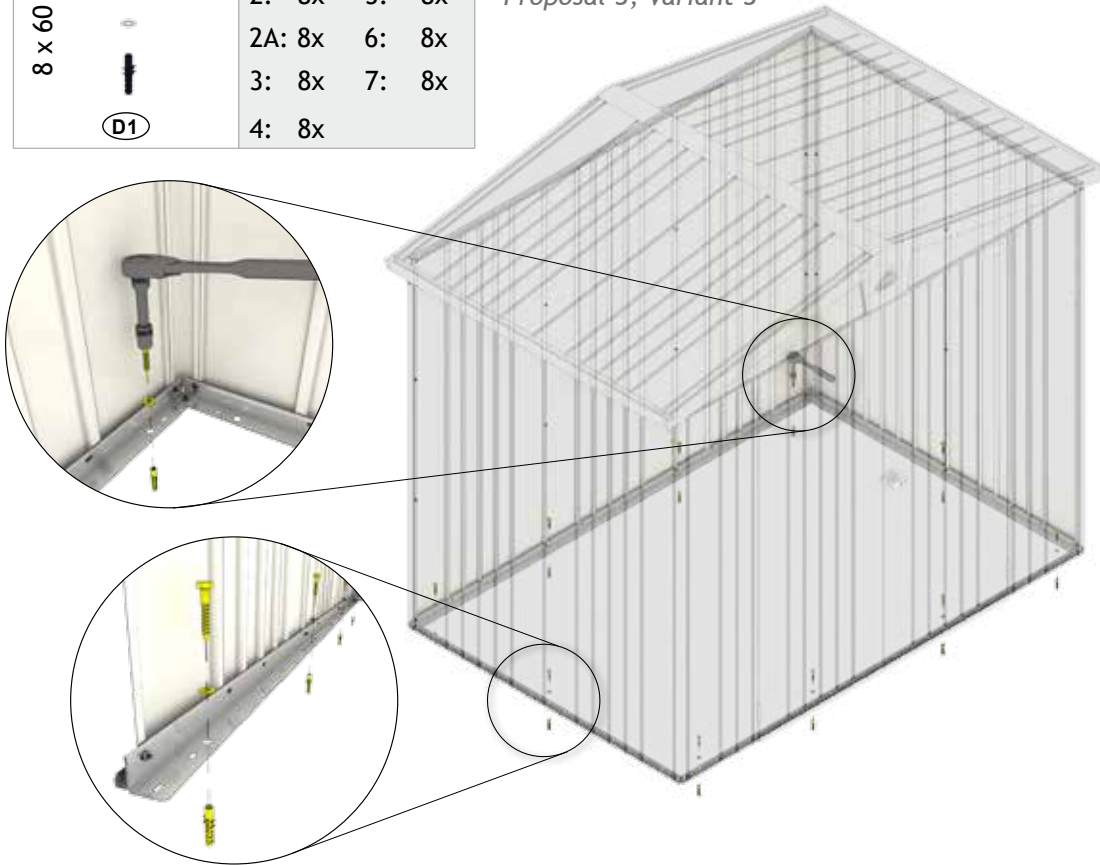

Größenabhängiger Montageschritt - Size-Dependent assembly step - Dépendant de la taille - Size-Dependent montagestep

### Nur für Größe 2A und 4A

Only for size 2A and 4A - Uniquement pour taille 2A et 4A - Alleen voor maat 2A en 4A - Sólo para los tamaños 2A y 4A - Solo per misura 2A e 4A - Kun for størrelse 2A og 4A

 X	2A: 2x
	4A: 2x

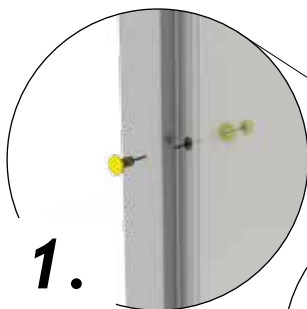

1.

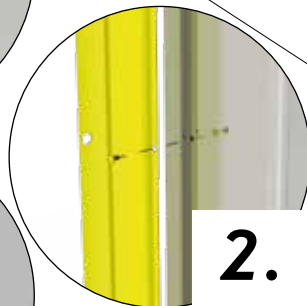

2.

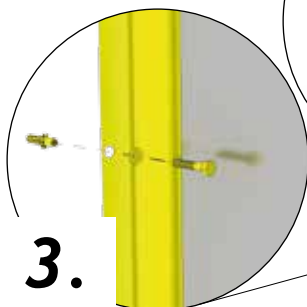

3.

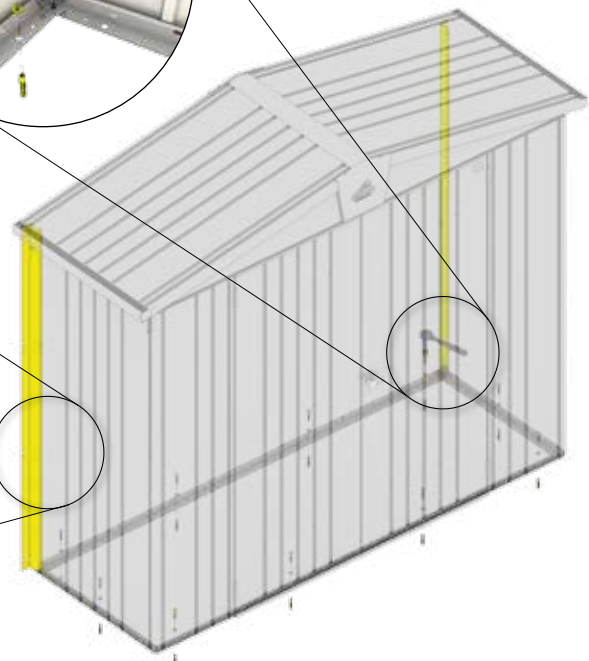

Paso de montaje de tamaño Dependiente - Taglia-Dependent fase di montaggio - Størrelses-anhængig montage skridt



20.

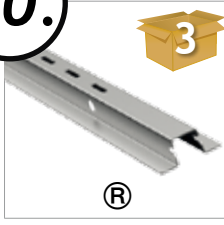

1: 2x 4A: 2x  
 2: 2x 5: 2x  
 2A: 2x 6: 2x  
 3: 2x 7: 2x  
 4: 2x



1: 2x 4A: 2x  
 2: 2x 5: 2x  
 2A: 2x 6: 2x  
 3: 2x 7: 2x  
 4: 2x



1: 4x 4A: 4x  
 2: 4x 5: 4x  
 2A: 4x 6: 4x  
 3: 4x 7: 4x  
 4: 4x

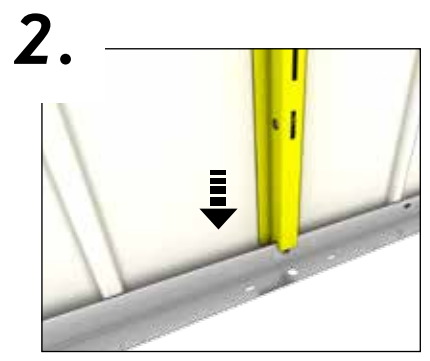
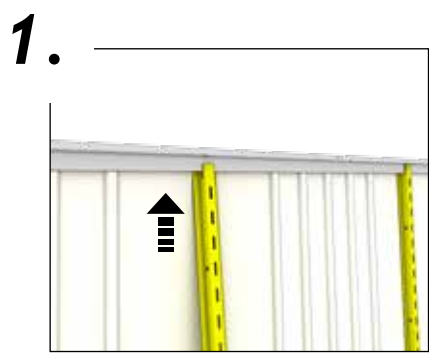

**Option 1:**

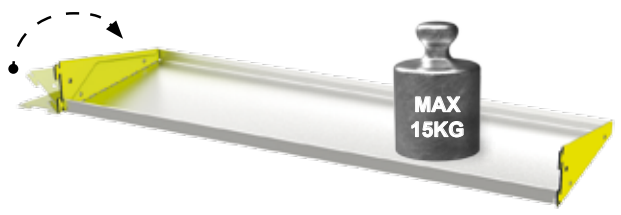

**Option 2:**

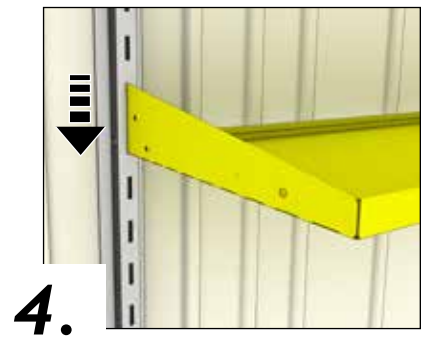
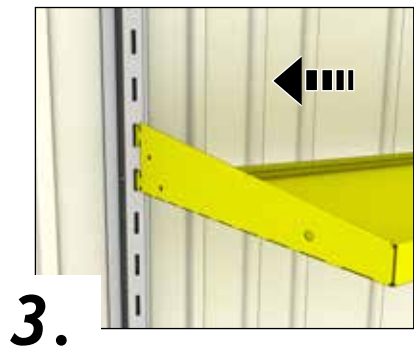
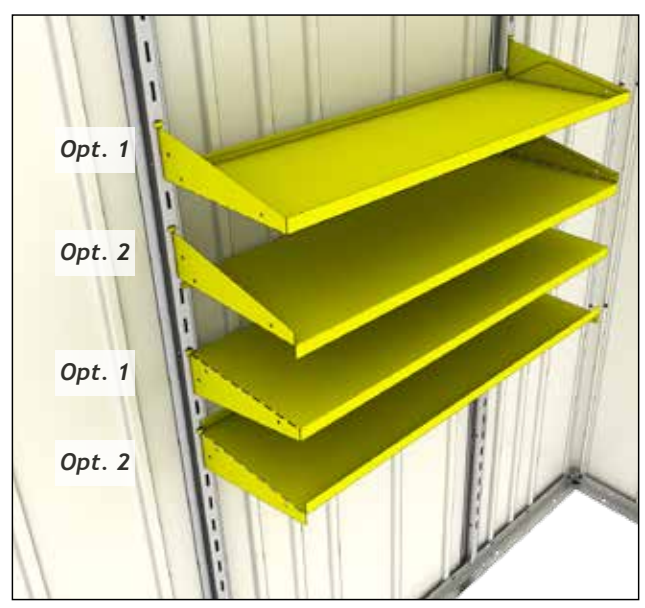

21.

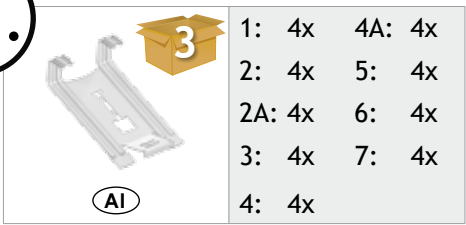

1:	4x	4A:	4x
2:	4x	5:	4x
2A:	4x	6:	4x
3:	4x	7:	4x
4:	4x		

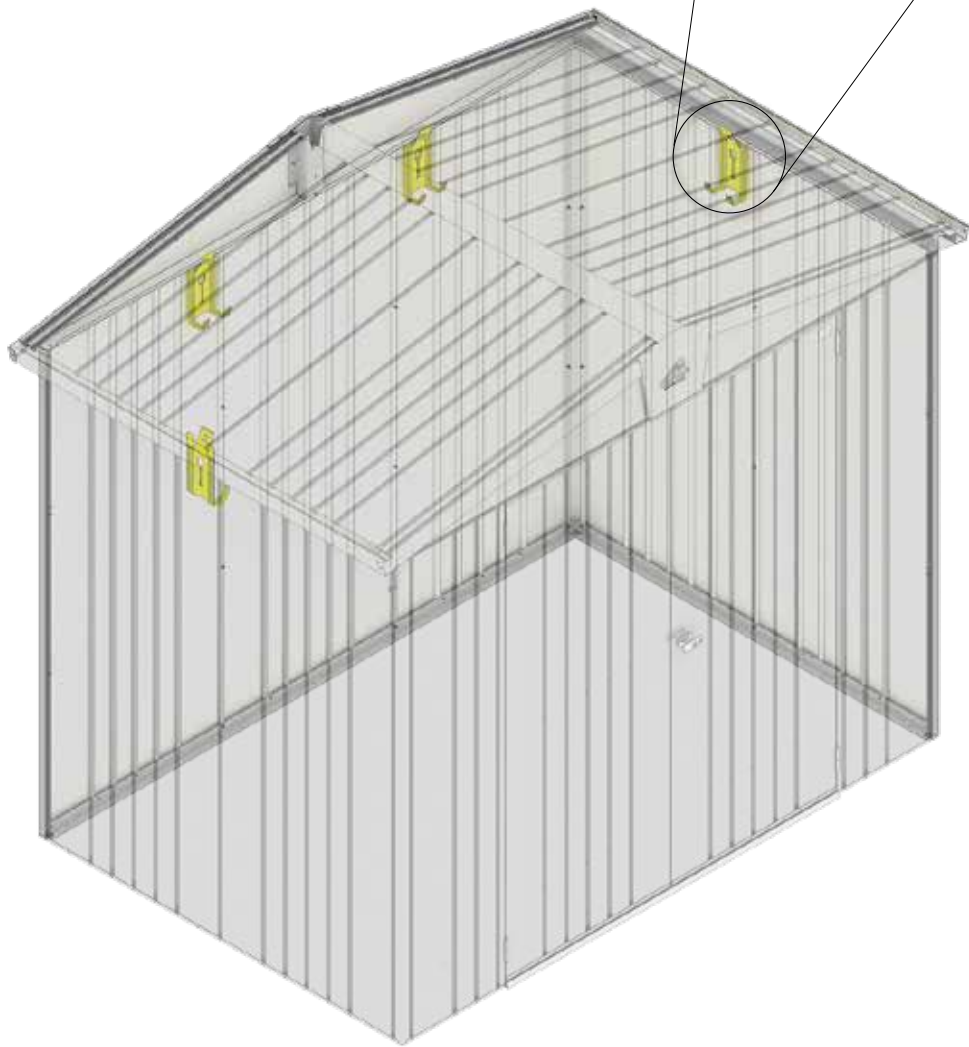



# Regenfallrohr

Rain water downpipe - Descente d'eaux pluviales - Regenpijpset - Set di tubi pluviali - Set de bajante - Tagnedløb

	1: 2x	4A: 2x		M4 x 10	1: 4x	4A: 4x
	2: 2x	5: 2x		2: 4x	5: 4x	
	2A: 2x	6: 2x		2A: 4x	6: 4x	
	3: 2x	7: 2x		3: 4x	7: 4x	
	4: 2x			4: 4x		

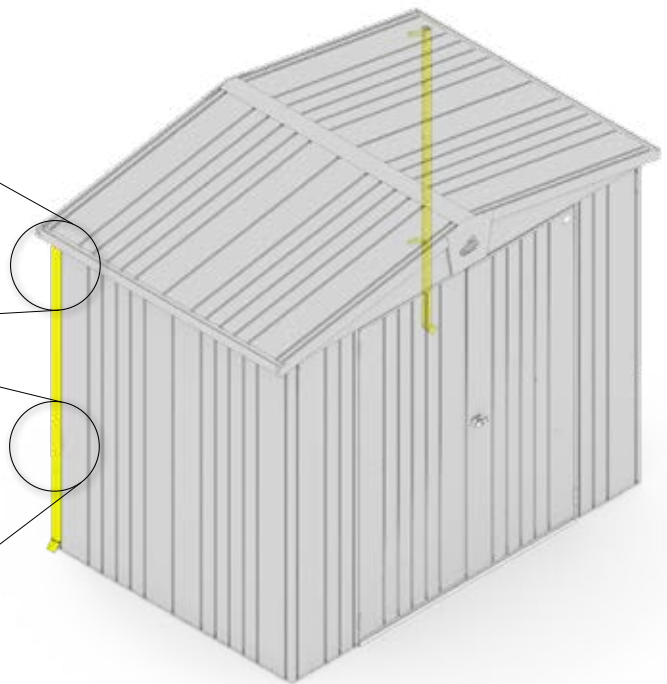
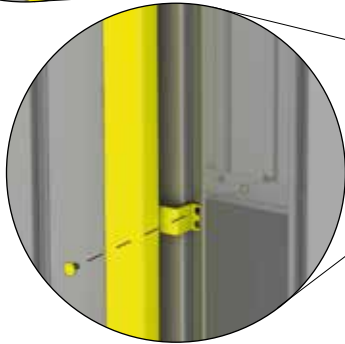
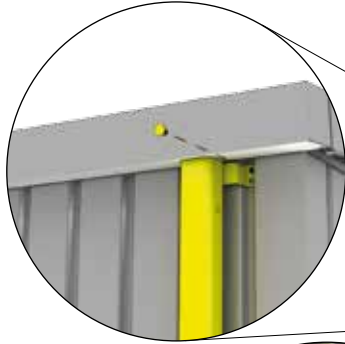

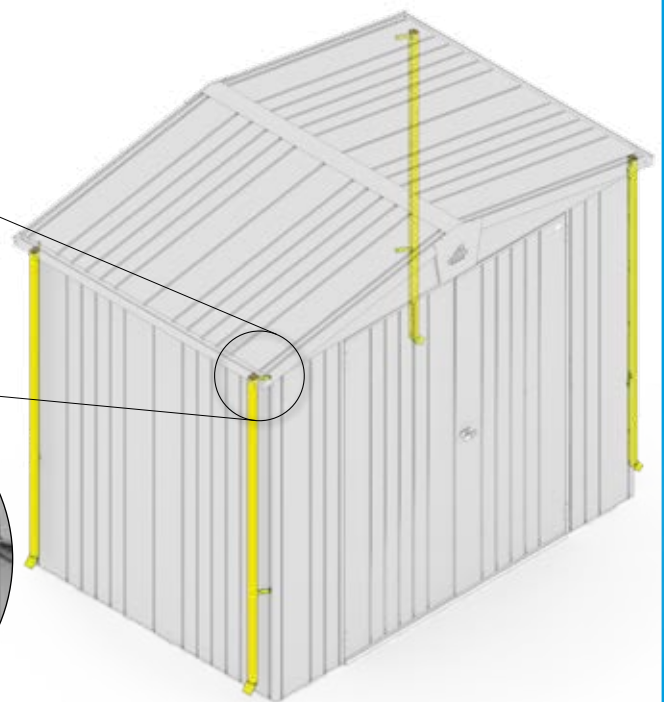
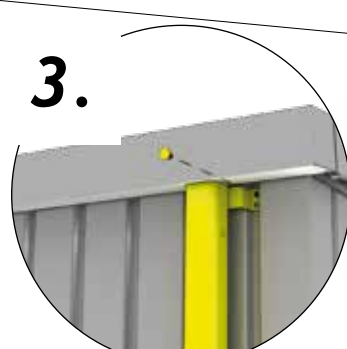
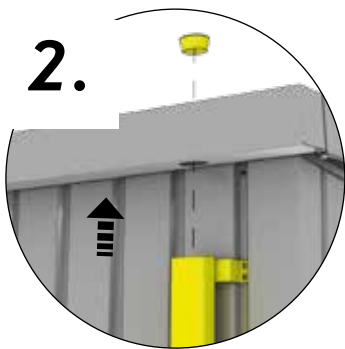
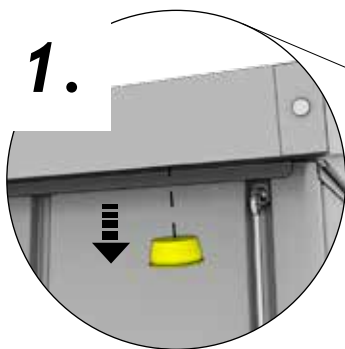

	1: 4x	4A: 4x		M4 x 10	1: 8x	4A: 8x		1: 2x	4A: 2x
	2: 4x	5: 4x		2: 8x	5: 8x	2: 2x		5: 2x	
	2A: 4x	6: 4x		2A: 8x	6: 8x	2A: 2x		6: 2x	
	3: 4x	7: 4x		3: 8x	7: 8x	3: 2x		7: 2x	
	4: 4x			4: 8x		4: 2x			



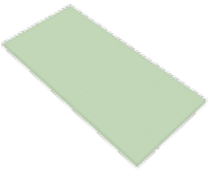
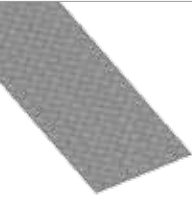

## Bodenplatte

Floor Panels - Plaque de fond - Bodemplaatt - Placa de suelo - Pavimentazione - Bundplade

	1: 4x	4A: 8x		1: 1x	4A: 4x		2: 1x	5: 3x
	2: 6x	5: 10x		2: 2x	5: 4x		3: 1x	6: 3x
	2A: 6x	6: 10x		2A: 1x	6: 4x		4: 2x	7: 3x
	3: 8x	7: 10x		3: 2x	7: 4x		4A: 3x	
	4: 8x			4: 3x				

### Unterbau für Bodenplatten mit XPS-Platten (2cm od. 3cm)

(nicht im Lieferumfang)

- Ⓒ Substructure of the floor panels with XPS-boards (2 cm | 3 cm) (not included in the scope of delivery)
- Ⓕ Les plaques XPS (2 cm | 3 cm) pour les plaques de fond ne sont pas fournies.
- Ⓖ De XPS- platen (2cm | 3 cm) die onder de bodemplaatt komen, zijn bij de levering niet inbegrepen.
- Ⓔ Las placas de poliestireno extruido XPS (2cm o 3 cm de altura) sobre las que se coloca la placa de suelo no forman parte del suministro.
- Ⓙ Placche XPS (2cm | 3 cm) per basamento di una pavimentazione in alluminio (on fornite in dotazione).
- Ⓚ Underlæg for bundplader med XPS-plader (2 cm eller 3 cm) , (følger ikke med)

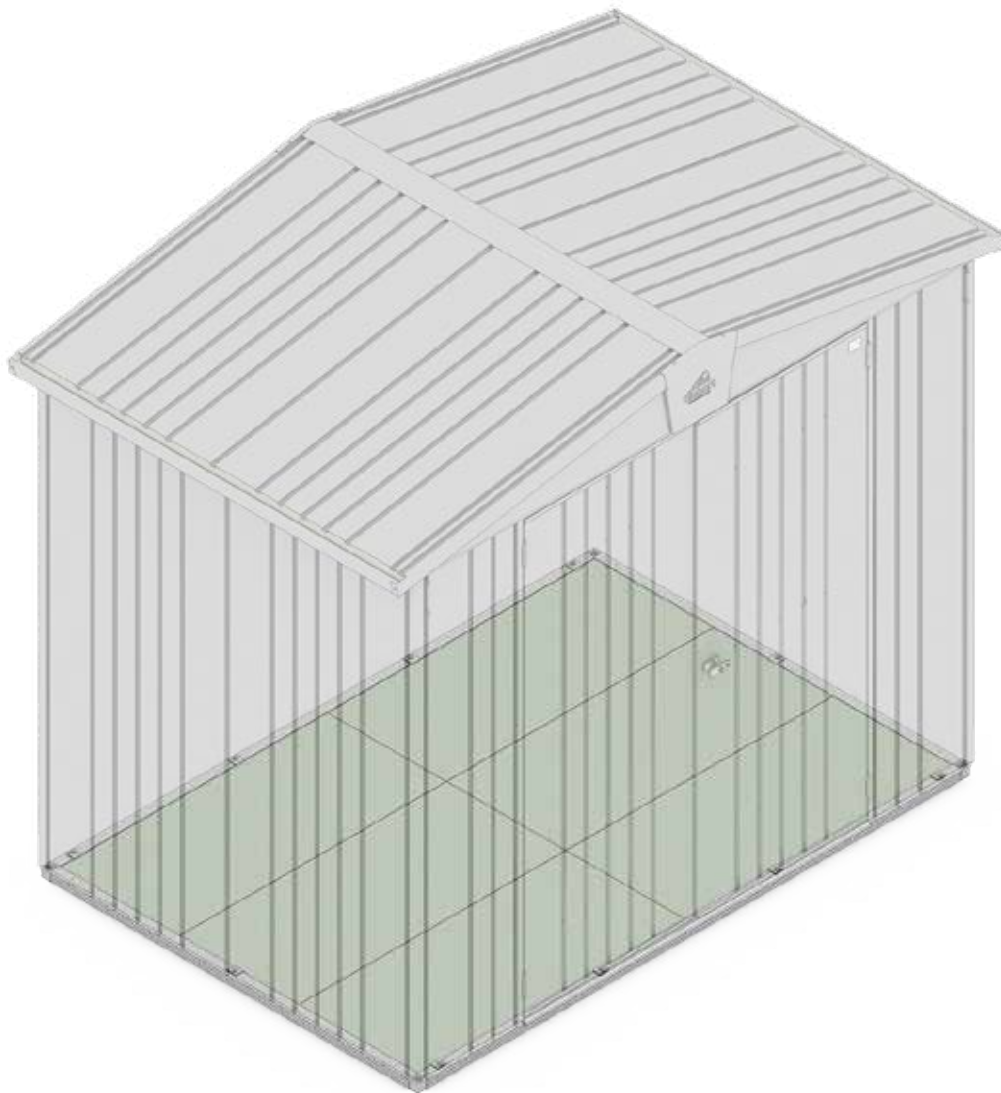



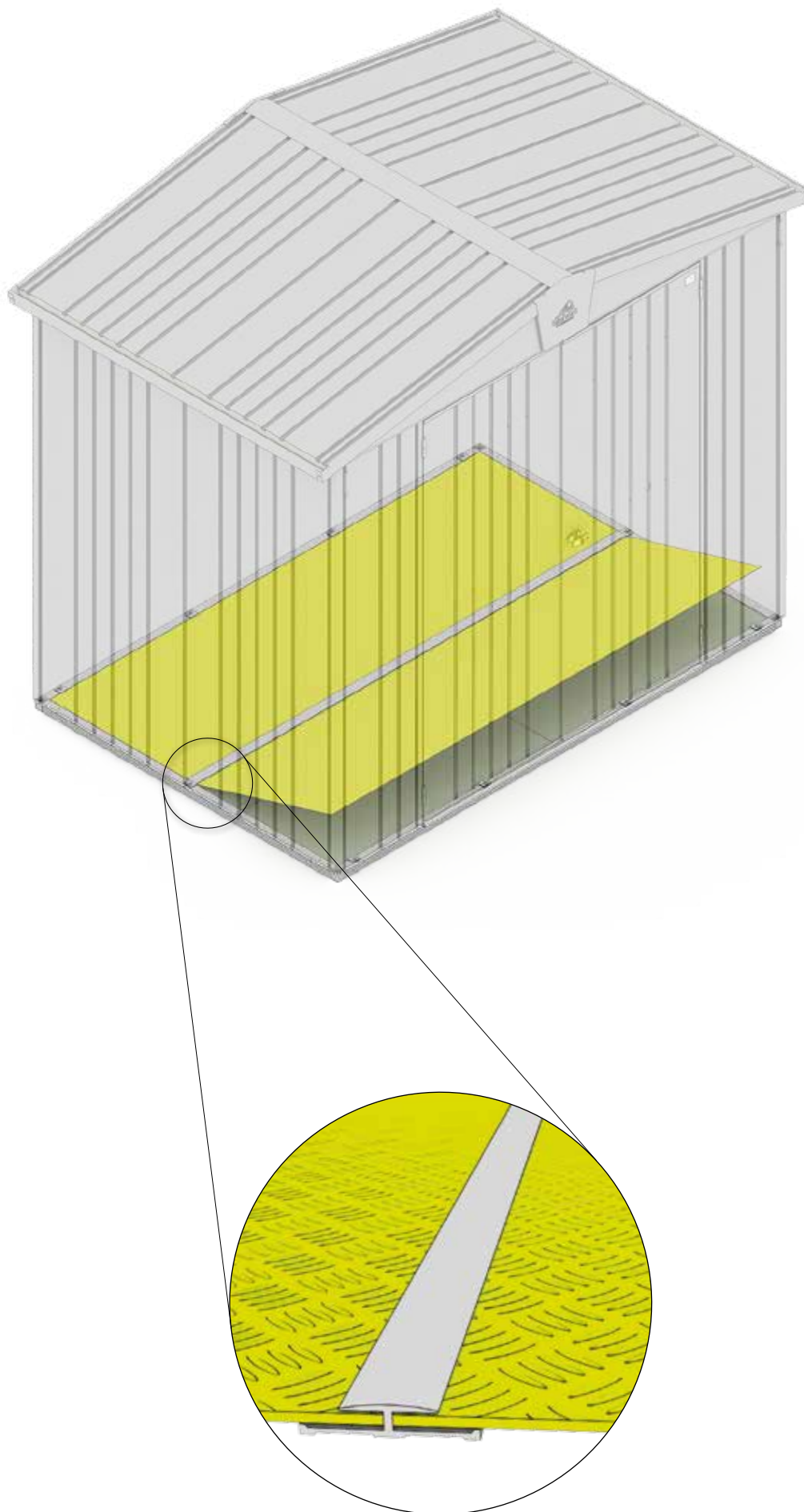

# Einreichplan

für die Aufstellung eines  
Biohort-Gerätehauses  
Modell „Europa“

Approval plan  
for the erection of  
Biohort garden shed  
model "Europa"

Demande  
d'autorisation pour la  
mise en place d'un abri  
de jardin Biohort modèle  
« Europa »

Plan van  
goedkeuring  
voor het bouwen van  
het Biohort tuinhuis  
model "Europa"

Adresse Aufstellort / Address at site of erection / Adresse du terrain / Platsingsadres

Grundbuch-Einlagezahl  
Land register-Site No. / Cadastre  
Katastralgemeinde

Grundstücks-Nr.  
Property No. / Parcelle n°  
Kadastraal nummer

Katastralgemeinde  
Council/Borough responsible  
Section/Commune / Eigendomsnummer

## Bauwerber

Building applicant

Demandeur / Opbouwer

Vorname / Christian name / Prénom / Voornaam

Familienname / Surname / Nom / Achternaam

Anschrift / Address / Adresse / Adres

Unterschrift des Bauwerbers / Signature of applicant / Signature du demandeur / Handtekening eigenaar

## Grundstückseigentümer

Property owner

Propriétaire du terrain

Landeigenaar

Vorname / Christian name / Prénom / Voornaam

Familienname / Surname / Nom / Achternaam

Anschrift / Address / Adresse / Adres

Unterschrift des Grundstückseigentümers / Signature of property owner  
Signature du propriétaire / Handtekening eigenaar

## Bodenfläche des Biohort-Gerätehauses:

Floorspace of biohort garden shed:  
Surface au sol de l'abri de jardin Biohort :  
Oppervlakte van het Biohort tuinhuis:

- o Größe 1 / Size 1 / Taille 1 / Grootte 1 = 1,22 m<sup>2</sup>
- o Größe 2 / Size 2 / Taille 2/ Grootte 2 = 2,31 m<sup>2</sup>
- o Größe 2A / Size 2A / Taille 2A / Grootte 2A = 1,80 m<sup>2</sup>
- o Größe 3 / Size 3 / Taille 3 / Grootte 3 = 3,40 m<sup>2</sup>
- o Größe 4 / Size 4 / Taille 4 / Grootte 4 = 5,02 m<sup>2</sup>
- o Größe 4A / Size 4A / Taille 4A / Grootte 4A = 4,62 m<sup>2</sup>
- o Größe 5 / Size 5 / Taille 5 / Grootte X5 = 6,63 m<sup>2</sup>
- o Größe 6 / Size 6 / Taille 6 / Grootte 6 = 6,63 m<sup>2</sup>
- o Größe 7 / Size 7 / Taille 7 / Grootte 7 = 8,76 m<sup>2</sup>

## Gesamte bebaute Fläche

Total built-up area / Surface totale bâtie / Totaal bebouwde oppervlakte

## Gartenfläche

Garden area / Surface du jardin / Tuin oppervlakte

## Altbau bewilligt

Erection authorised by  
Permis de construire du bâtiment existant sur le terrain N°  
Opdracht tot opbouw door

vom

Date / En date du / Datum

## Verein

Association / Société / Vereniging

## Lageplan 1 : 500

Siteplan 1 : 500  
Plan de masse 1 : 500  
Map 1 : 500

Maße siehe Rückseite. / For dimensions see reverse side. / Voir au verso pour les dimensions. / Voor maten zie ommezijde.

# Abmessungen Gerätehaus „Europa“ in mm

dimensions garden shed "Europa" in mm

dimensions des abri de jardin « Europa » en mm

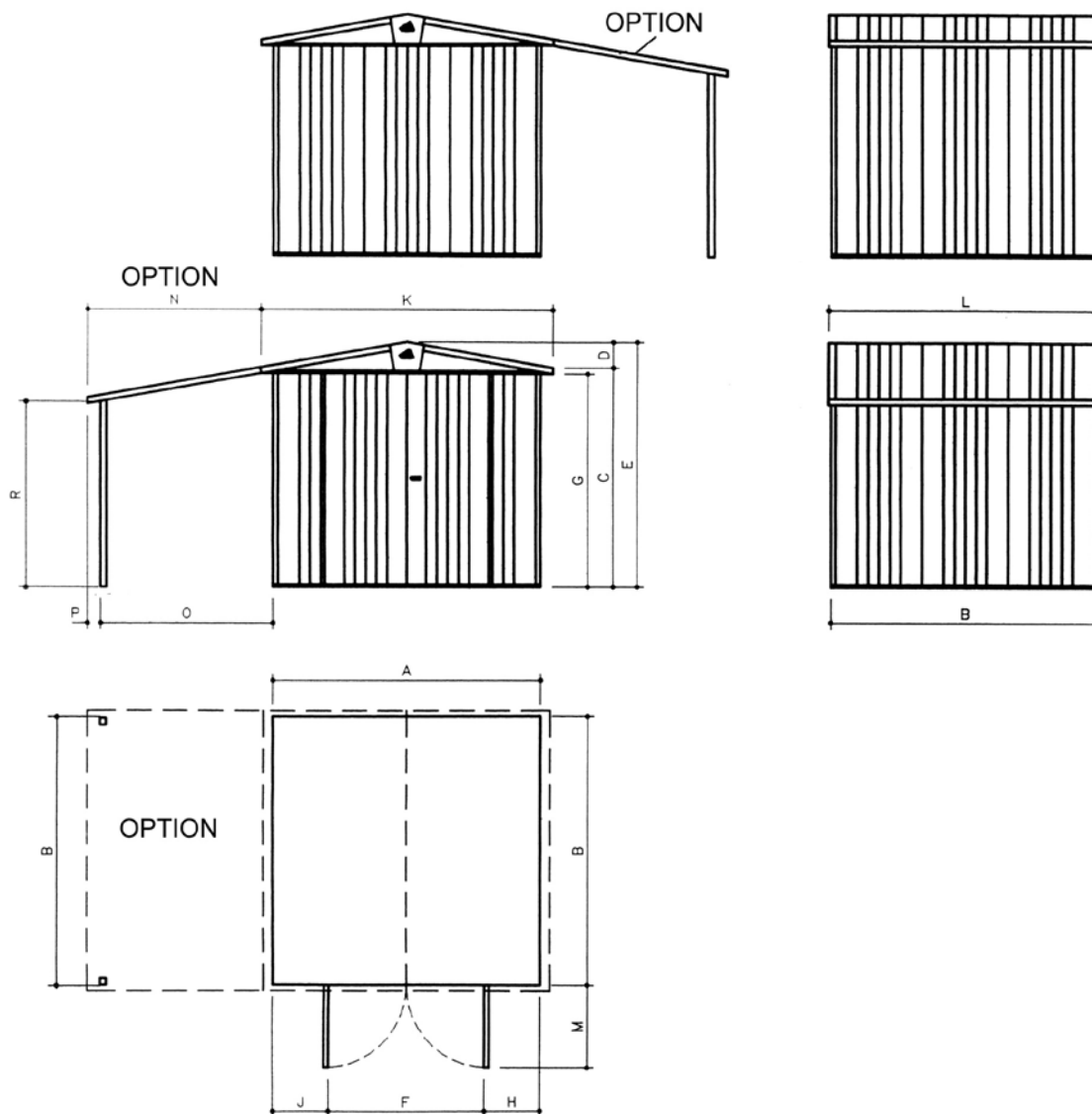

Gerätehausmaße / dimensions		Gerätehaus - Größen / sizes								
Maßbezeichnungen		Größe 1	Größe 2	Größe 2A	Größe 3	Größe 4	Größe 4A	Größe 5	Größe 6	Größe 7
Gerätehausbreite	A	1520	1520	2240	2240	2240	2960	2960	2240	2960
Gerätehauslänge	B	800	1520	800	1520	2240	1520	2240	2960	2960
Gerätehaushöhe bis Rinne	C	1810	1810	1810	1810	1810	1810	1810	1810	1810
Gerätehaushöhe Rinne bis First	D	155	155	220	220	220	285	285	220	285
Gerätehausgesamthöhe	E	1965	1965	2030	2030	2030	2095	2095	2030	2095
Durchgangslichte - Breite	F	1350	1350	1350	1350	1350	1350	1350	1350	1350
Durchgangslichte - Höhe	G	1710	1710	1710	1710	1710	1710	1710	1710	1710
Seitenbreite rechts	H	85	85	85/445/805	85/445/805	85/445/805	85/805/1525	85/805/1525	85/445/805	85/805/1525
Seitenbreite links	J	85	85	805/445/85	805/445/85	805/445/85	1525/805/85	1525/805/85	805/445/85	1525/805/85
Dachbreite	K	1720	1720	2440	2440	2440	3160	3160	2440	3160
Dachlänge	L	840	1560	840	1560	2280	1560	2280	3000	3000
Türplatzbedarf beim Öffnen	M	700	700	700	700	700	700	700	700	700
Dachbreite Seitendach	N		1445		1445	1445	1445	1445	1445	1445
Seitenbreite bis Seitendachstütze	O		1445		1445	1445	1445	1445	1445	1445
Dachvorsprung Seitendach	P		100		100	100	100	100	100	100
Durchgangshöhe seitlich	R		1560		1560	1560	1560	1560	1560	1560



### HighLine®

Das ultimative Gerätehaus, das hinsichtlich Sicherheit und Funktionalität alle Anforderungen erfüllt.



### Panorama®

Dieses Satteldachmodell passt in jedes Gartenpanorama. Stabilität und Design für höchste Ansprüche.



### AvantGarde®

Passt bestens zu moderner Architektur und macht lebenslang Freude.



### Europa

Alles in bester Ordnung und lebenslange Wartungsfreiheit mit dem Biohort-Klassiker.



### Geräteschrank

Wo Raum knapp ist, zeigt er seine Klasse – im Garten, auf der Terrasse, in der Garage.



### MiniGarage

Multifunktionales Stauraumwunder ohne Genehmigungspflicht.



### WoodStock®

Kaminholzlager und Geräteschrank in einem, auch zum einfachen Wand-Anbau geeignet.



### StoreMax®

Funktionelles Design für maximalen Stauraum auf wenig Platz.



### HighBoard

Das formvollendete Multitalent zum Aufbewahren. Mit Flügeltüren und Deckelöffnung.



### CornerBoard

Bietet wertvollen Platz auf Balkon und Terrasse.



### LoungeBox®

Die Design-Box für gehobene Ansprüche - ein Schmuckstück für Terrasse und Garten.



### FreizeitBox

Ideal zum Verstauen von Sitzkissen, Sonnenliegen und Spielzeug.



### HochBeet

Schönste Aussicht auf beste Ernte.



### Pflanzbeet Belvedere®

Der Blickfang für die Terrasse.

NEU



### Komposter MonAmi®

Vereint Zweckmäßigkeit mit stilvollem Auftreten.

NEU

**EXTRA PROSPEKT**  
anfordern unter  
[www.biohort.com](http://www.biohort.com)



### Nebengebäude CasaNova®

Design, das sich Ihren Wünschen anpasst.



**Biohort GmbH**

Pürnstein 43, 4120 Neufelden, Österreich  
Tel.: +43-7282-7788-0, Fax-DW: 190  
E-Mail: [office@biohort.at](mailto:office@biohort.at), [www.biohort.com](http://www.biohort.com)

Ihr Fachhändler:

