

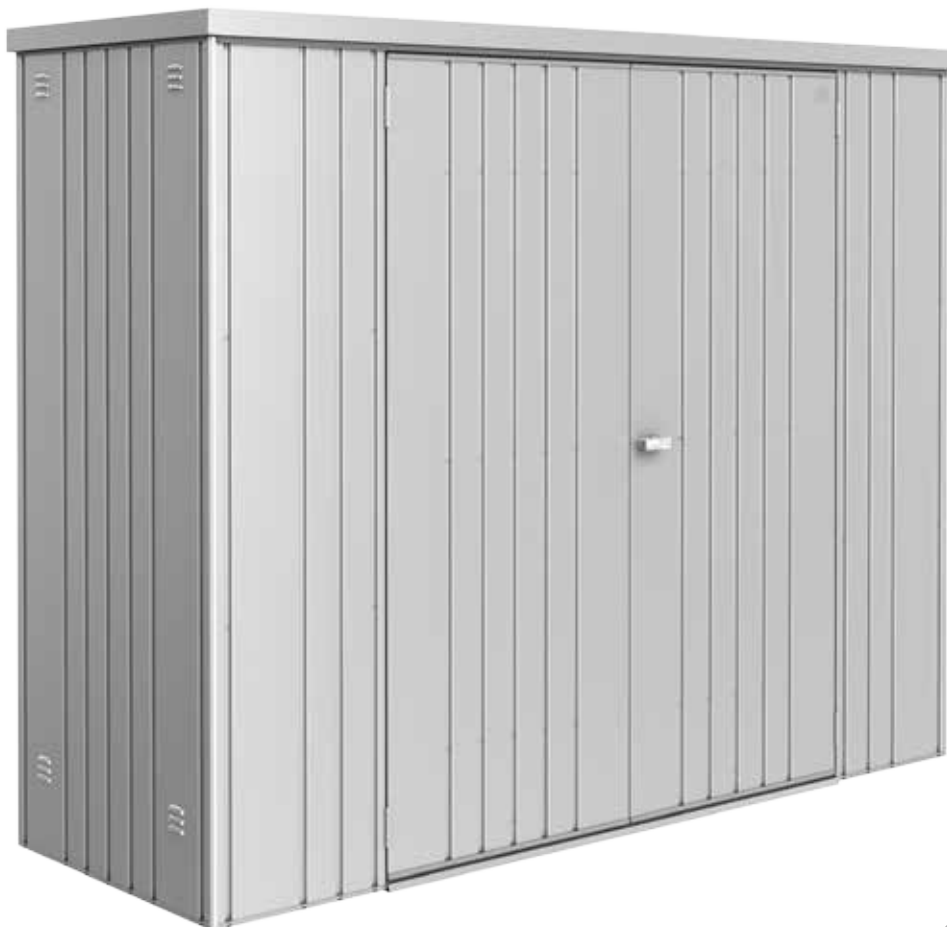



DE Aufbauanleitung für Geräteschrank Größe 90, 150 und 230

- Ⓞ GB Assembly manual for equipment locker - size 90,150 and 230
- Ⓞ FR Notice de montage pour l'armoire à outils - taille 90,150 et 230
- Ⓞ NL Opbouwbeschrijving voor de Tuinkast - grootte 90,150 en 230
- Ⓞ ES Instrucciones de montaje del armario de jardín - tamaño 90,150 y 230
- Ⓞ IT Istruzioni di montaggio Armadio per attrezzi - misura 90,150 e 230
- Ⓞ DK Monteringsvejledning for Redskabsrum - størrelse 90, 150 og 230



 Poišćite vař prevod na ...

 Najděte svůj překlad ...

 Hitta din översättning ...

 Finn din oversettelse ...

 Találja meg fordítását ...

! Wichtige Punkte für den Aufbau!

Vorliegende Aufbauanleitung zeigt den Zusammenbau von „Geräteschrank“ Größe „230“; sie gilt sinngemäß auch für die Größe „90“ & „150“. Für einige Montageschritte benötigen Sie einen Helfer.

- (GB) *Important details regarding assembly! This assembly manual shows the erection of the "Equipment locker" size "230"; it is also valid for size "90" & "150" For several assembly steps additional assistance of one person will be required.*
- (FR) *Points importants lors du montage! " Cette notice de montage décrit l'assemblage du produit « Armoire à outils » taille « 230 »; celle-ci est aussi valable pour la taille «90» «150». Pour certaines étapes, demandez l'aide d'une personne.*
- (NL) *Deze montage instructies hebben betrekking op de opbouw van de Tuinkast , grootte 230. De instructies zijn ook van toepassing op de grootte 90 & 150. Voor enkele montage stappen heeft u 1 persoon nodig om u te helpen.*
- (ES) *Notas importantes para el montaje: Estas instrucciones muestran el montaje del "Armario de jardín" en tamaño 230. También son válidas para el tamaño 90 & 150. Es recomendable realizar el montaje con una otra persona.*
- (IT) *Indicazioni importanti per il montaggio! Le seguenti istruzioni di montaggio fanno riferimento all'assemblaggio dell' "Armadio per attrezzi" misura "230"; per analogia sono valide anche per la misura "90" & "150". Per alcune fasi di assemblaggio vi serviranno 1 aiutante.*
- (DK) *Vigtige punkter ved samling! Samlemanualen viser opsætningen af modellen "Redskabsrum" str. "230"; gælder også for størrelse "90" & "150". Ved flere punkter af opsætningen er yderligere hjælp påkrævet af 1 person.*

! Um Kratzer zu vermeiden, verwenden Sie bitte geeignete Unterlagen!

- (GB) *Please use a suitable underlay to avoid scratches!*
- (FR) *Pour éviter les rayures, utilisez les supports appropriés!*
- (NL) *Om krassen te voorkomen raden wij u aan er iets onder te leggen!*
- (ES) *Por favor, coloque en el suelo una base protectora adecuada para evitar posibles arañazos.*
- (IT) *Utilizzare una base adatta per evitare graffi!*
- (DK) *Benyt venligst et passende underlag for at undgå skrammer!*

! Schraubverbindungen grundsätzlich erst am Ende der Montage festziehen!

- (GB) *Nuts not to be tightened before the end of assembly!*
- (FR) *Ne serrer les écrous à fond qu'à la fin du montage!*
- (NL) *Schroeven pas aan het einde van de montage vastdraaien!*
- (ES) *En principio, no apriete fijamente las tuercas hasta que no haya terminado de montar la caseta.*
- (IT) *I dadi devono essere serrati a fondo soltanto alla fine del montaggio!*
- (DK) *Møtrikkerne må ikke strammes før slutningen af opsætningen!*

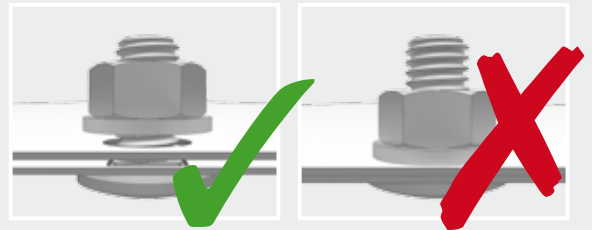

! Nicht bei Wind aufbauen!

- (GB) *Do not assemble the shed on a windy day!*
- (FR) *Ne pas assembler quand il y a du vent !*
- (NL) *Niet bij wind opbouwen!*
- (ES) *!No montar con ráfagas de viento!*
- (IT) *Non costruire nel vento!*
- (DK) *Saml ikke skuret på en blæsende dag!*



! Verwenden Sie bei der Montage Arbeitshandschuhe!

- (GB) *Wear working gloves!*
- (FR) *Portez des gants de travail*
- (NL) *Handschoenen gebruiken!*
- (ES) *Utilice unos guantes de trabajo.*
- (IT) *Utilizzare guanti da lavoro*
- (DK) *Brug arbejdshandsker!*



! Nagel - Symbol:

Bitte verwenden Sie den beiliegenden Nagel, um die Löcher der einzelnen Bleche auszurichten.

- (GB) *Symbol of nail: Please use the attached nail to align the holes of each sheet.*
- (FR) *Symbole clou : veuillez utiliser le clou fourni pour aligner les trous sur chaque paroi.*
- (NL) *Spijker-symbool: Bij montagestappen waar dit symbool bijstaat dient de spijker voor het laten corresponderen van 2 schroefgaatjes.*
- (ES) *Símbolo del clavo: Utilice los clavos suministrados para alinear los orificios de cada chapa.*
- (IT) *Simbolo del chiodo: Si prega di utilizzare il chiodo incluso per allineare i buchi di ogni lamiera.*
- (DK) *Søm-symbol: Brug de medfølgende søm til at rette hullerne på de enkelte plader ind*





Optionales Zubehör - Symbol:

Arbeitsschritte die blau eingrahmt sind, zeigen den Einbau eines optionalen Zubehörteiles.

- (GB) *Symbol of optional accessories: Blue framed assembly steps show the installation of optional accessories.*
- (FR) *Accessoires en option-Symbole: La trame entourée en bleu indique une étape avec accessoires en option. A réaliser uniquement si vous avez commandé cet accessoire.*
- (NL) *Extra Toebehoor: Montageschappen met een blauwe rand betreffen de inbouw van extra toebehoor.*
- (ES) *Accesorio opcional - símbolo: Los pasos de montaje que se encuentran enmarcados en azul muestran el montaje de una pieza de un accesorio opcional.*
- (IT) *Simbolo per accessori opzionali: Le fasi del montaggio incorniciate in colore azzurro mostrano l'installazione di un accessorio opzionale.*
- (DK) *Symbol for ekstra udstyr: Blåt indrammet samletrin viser installationen af ekstraudstyr*



optionales Zubehör - Accesso...

Bodenrahmen

Floor Frame - Cadre de sol



Wasserwaagen - Symbol:

Betreffendes Einbauteil mit der Wasserwaage ausrichten.

- (GB) *Symbol of spirit level: Align the respective parts by using the spirit level.*
- (FR) *Symbole niveau à bulle: Lorsque ce symbole apparaît, vous devez ajuster l'élément à l'aide d'un niveau à bulle.*
- (NL) *Waterpas - symbol: Bij montageschappen waar dit symbool bijstaat is het noodzakelijk het betreffende onderdeel waterpas in te bouwen.*
- (ES) *Símbolo del nivelador: Indica que se debe ajustar y centrar la pieza con la ayuda de un nivelador.*
- (IT) *Simbolo di livella a bolla d'aria: Allineare il componente in questione con l'ausilio di una livella a bolla d'aria.*
- (DK) *Symbol for vaterpas: Juster de respektive dele ved hjælp af vaterpas.*

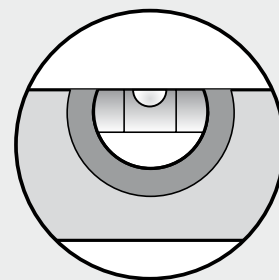

Größenabhängiger Montageschritt!

- (GB) *Size-Dependent assembly step!*
- (FR) *Dépendant de la taille assemblage étape!*
- (NL) *Size-Dependent montageschappen!*
- (ES) *Paso de montaje de tamaño Dependiente!*
- (IT) *Taglia-Dependent fase di montaggio!*
- (DK) *Størrelses-afhængig montage skridt*



Größenabhängiger Montageschritt

Nur für Größe 150

(Only for size 150 - Uniquement)



Montageschritt entfällt - Symbol:

Arbeitsschritt entfällt bei der im Symbol genannten Größe.

- (GB) *Symbol of assembly step not applicable: Assembly step is not applicable for the mentioned size in the symbol.*
- (FR) *Étape de montage à supprimer - Symbole: Cette étape est supprimée selon la taille indiquée dans le symbole.*
- (NL) *Montageschappen vervalt - symbol: Montageschappen vervalt bij de in het symbool genoemde grootte. onderdeel waterpas in te bouwen.*
- (ES) *Paso de montaje eliminado - Símbolo: Paso de trabajo eliminado en el tamaño indicado en el símbolo.*
- (IT) *Questa fase di montaggio viene annullata - simbolo: Questa fase di lavoro viene annullata nella misura indicata con il simbolo.*
- (DK) *Monteringskridtet ikke nødvendigt - symbolet: For arbejdsgangen falder bort for den størrelse, der vises med symbolet.*



90

Maßstabsgetreue Abbildungen der zu verwendenden Schrauben:

- (GB) *Scale drawing 1:1 of the screws in use*
- (FR) *Reproduction selon l'échelle 1:1.*
- (NL) *Afbeelding : schaal 1:1 (ware grootte)*
- (ES) *Reproducción a escala 1:1 de los tornillos que se utilizan para el montaje.*
- (IT) *Immagine in scala delle viti da utilizzare!*
- (DK) *Skala tegning af skruer er 1:1*

M 1:1

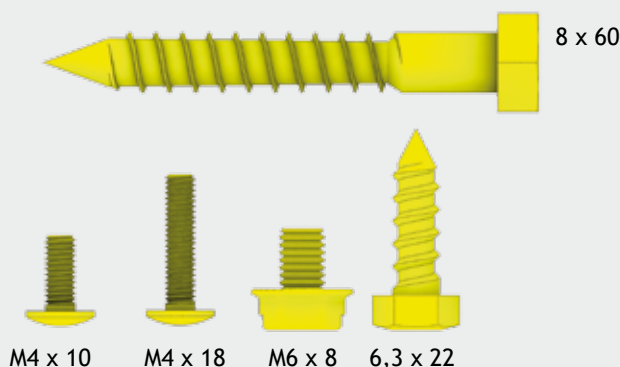

Pflege und Wartung

- Keine aggressiven Chemikalien wie z.B. Chlor oder Streusalz lagern!
- Sonnenmilch und andere Cremes mit Wasser und Seife entfernen
- Keine scheuernden Reinigungsmittel verwenden!
- Tiefe Kratzer sofort mit beiliegendem Lack ausbessern!
- Ölen Sie das Schloss jährlich!

NL Onderhoud

- Geen chemicaliën om de berging opslaan
- Zonnebrandolie/melk en andere cremes met water en glansmiddel verwijderen
- Gebruik geen schuurmiddelen!
- Krassen direct met de meegeleverde lak behandelen
- Slot jaarlijks oliën

DK Pleje og vedligeholdelse

- Opbevar ikke aggressive stoffer dvs. Klor eller vejsalt!
- Fjern solcreme eller andre typer af creme med vand og rensmiddel!
- Brug ikke aggressive rengøringsmidler!
- Ved skrammer, brug straks malingen som er stillet til rådighed!
- Smør låsen årligt!

EN Care and maintenance

- Do not store aggressive substances i.e. chlorine or road salt
- Remove suntan lotion or any other creams with water and rinse aid!
- Do not use abrasive cleaning agents!
- Touch-up scratches immediately with the paint provided.
- Lubricate the lock once a year!

ES Cuidado y mantenimiento

- No almacene productos químicos agresivos dentro de la caseta como por ejemplo cloro y sal antiescarcha.
- Evite dejar huellas o restos de cremas solares sobre la chapa. Limpie la caseta siempre con agua o un trapo húmedo.
- Repare los arañazos lo antes posible con el barniz que se incluye
- Aplique aceite en la cerradura y las bisagras una vez al año

FR Entretien et maintenance

- Ne pas stocker de produits chimiques (chlore, sel, etc...)
- Nettoyez uniquement avec de l'eau les crèmes solaires et autres crèmes (pas de nettoyeur chimique).
- Corrigez immédiatement les rayures avec la laque jointe!
- Graissez la serrure et les charnières chaque année !

IT Manutenzione

- Non lasciare prodotti chimici aggressivi (come ad esempio cloro o sale per strade) all'interno della casetta!
- Rimuovere crema solare e altre creme con acqua e brillantante!
- Ritoccare immediatamente eventuali graffi con la vernice fornita nella confezione!
- Lubrificare la serratura e le cerniere a cadenza annuale!

Vorschläge für das Fundament

Bitte achten Sie bei der Fundamentgestaltung darauf, dass Niederschlagswasser nicht seitlich unter den Bodenprofilen in das Gerätehaus eindringen kann! (siehe Varianten 1, 2, 3). Aufsteigende Bodenfeuchtigkeit und Kondensation vermeiden Sie mittels einer starken Kunststoffolie unter dem Fundament.

GB Proposals for a secure foundation

When making the foundation arrangements please take necessary precaution to ensure that water cannot leak in under the floor profiles (see option 1, 2, 3). Rising ground moisture and condensation can be avoided by using a strong plastic sheet underneath the paving slabs or underneath the concrete foundation.

FR Conseils pour les fondations

Lors de la réalisation de la fondation, veillez à ce que l'eau de pluie ne puisse pas pénétrer dans l'abri ou par les côtés sous les profils de sol (voir variantes 1,2,3). Vous pouvez éviter l'humidité du sol et la condensation en mettant un film plastique épais sous les plaques de béton.

NL Voorstellen voor fundament

Let er bij het maken van de fundering op dat regenwater niet onder het bodemprofiel kan doorlopen (zie voorbeeld 1,2,3). Een vochtige bodem en condensatie kunt u vermijden door het aanbrengen van een sterke kunststoffolie onder de tegels of het betonfundament.

ES Medidas y recomendaciones para los cimientos:

Al colocar los cimientos, asegúrese de que el agua de lluvia no puede penetrar en la caseta por los laterales debajo del perfil del suelo (véase variante 1,2 y 3). Evite la humedad y la condensación en el suelo colocando una lámina de plástico bajo las losas o los cimientos de hormigón.

IT Proposte per il basamento:

Il basamento deve essere progettato in modo da evitare infiltrazioni di acqua piovana all'interno della casetta (vedere proposta 1-2-3). Un telo di plastica spesso posto in corrispondenza dell'area di pavimento evita infiltrazioni di umidità dal terreno e la formazione di condensa.

DK Forslag til sikkert fundament:

Ved etablering af fundament skal du tage de nødvendige forholdsregler for at sikre, at vand ikke kan sive ind under gulvprofilerne (se mulighed 1, 2, 3). Stigende fugt og kondens i jorden kan undgås ved at bruge plastik under flisebelægningen eller under betonfundamentet.



Weitere Details betreffend Fundament finden Sie auch unter www.biohort.com/Fundament

Further details about foundations you will find on www.biohort.com/foundation

Pour des détails supplémentaires, veuillez consulter www.biohort.com/foundations

Verdere details over het fundament vindt u ook op www.biohort.com/fundament

Encuentre información detallada sobre los cimientos en: www.biohort.com > servicios > cimientos

Per ulteriori dettagli si prega di consultare www.biohort.com/it/servizi/suggerimenti-per-le-fondamenta/

Yderligere informationer om fundamentet finder du på www.biohort.com/foundation

Maße für das Fundament

- Ⓒ GB Foundation dimensions
- Ⓒ FR Dimensions pour la fondation
- Ⓒ NL Maat voor het fundament

- Ⓒ ES Medidas de los cimientos
- Ⓒ IT Dimensioni del basamento
- Ⓒ DK Fundament dimensioner

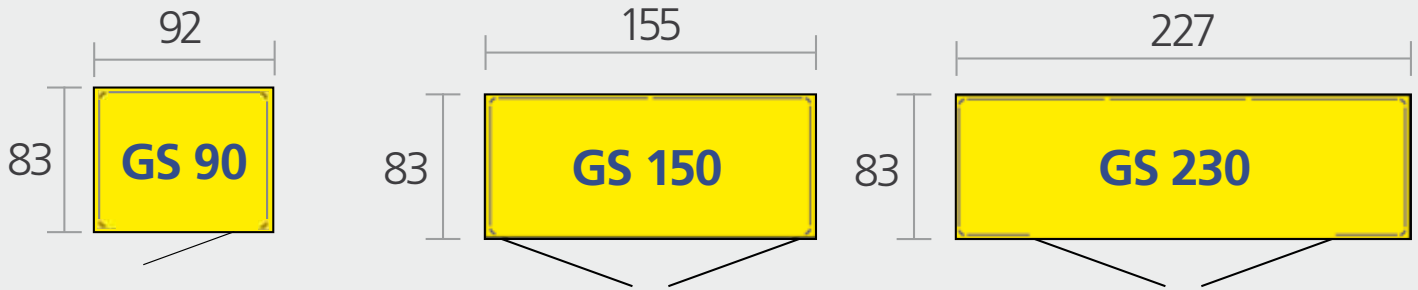

ACHTUNG ATTENTION
ATTENTION | ATTENTIE |
ATENCIÓN | ATENZIONE |
OBS.



Die Verankerung ist wichtig, denken Sie an Sturmböen!

Do not forget to anchor the shed against gale force wind!

L'ancrage est important, pensez aux rafales de vent!

Verankering niet vergeten!

El anclaje es muy importante. Piense por ejemplo en rachas fuertes de viento.

L'ancoraggio della casetta è importante - pericolo in caso di raffiche di vento!

Glem ikke at forankre skuret mod vinde af stormstyrke

Variante, Proposal, Variant 1

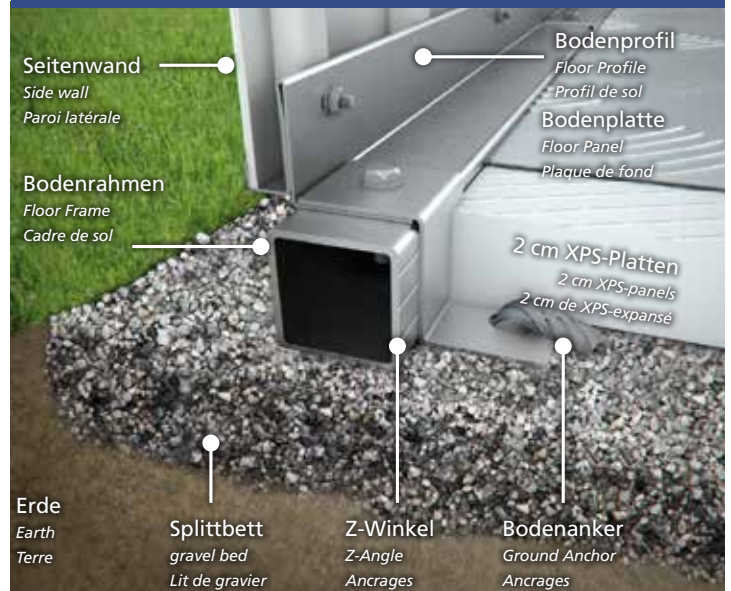

Variante, Proposal, Variant 2

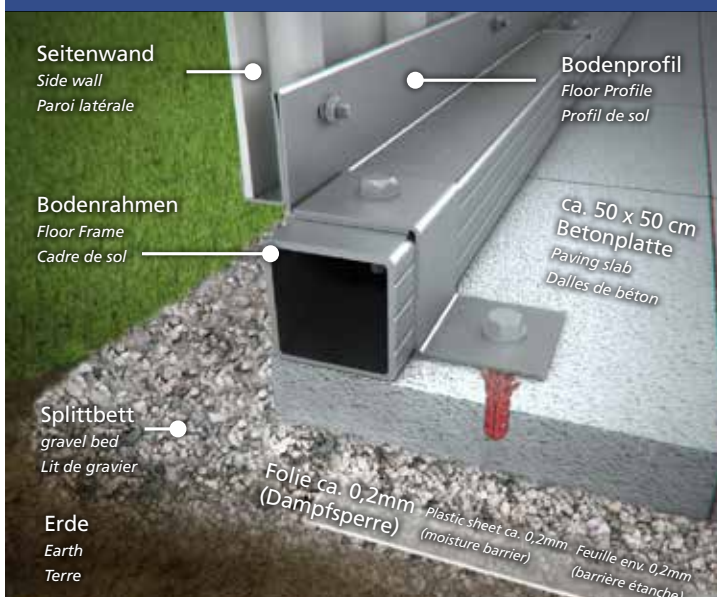

Variante, Proposal, Variant 3

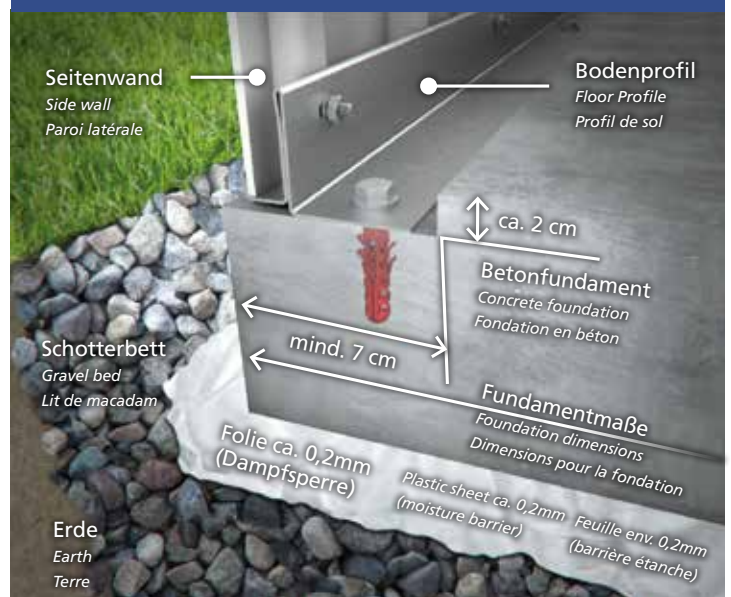

Teileübersicht Geräteschrank 90

parts list · liste des pièces · stuklijst · lista de piezas · lista de parti · deloversigt

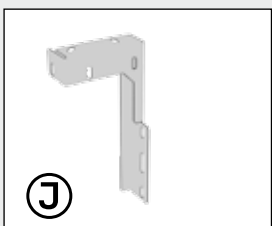
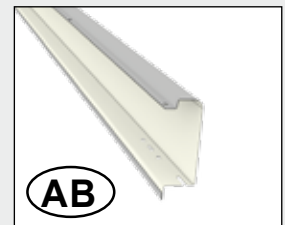
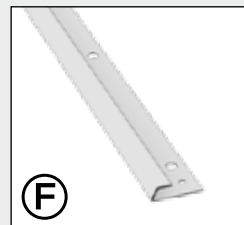
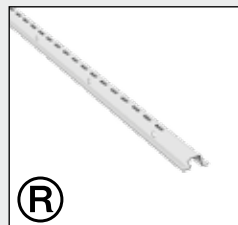
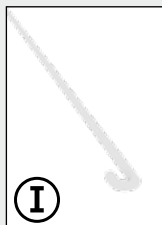
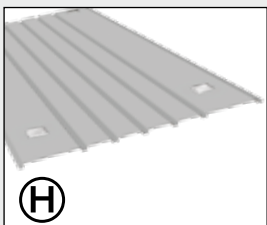
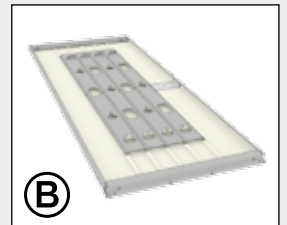
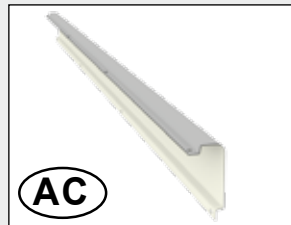
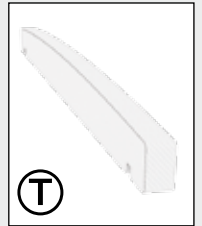
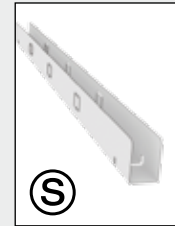
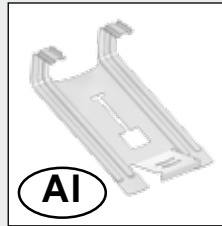
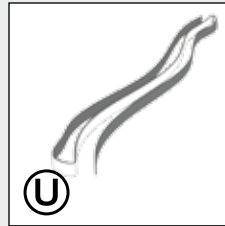
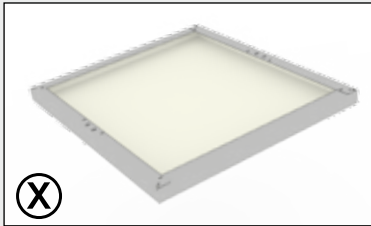
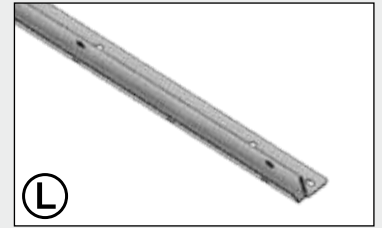
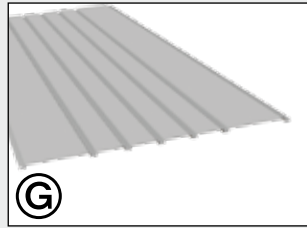
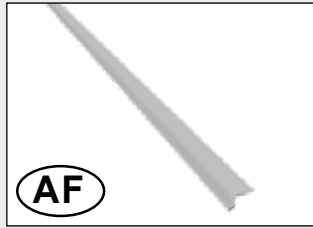
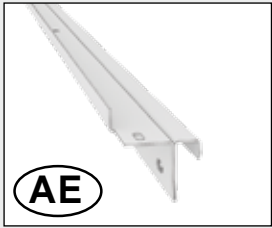

Teileübersicht Geräteschrank 150,230

parts list · liste des pièces · stuklijst · lista de piezas · lista de parti · deloversigt



1

Paket Nr. 1

Dach-Profilpaket · Top profile package · Carton de profils de toit · Dakprofielpakket · Kit de perfiles de tejado · Pacco profili del tetto · Tagprofilpakke

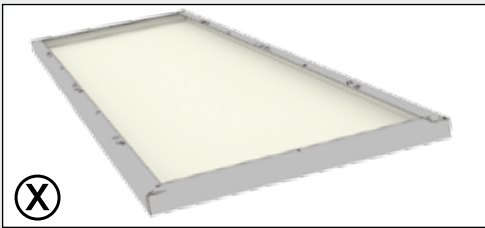
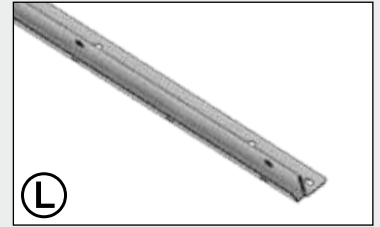
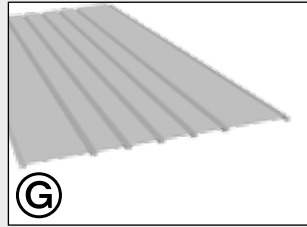
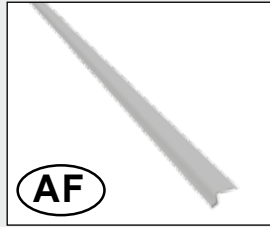
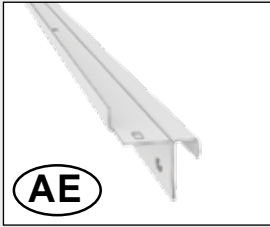

Nur für Größe 230
 Only for size 230
 Uniquement pour taille 230
 Alleen voor maat 230
 Sólo para los tamaños 230
 Solo per misura 230
 Kun for størrelse 230

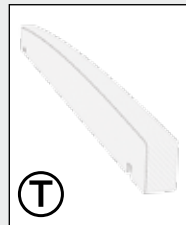
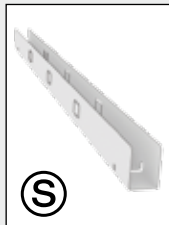
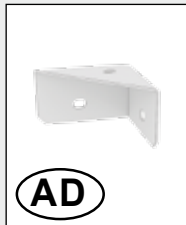
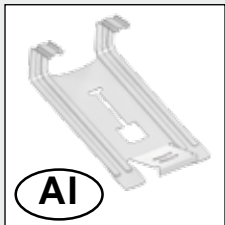
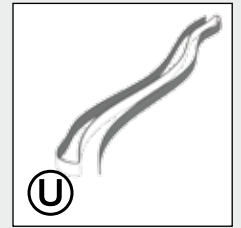
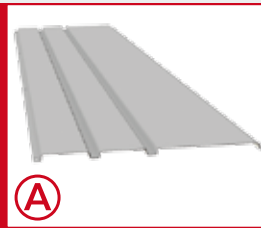

2

Paket Nr. 2

Korpus-Türpaket · Corpus-door package · Carton de l'ossature et la porte deur-corpus pakket · Paquete de la puerta y del corpus · Pacchetto di corpus e porta · Dørpakke kasse

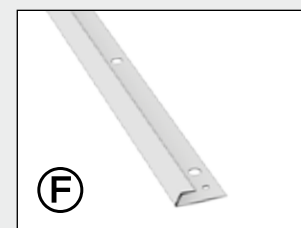
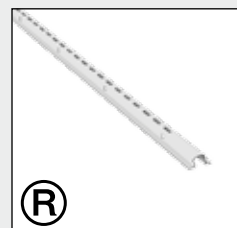
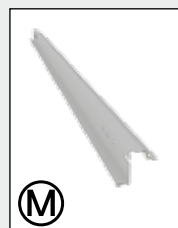
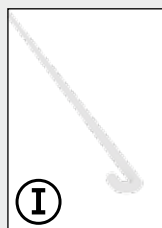
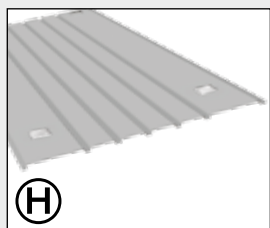
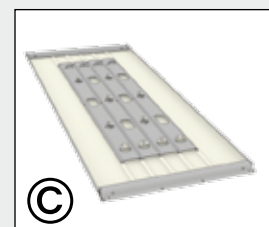
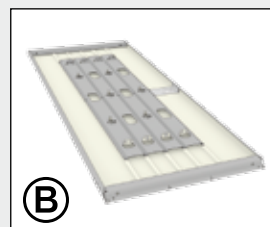
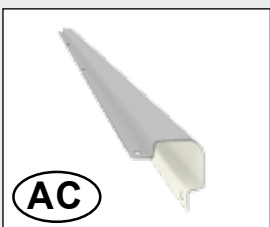

Bodenrahmen

Floor frame · Cadre de sol · Bodemframe · Marco de suelo · Telaio perimetrale · Bundramme

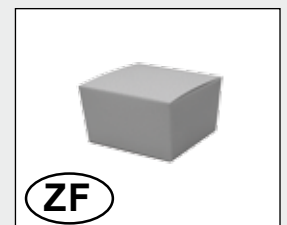
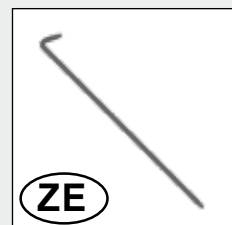
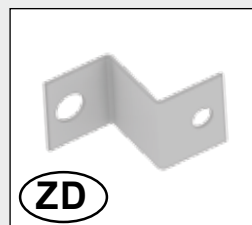
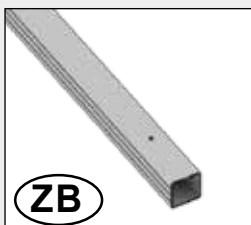

1.



L

GS 90: 2x L1 (770mm)
2x L2 (870mm)
GS 150: 2x L1 (770mm)
2x L2 (1490mm)
GS 230: 2x L1 (770mm)
2x L2 (2210mm)



J

GS 90: 1x



K

GS 90: 1x

M4 x 10



D2

GS 90: 10x
GS 150: 4x
GS 230: 4x

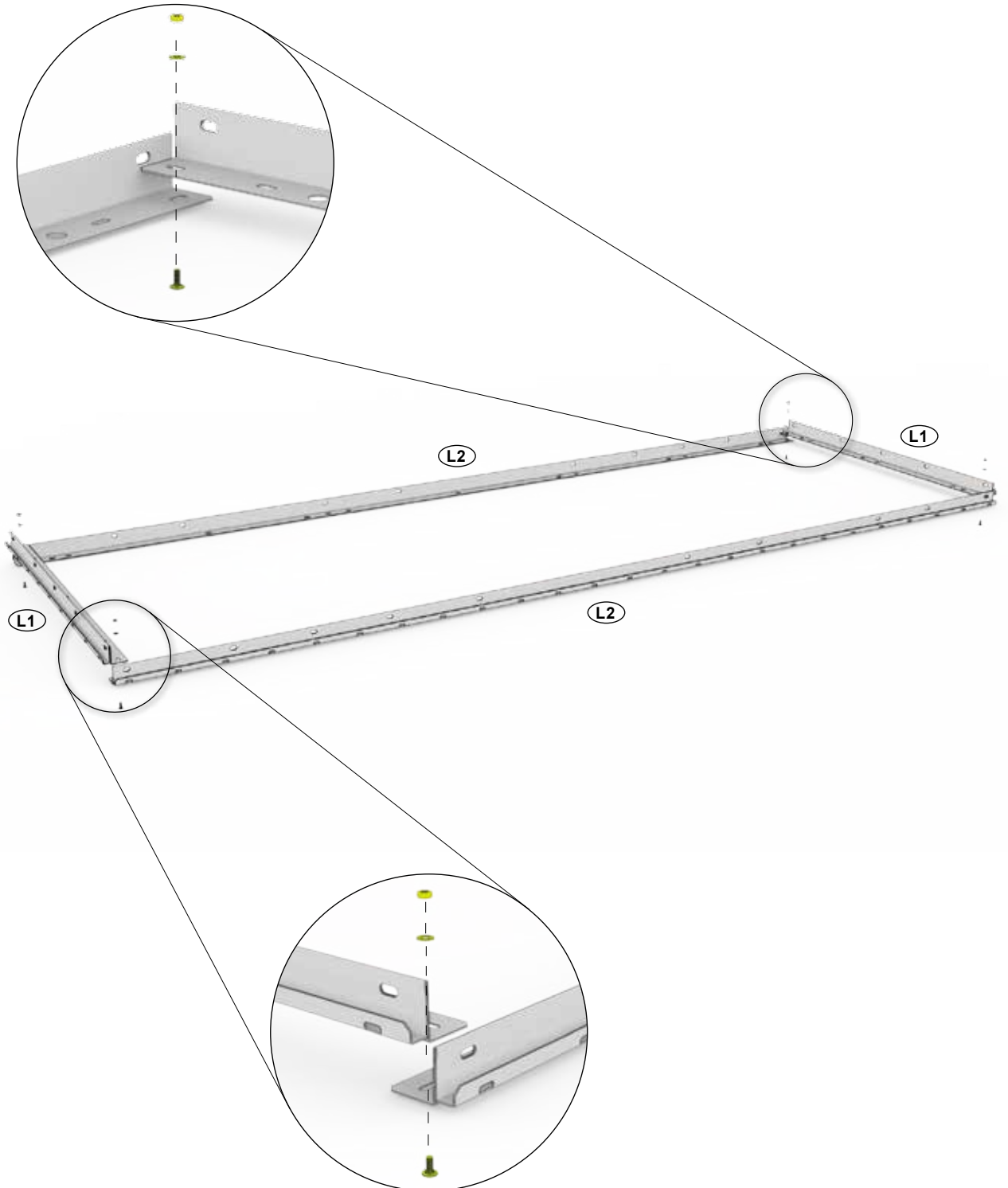



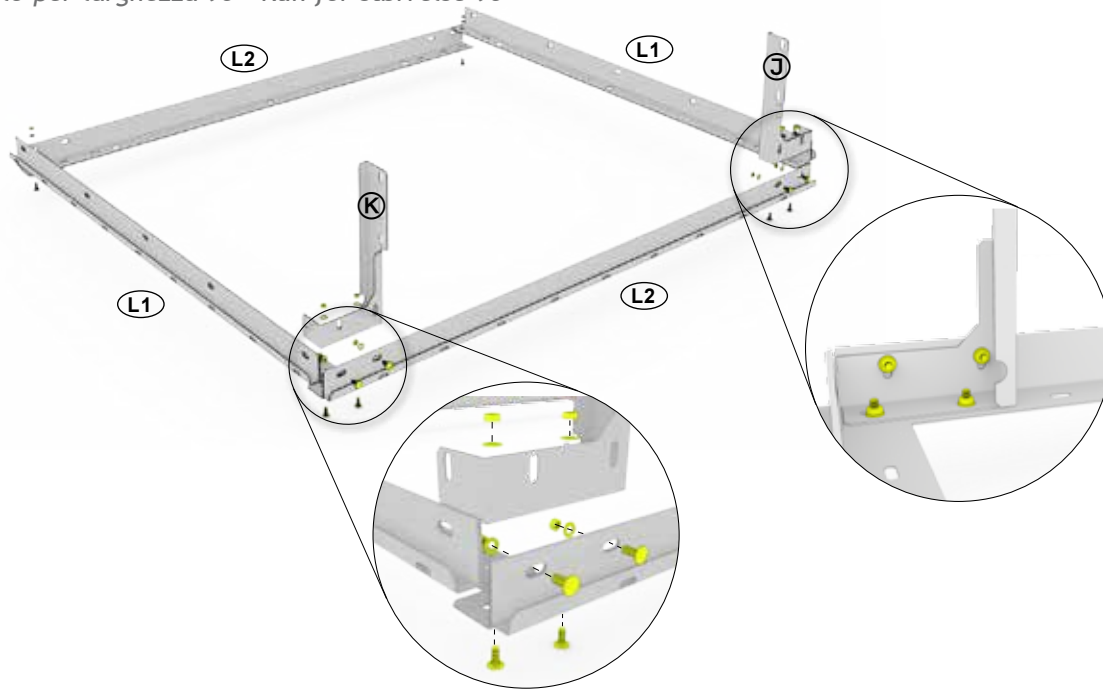

Nur für Größe 90

Only for width 90 · Juste pour la largeur de 90 · Alleen voor breedte 90 · sólo para el ancho de 90 · solo per larghezza 90 · Kun for størrelse 90



Paso de montaje de tamaño Dependiente - Taglia-Dependent fase di montaggio - Størrelses-anhængig montage skridt

2.

 F		GS 90: 1x (690mm)	M4 x 10 D2	GS 90: 2x
		GS 150: 1x (1380mm)		GS 150: 2x
		GS 230: 1x (1380mm)		GS 230: 2x

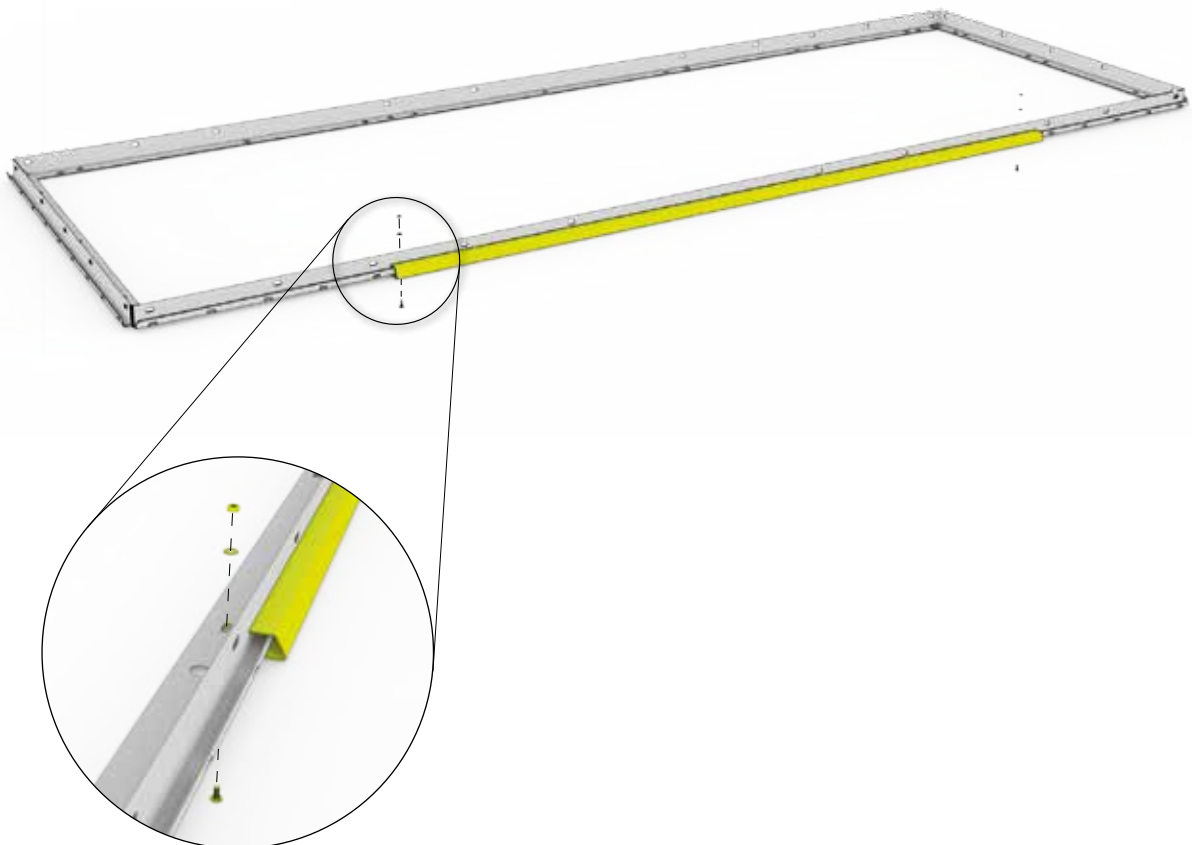

3.

2

GS 90: 1x



GS 150: 1x

GS 230: 1x

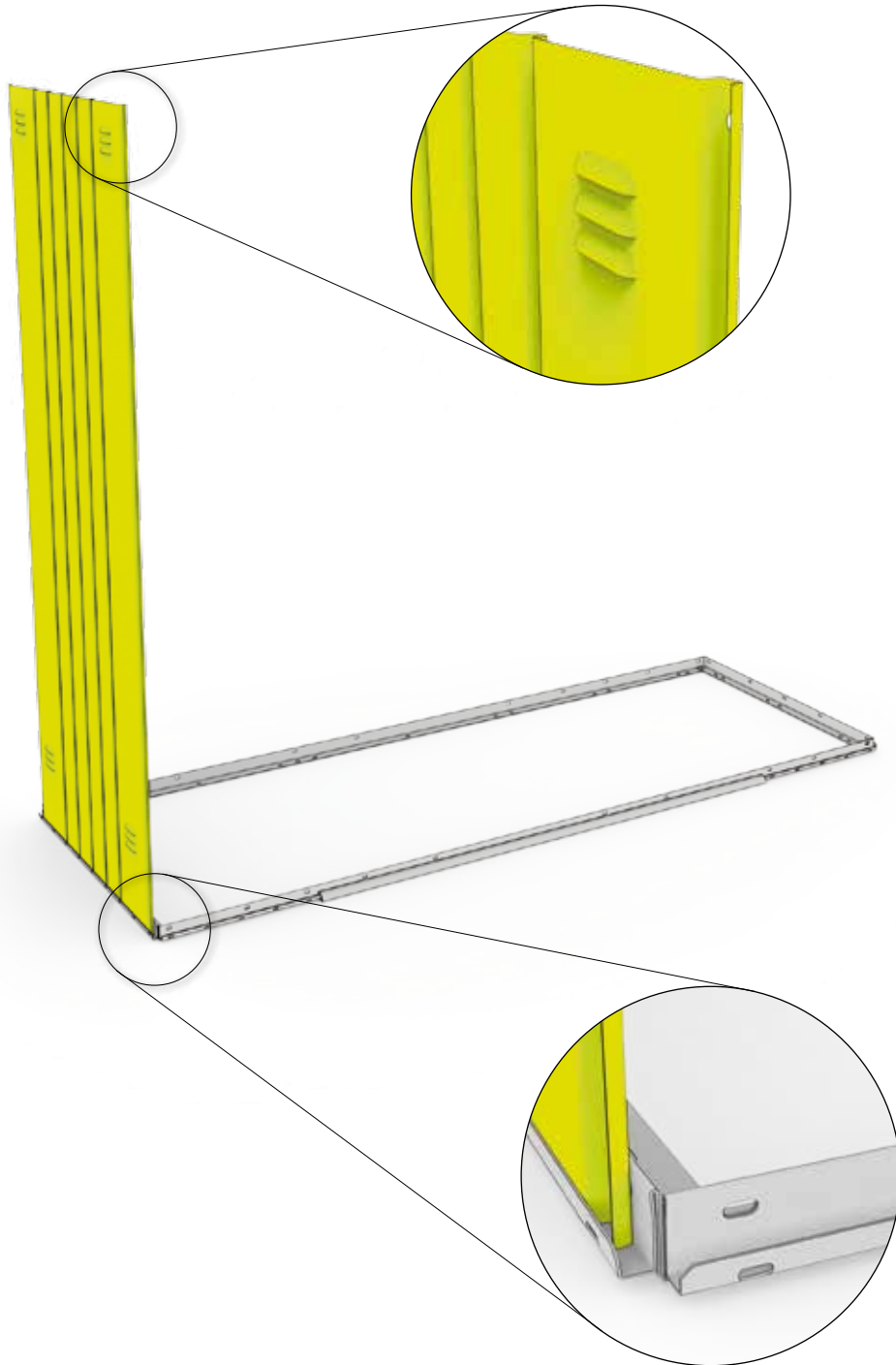
Ⓜ

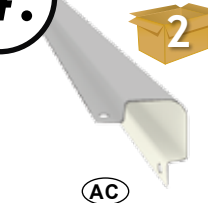

4.

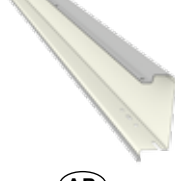
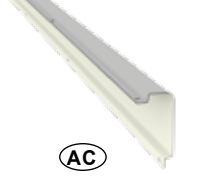
 GS 150: 2x GS 230: 2x (AC)	 M4 x 10 (D2)	GS 90: 6x GS 150: 6x GS 230: 6x	 (AB)	GS 90: 1x
 (AC)	GS 90: 1x			

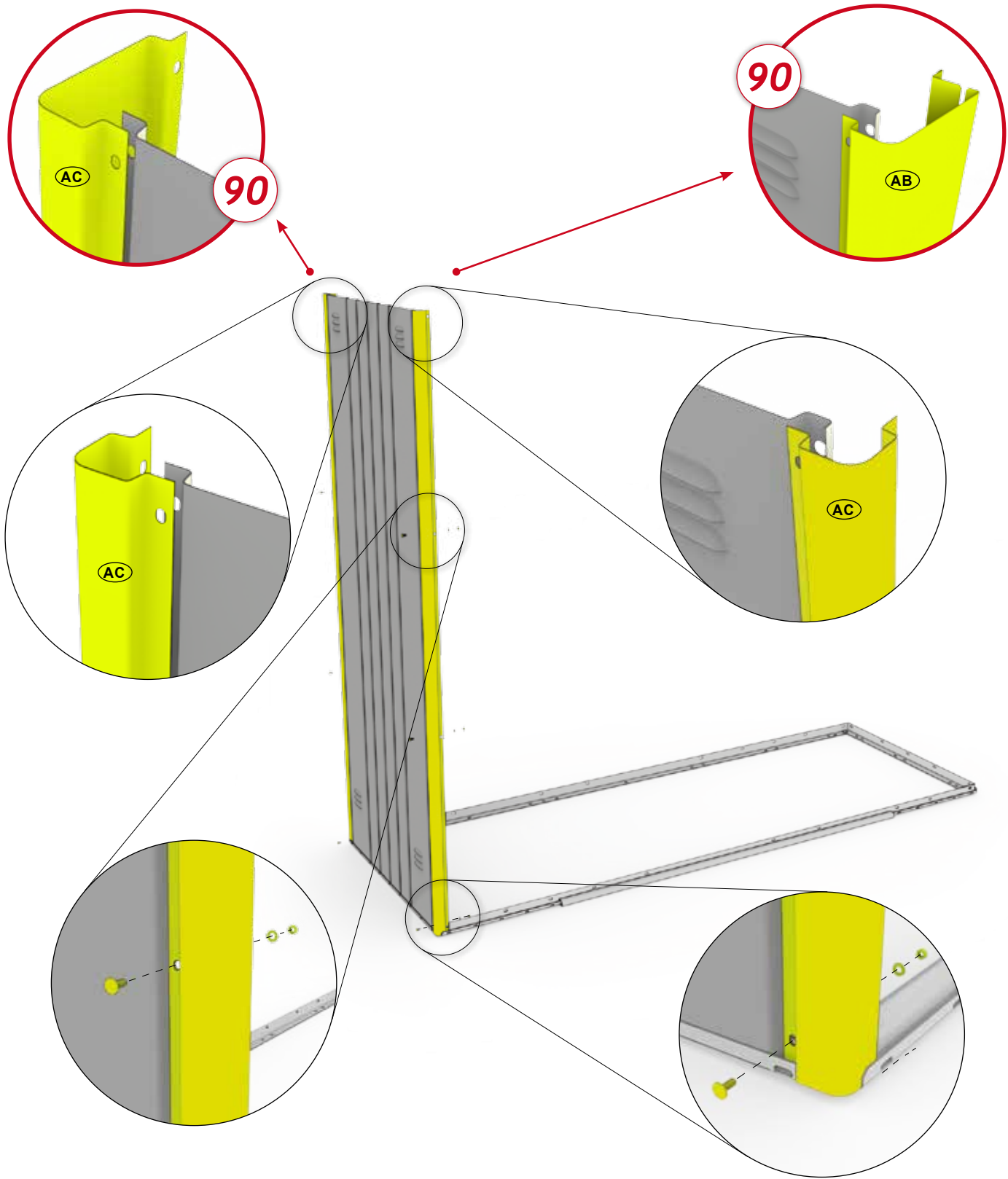

5.





GS 90: 1x
GS 150: 2x
GS 230: 3x

M4 x 10
D2

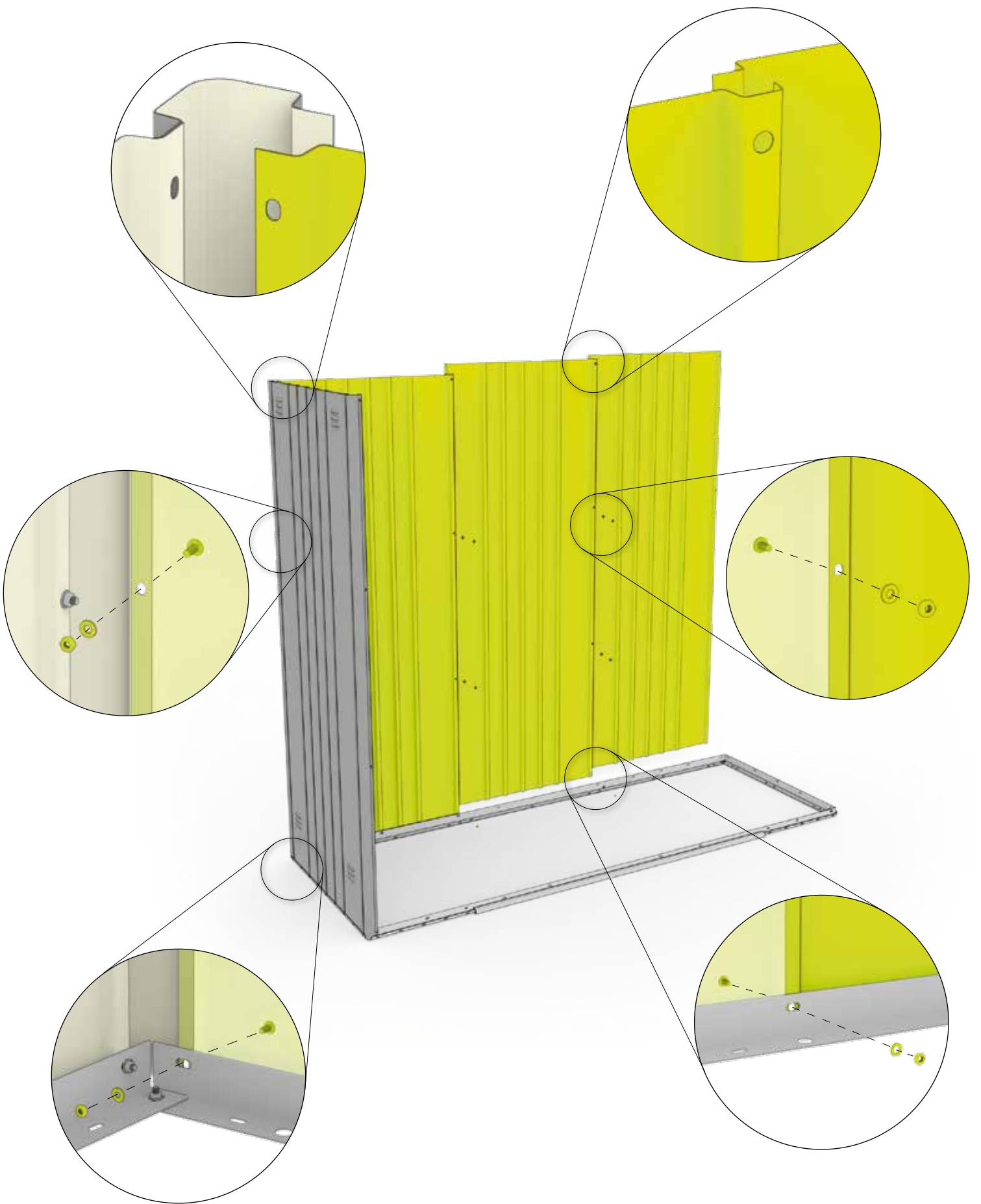
GS 90: 3x
GS 150: 6x
GS 230: 9x

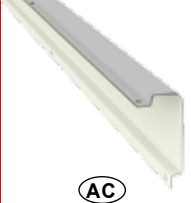

6.

  (AC)	GS 150: 1x GS 230: 1x	M4 x 10  (D2)	GS 90: 3x GS 150: 3x GS 230: 3x	 (AC)	GS 90: 1X
--	--------------------------	--	---------------------------------------	---	-----------

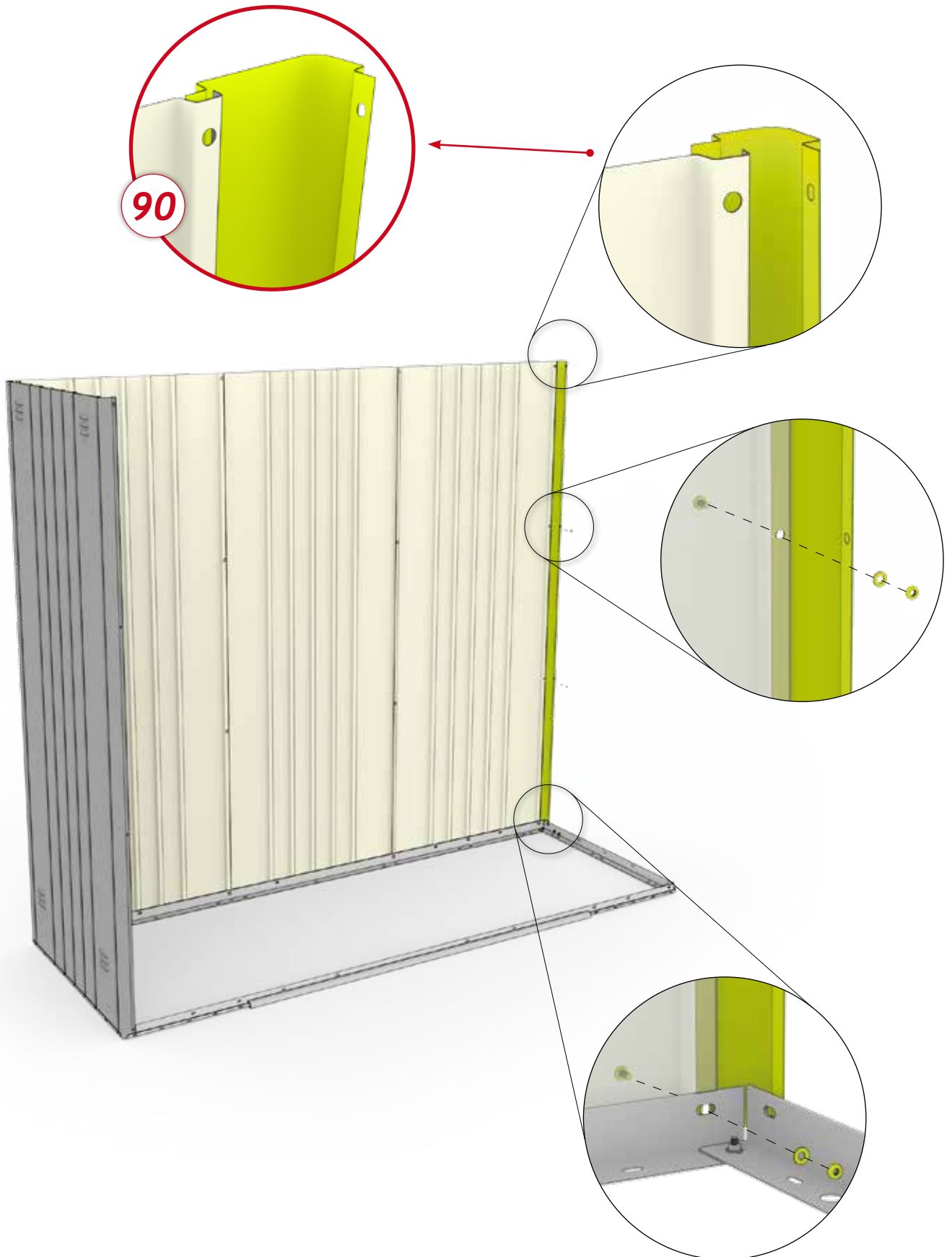

7.

2

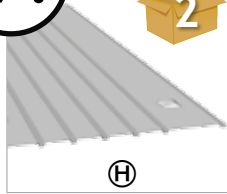

GS 90: 1x
GS 150: 1x
GS 230: 1x



M4 x 10

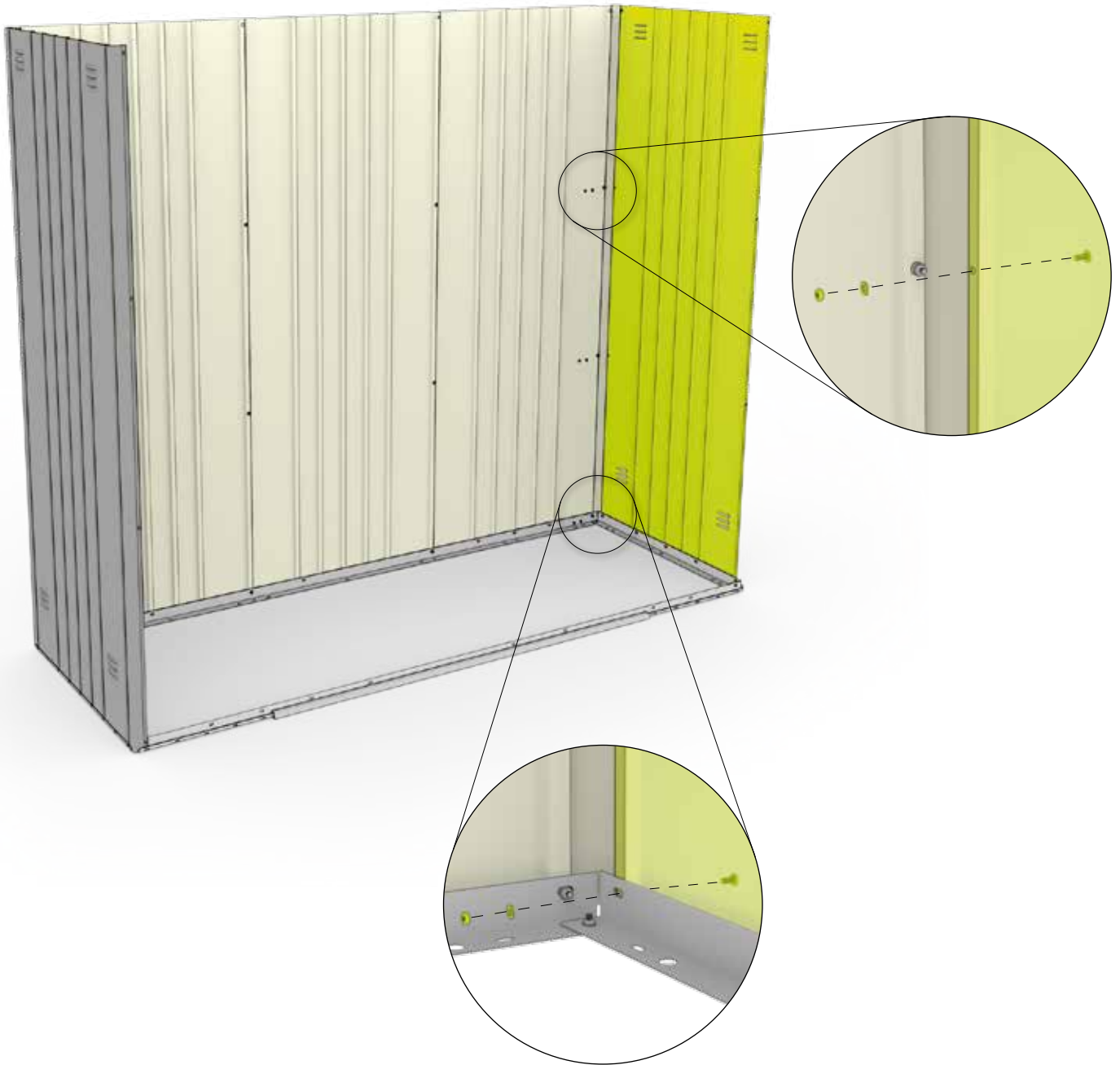

GS 90: 3x
GS 150: 3x
GS 230: 3x

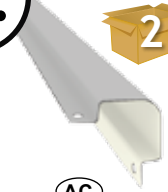

8.

 <p>AC</p>	<p>2</p> <p>GS 150: 1x GS 230: 1x</p>	<p>M4 x 10</p>  <p>D2</p>	<p>GS 90: 3x GS 150: 3x GS 230: 3x</p>	 <p>AB</p>	<p>GS 90: 1x</p>
---	---	--	--	---	------------------

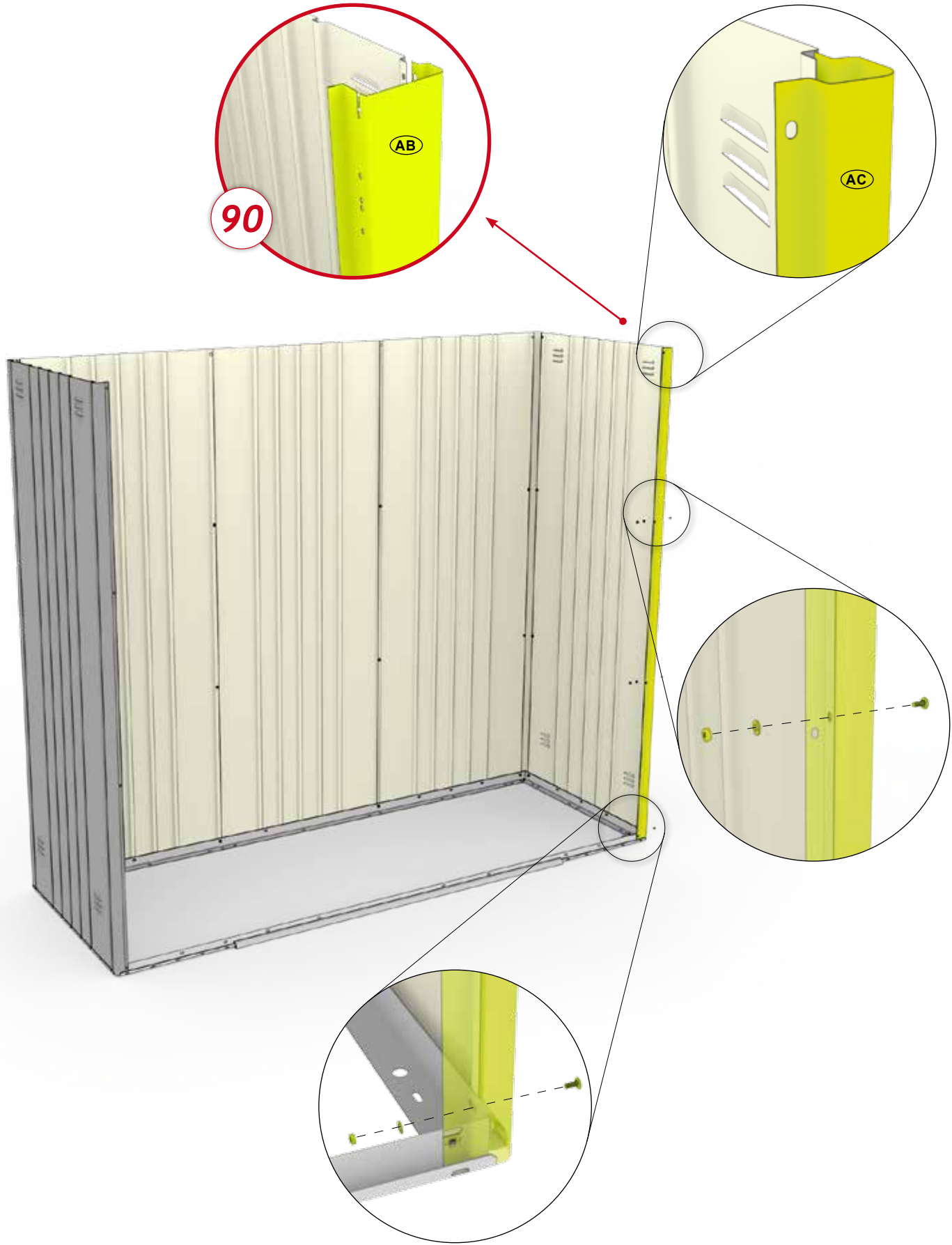

9.

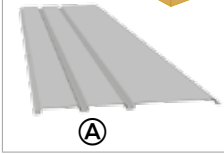

GS 230: 2x

M4 x 10



GS 230: 6x

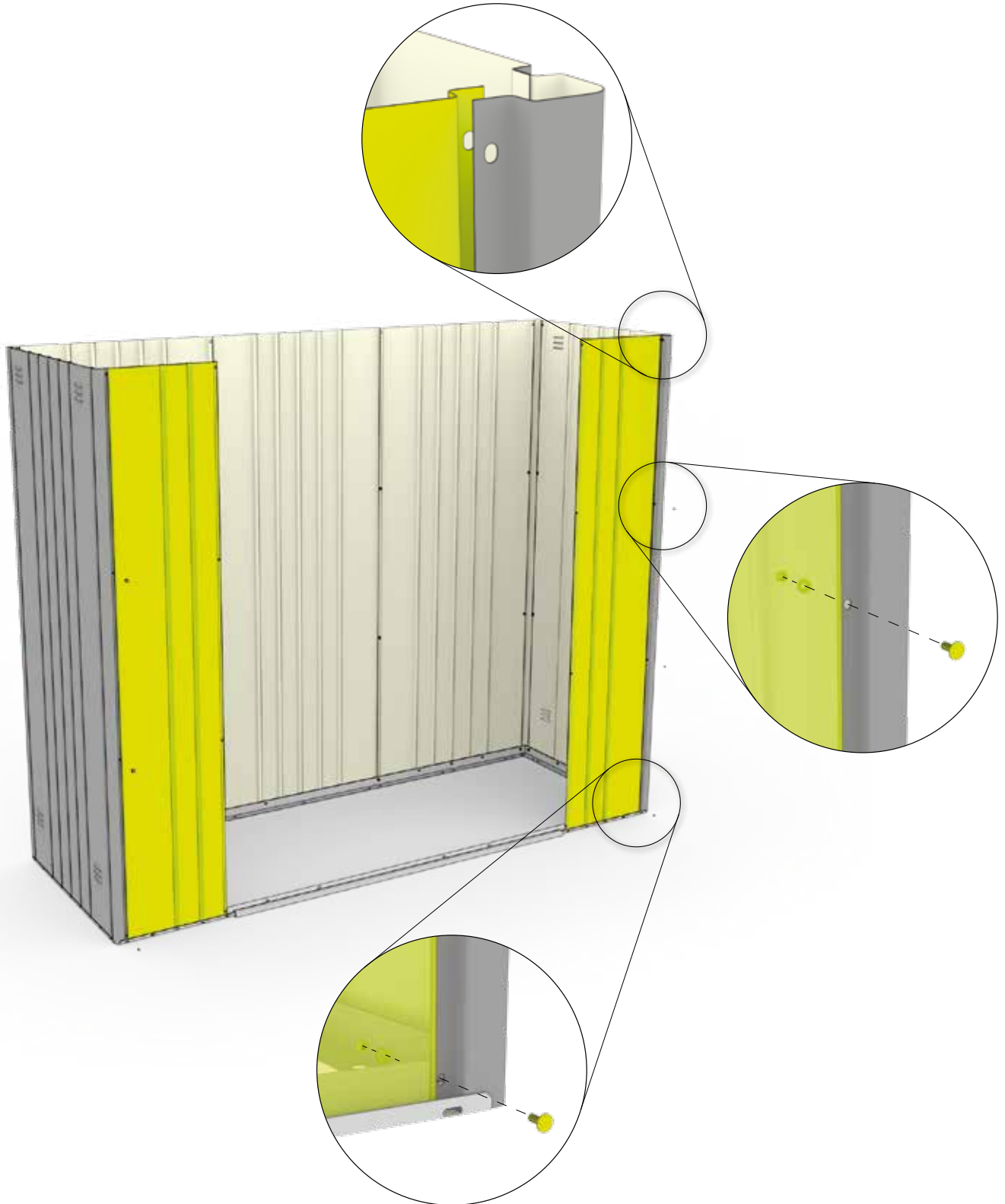

10.

2





GS 150: 2x
GS 230: 2x

M4 x 10
D2

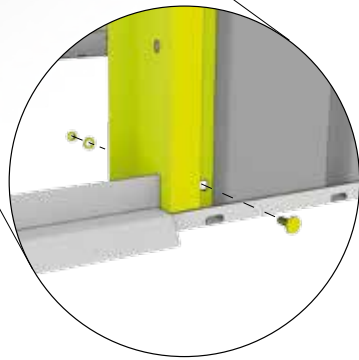
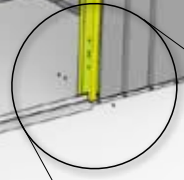
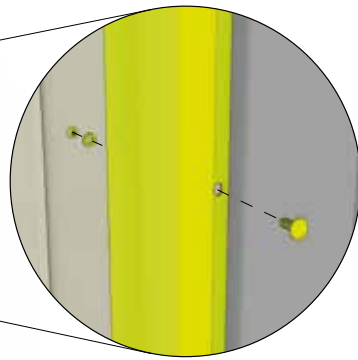
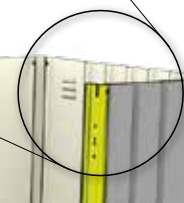
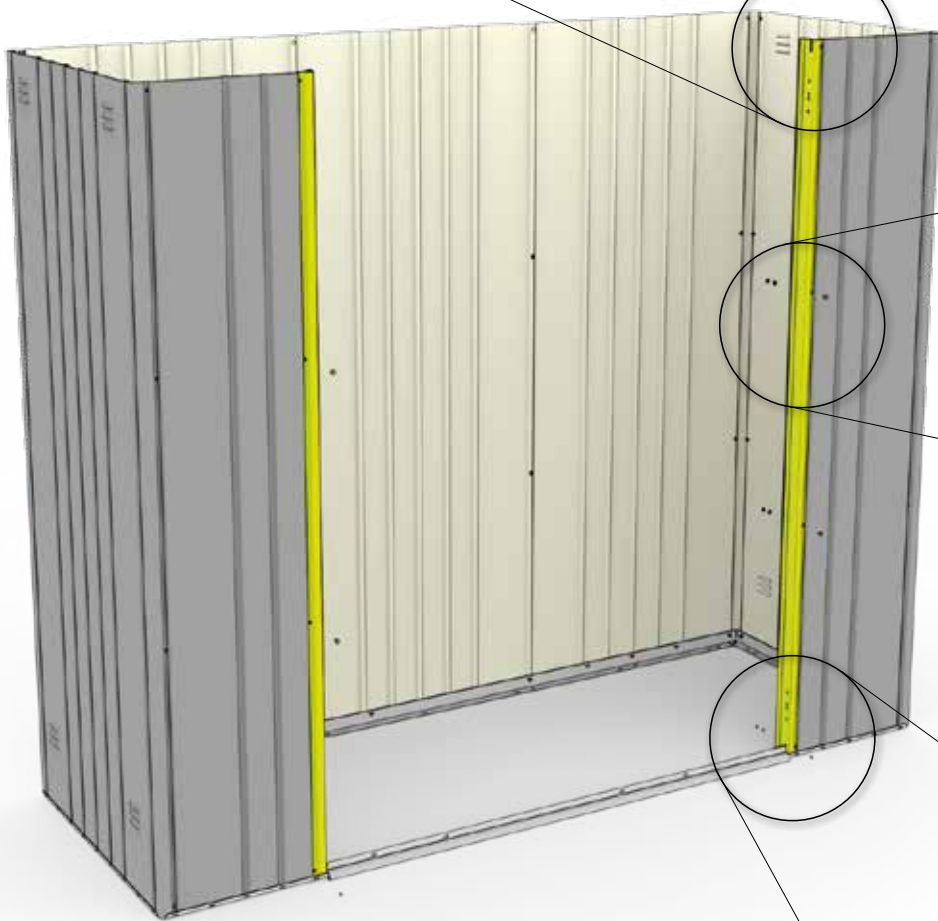
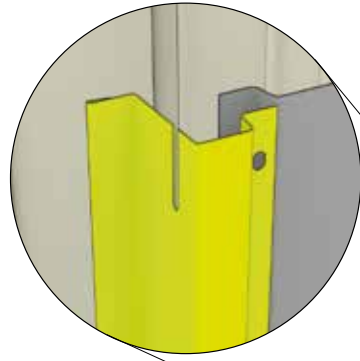
GS 150: 6x
GS 230: 6x

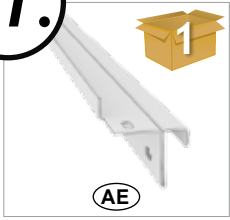

11.



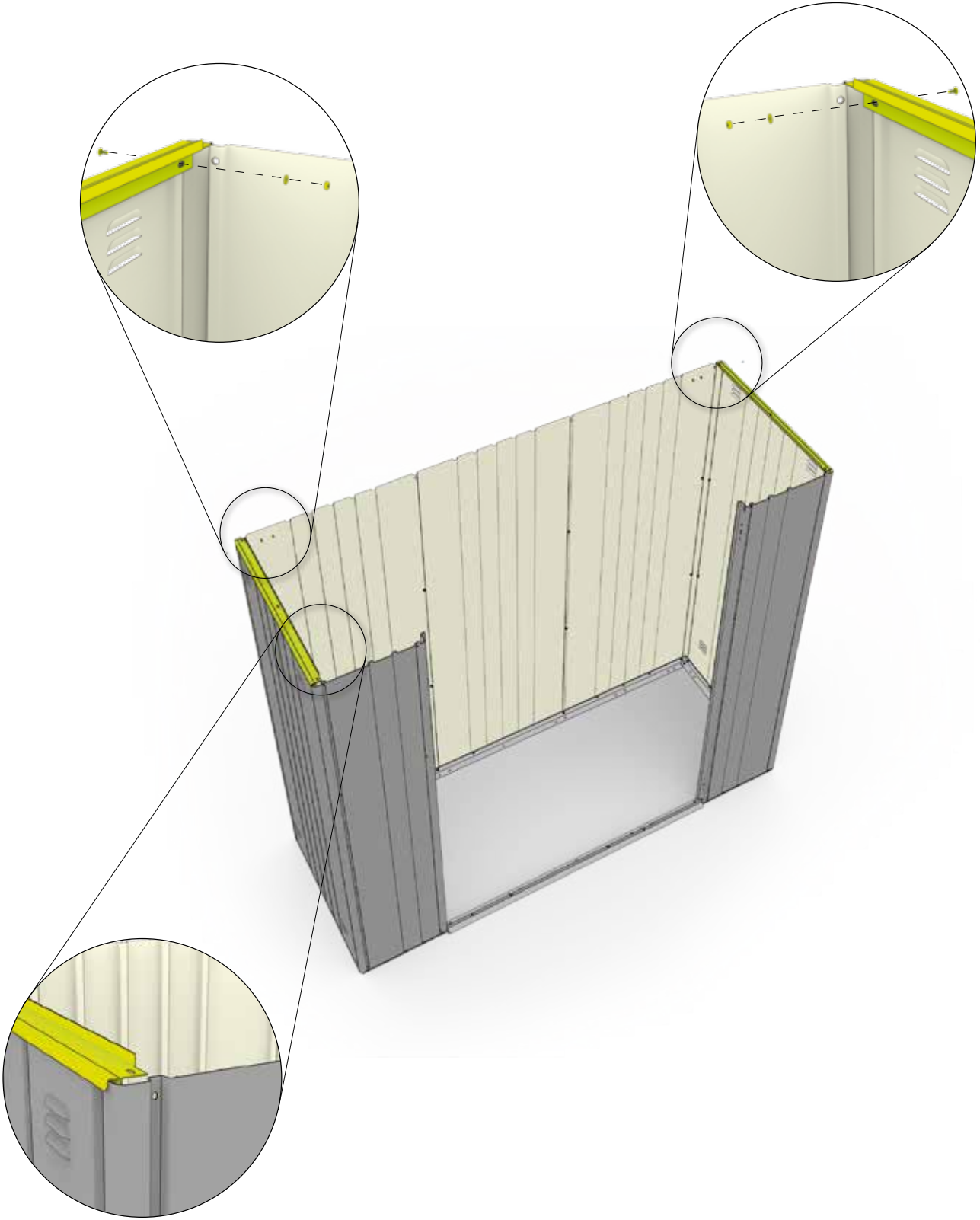





	GS 90: 2x (770mm) GS 150: 2x (770mm) GS 230: 2x (770mm)	M4 x 10  (D2)	GS 90: 2x GS 150: 2x GS 230: 2x
---	---	--	---------------------------------------











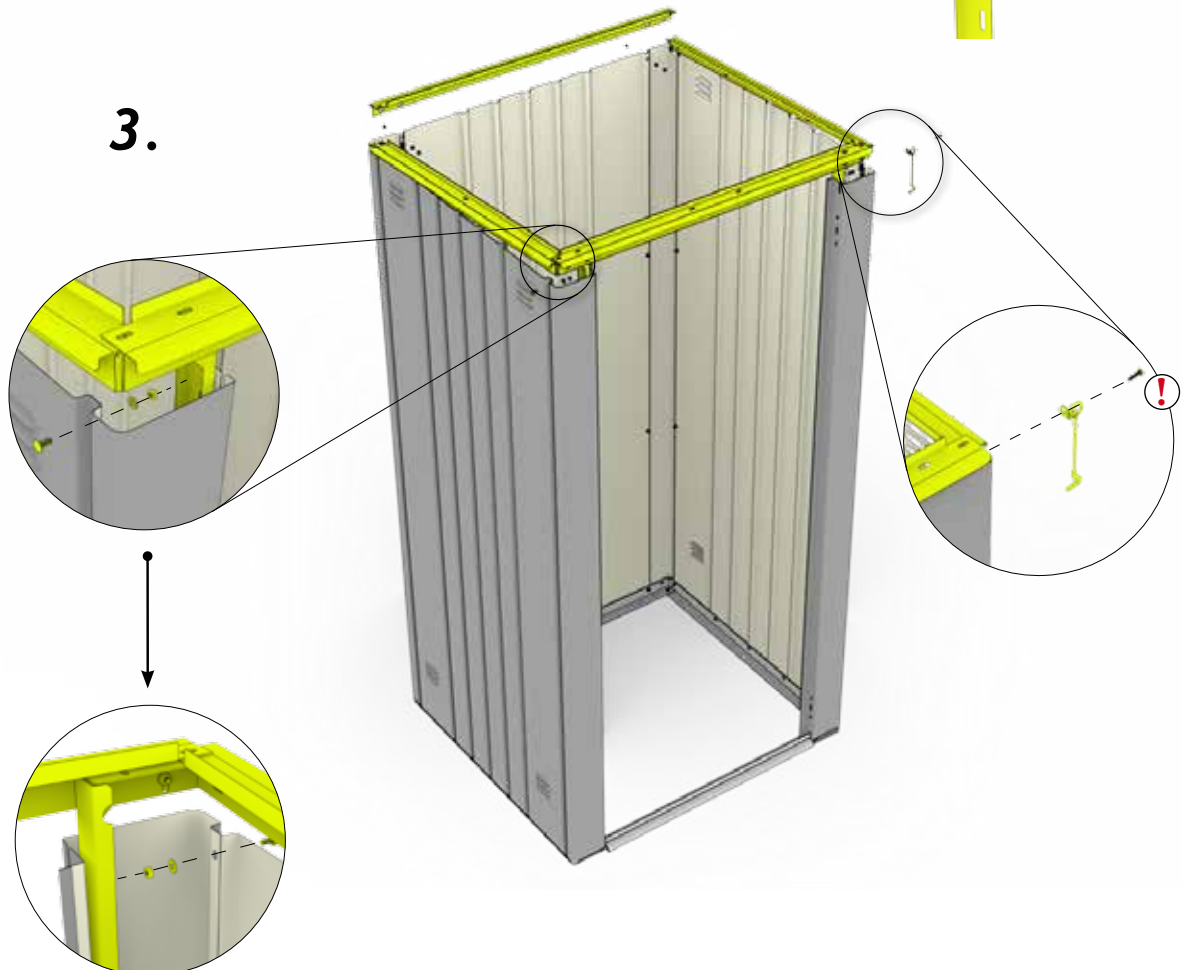
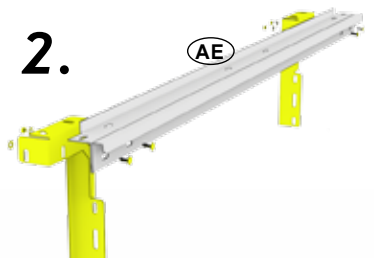

Nur für Größe 90

Only for width 90 · Juste pour la largeur de 90 · Alleen voor breedte 90 · sólo para el ancho de 90 · solo per larghezza 90 · Kun for størrelse 90

 J	GS 90: 1x	 K	GS 90: 1x	 AE	GS 90: 2x (870mm)
 D1	GS 90: 1x	 D1	GS 90: 1x	 D1	GS 90: 1x
 D2	GS 90: 1x	 D2	GS 90: 9x		



 <p>AE</p>	<p>GS 150: 2x (1490mm) GS 230: 2x (2210mm)</p>	 <p>AD</p>	<p>GS 150: 2x GS 230: 2x</p>	 <p>D1</p>	<p>GS 150: 2x GS 230: 2x</p>
 <p>D1</p>	<p>GS 150: 2x GS 230: 2x</p>	 <p>D1</p>	<p>GS 150: 2x GS 230: 2x</p>	<p>M4 x 10</p>  <p>D2</p>	<p>GS 150: 5x GS 230: 8x</p>
<p>M4 x 18</p>  <p>D2</p>	<p>GS 150: 2x GS 230: 2x</p>	 <p>90</p>			

1.



2.

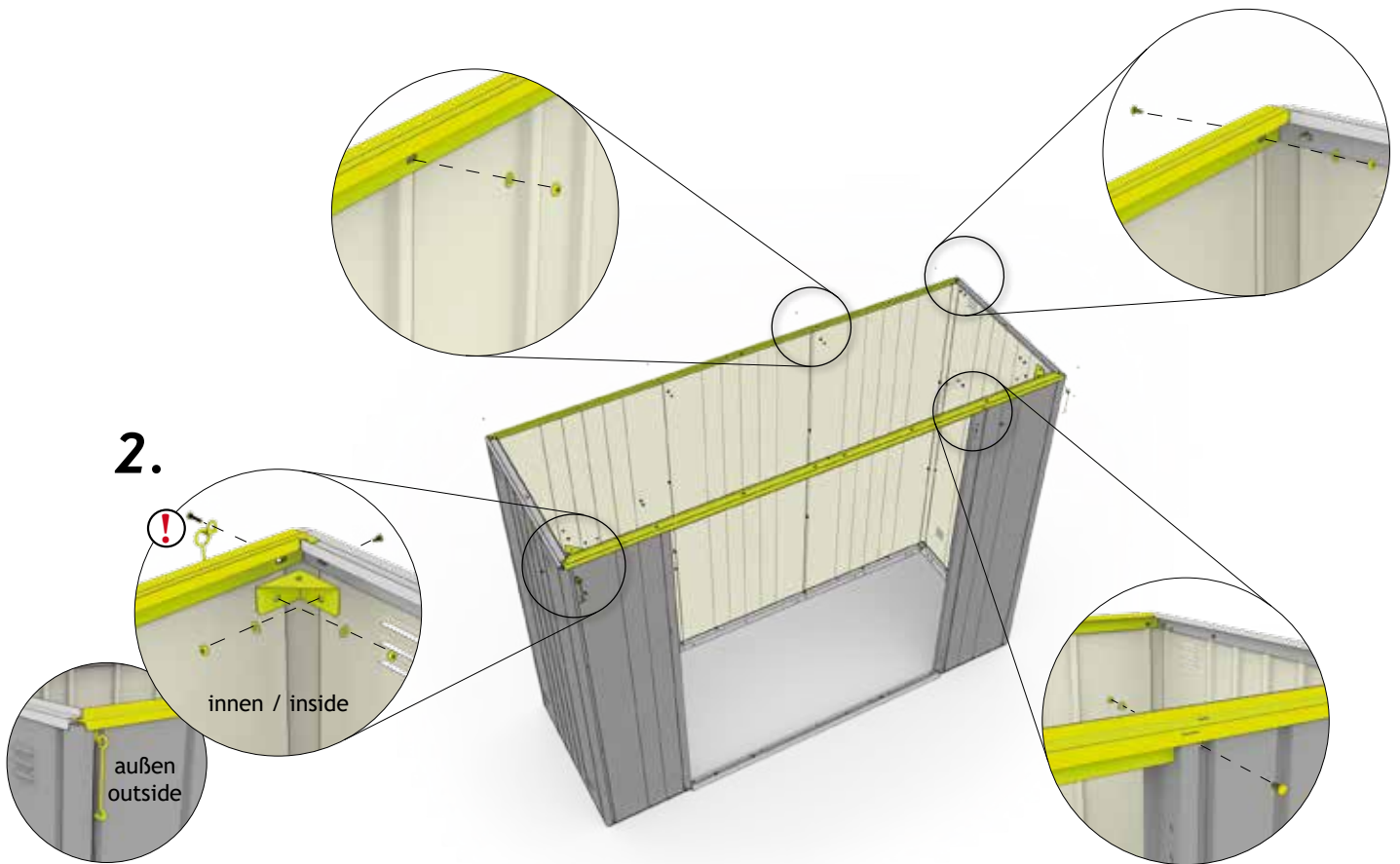

13.



- GS 90: 1x (2850mm)
- GS 150: 2x (2850mm)
- GS 230: 2x (2850mm)

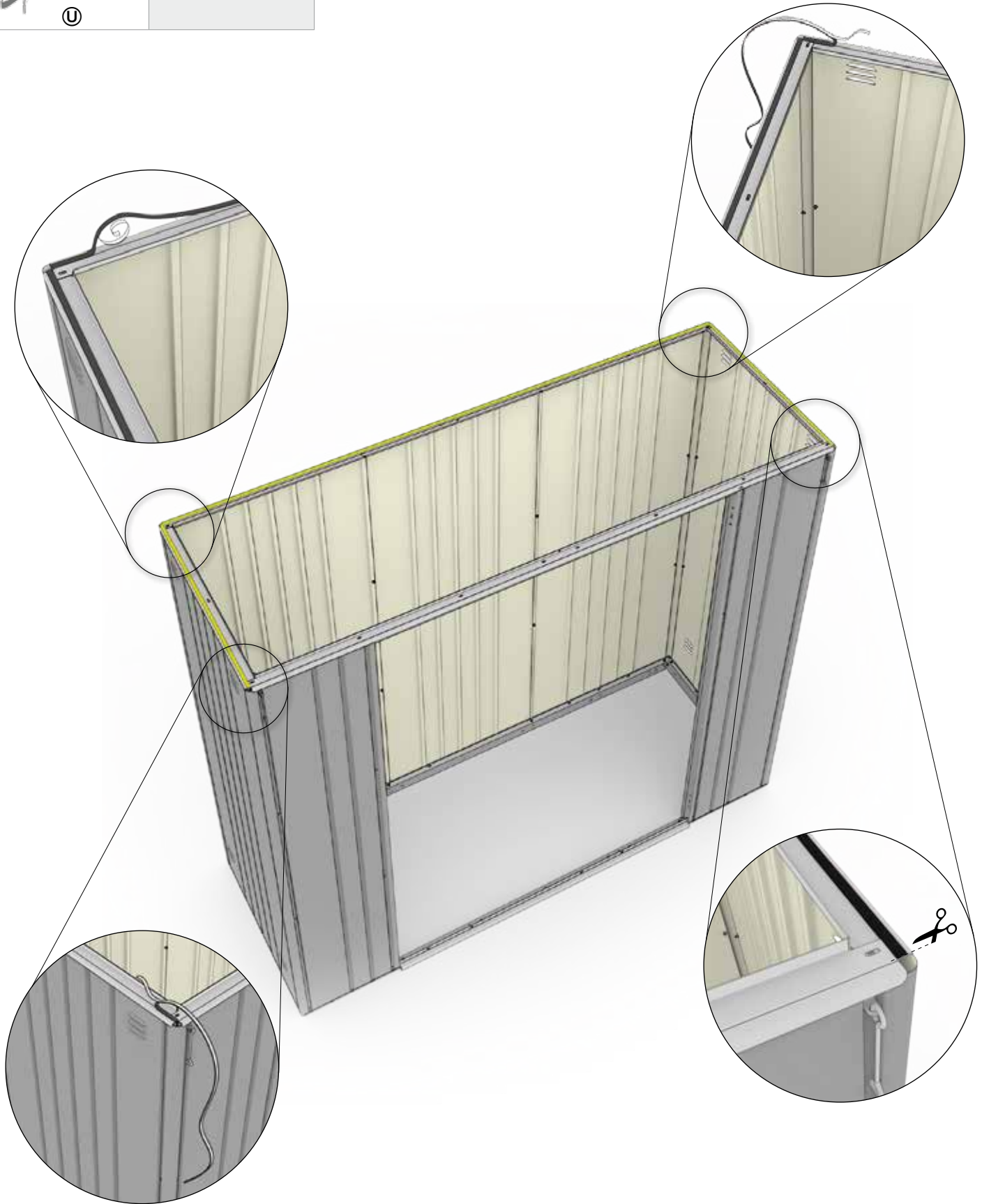

14.

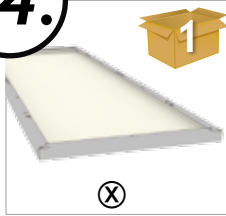
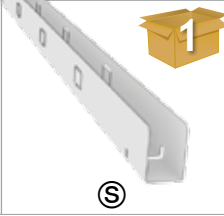
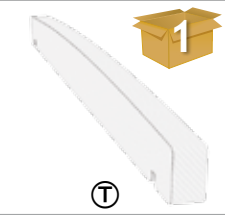
 ⊗	GS 90: 1x GS 150: 1x GS 230: 1x	 Ⓢ	GS 90: 1x GS 150: 2x GS 230: 3x	 Ⓣ	GS 90: 1x GS 150: 2x GS 230: 3x
--	---------------------------------------	---	---------------------------------------	---	---------------------------------------

1.

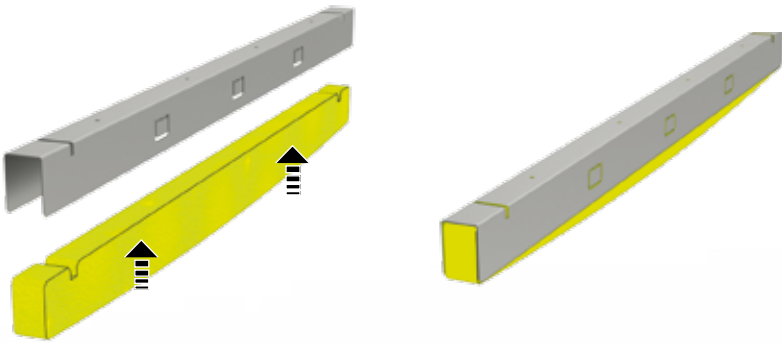

2.

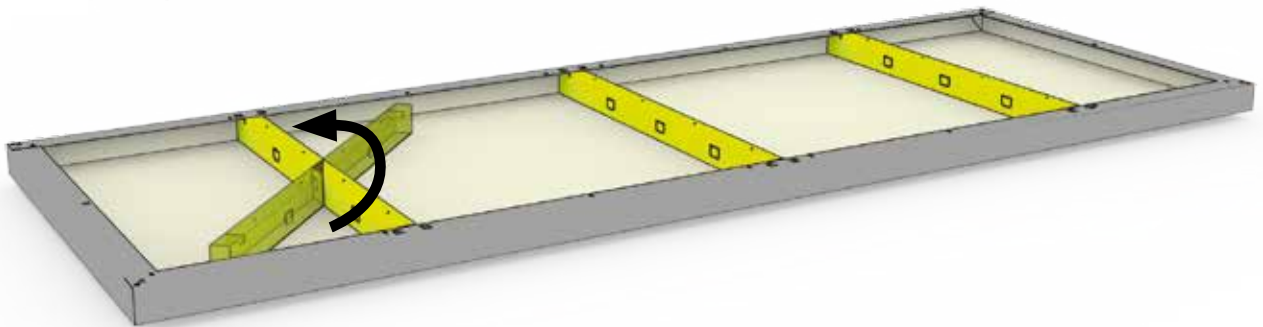

3.

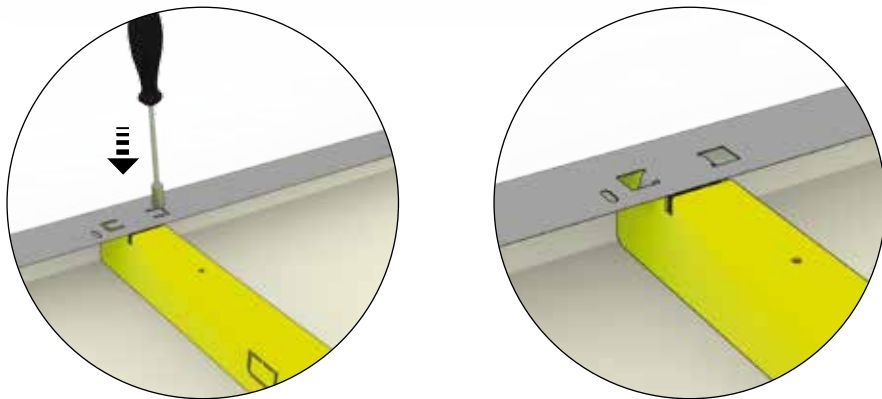

4.



15.

M4 x 10



D2

GS 90: 14x

GS 150: 8x

GS 230: 18x

1.

2.

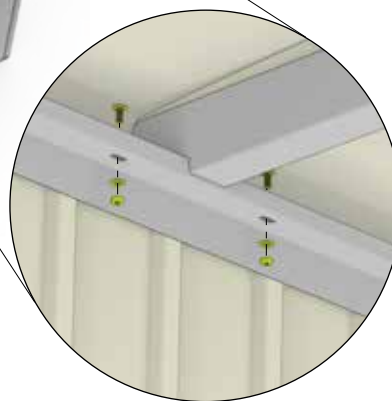
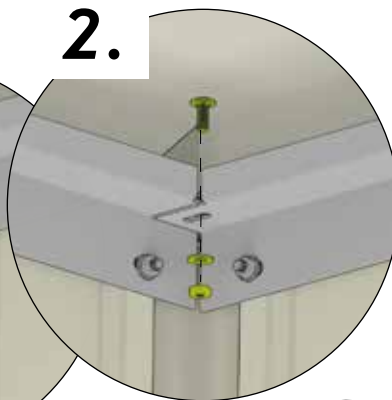
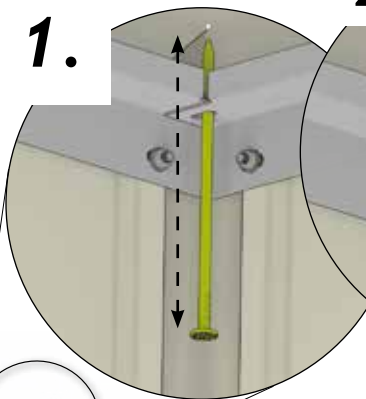
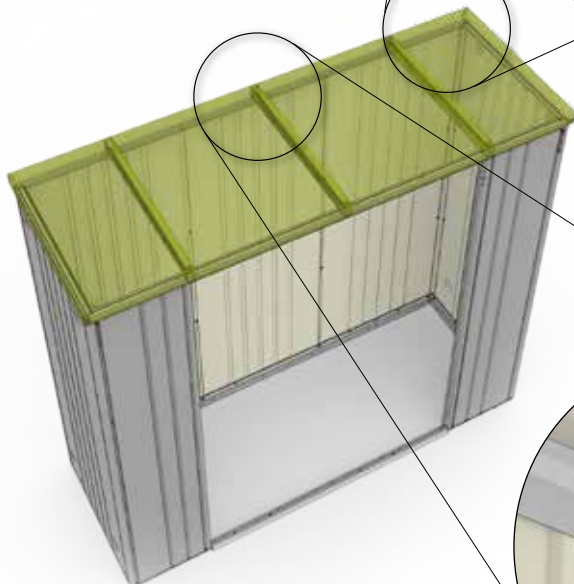

Größenabhängiger Montageschritt - Size-Dependent assembly step - Dépendant de la taille - Size-Dependent montagestep

Nur für Größe 90

Only for width 90 · Juste pour la largeur de 90 · Alleen voor breedte 90 · sólo para el ancho de 90 · solo per larghezza 90 · Kun for størrelse 90

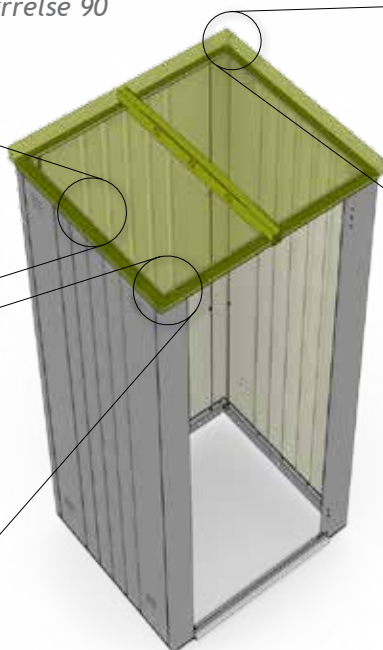
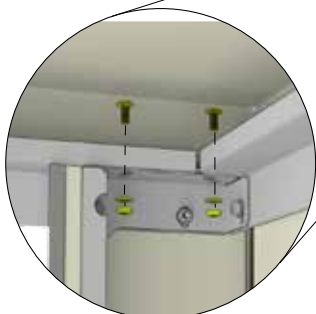
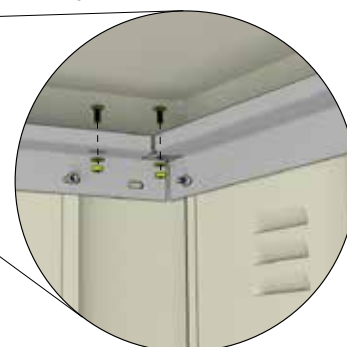
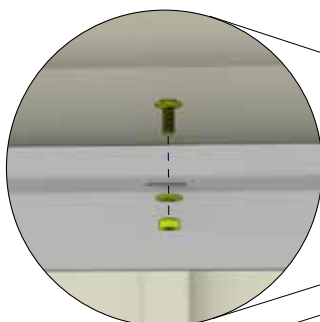

Paso de montaje de tamaño Dependiente - Taglia-Dependent fase di montaggio - Størrelses-anhængig montage skridt



Nur für Größe 90

Only for width 90 · Juste pour la largeur de 90 · Alleen voor breedte 90 · sólo para el ancho de 90 · solo per larghezza 90 · Kun for størrelse 90



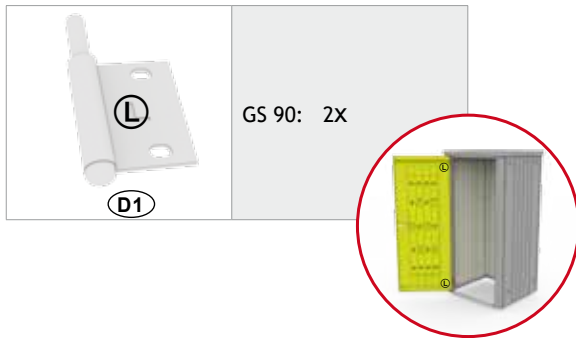

 <p>ⓑ</p>	<p>GS 90: 1x</p>	<p>M4 x 10</p>  <p>ⓓ2</p>	<p>GS 90: 12x</p>
--	------------------	--	-------------------

Variante 1 Proposal 1, Variant 1

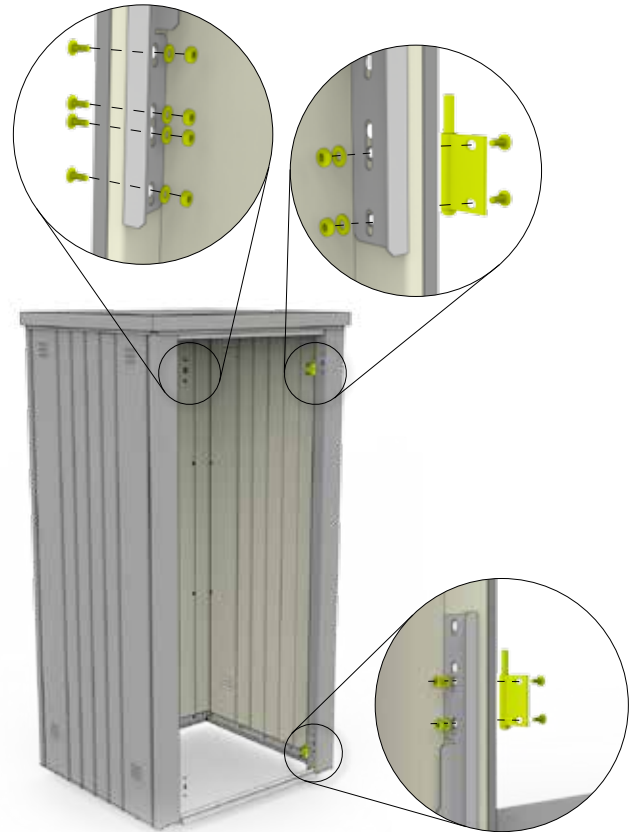
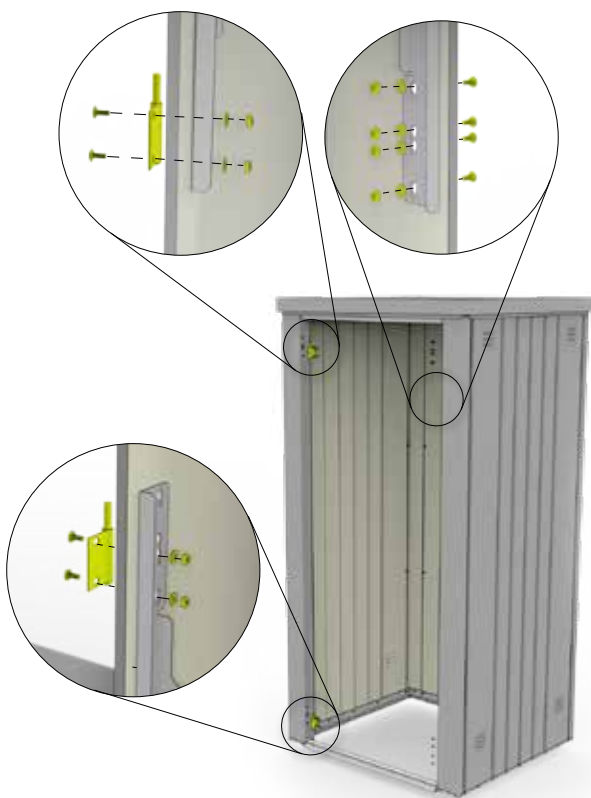
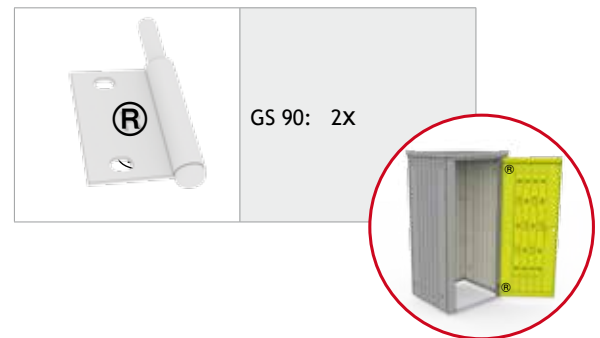

Variante 2 Proposal 2, Variant 2



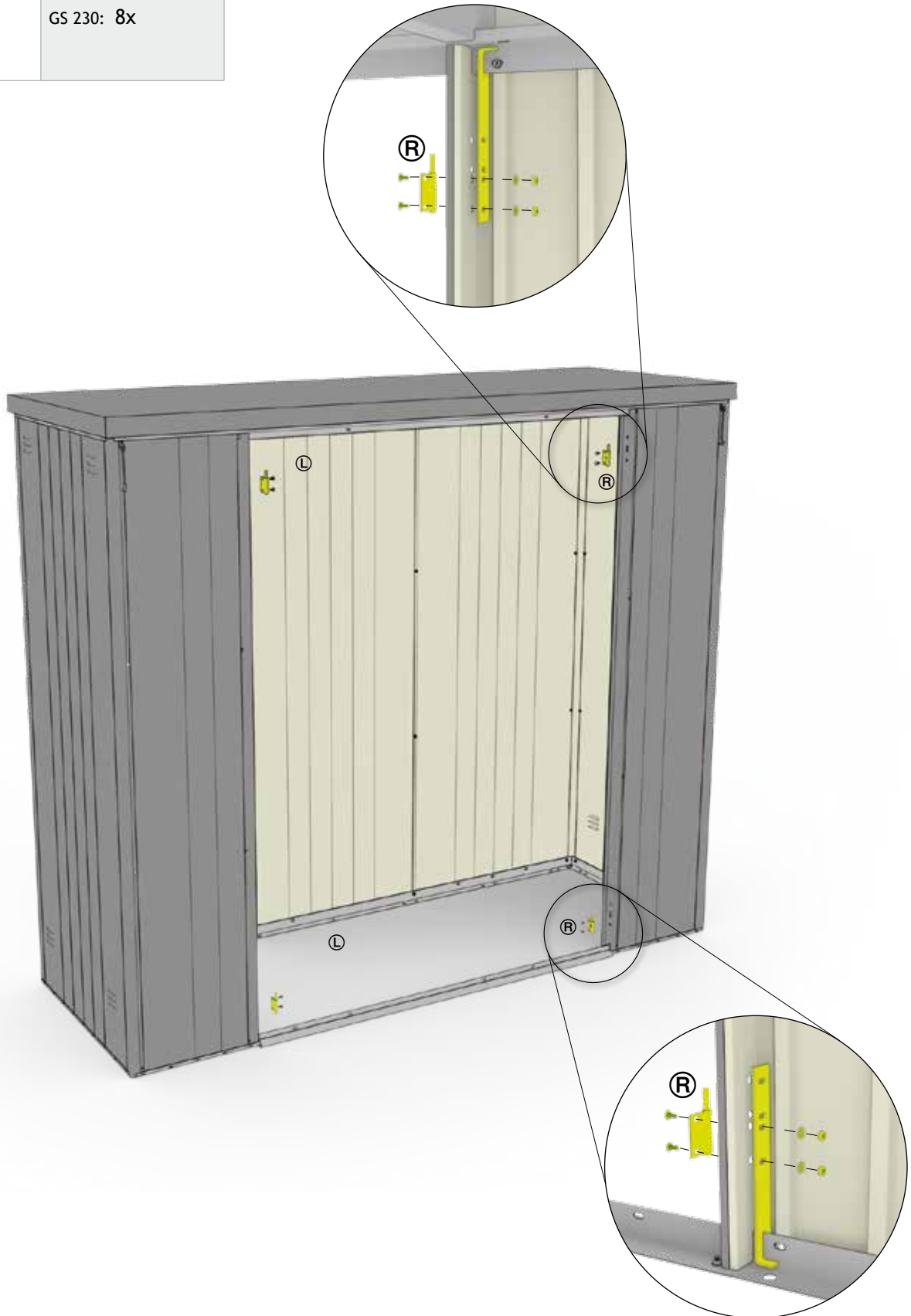

 (D1)	GS 150: 4x GS 230: 4x	 (D1)	GS 150: 2x GS 230: 2x	 (D1)	GS 150: 2x GS 230: 2x
M4 x 10  (D2)	GS 150: 8x GS 230: 8x				





Nur für Größe 90

Only for width 90 · Juste pour la largeur de 90 · Alleen voor breedte 90 · sólo para el ancho de 90 · solo per larghezza 90 · Kun for størrelse 90

 D1	GS 90: 2x	M4 x 10 	GS 90: 4x
---	-----------	--	-----------

Variante 1 Proposal 1, Variant 1

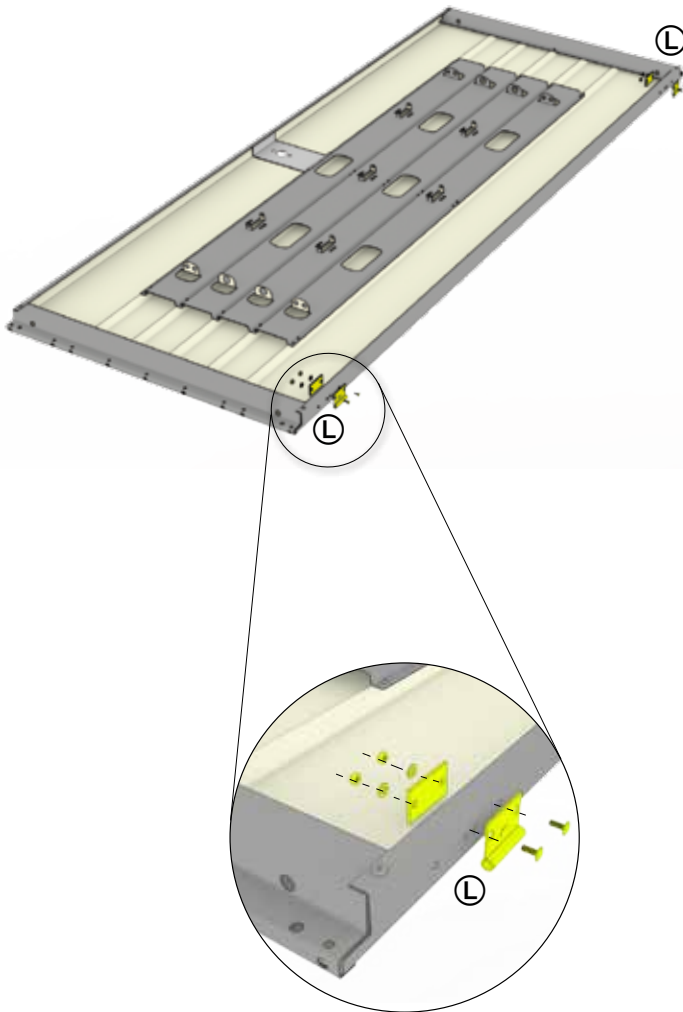
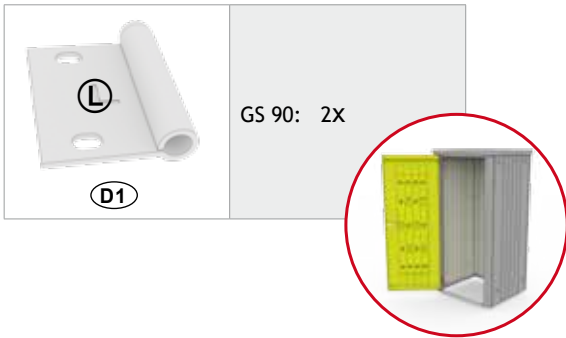



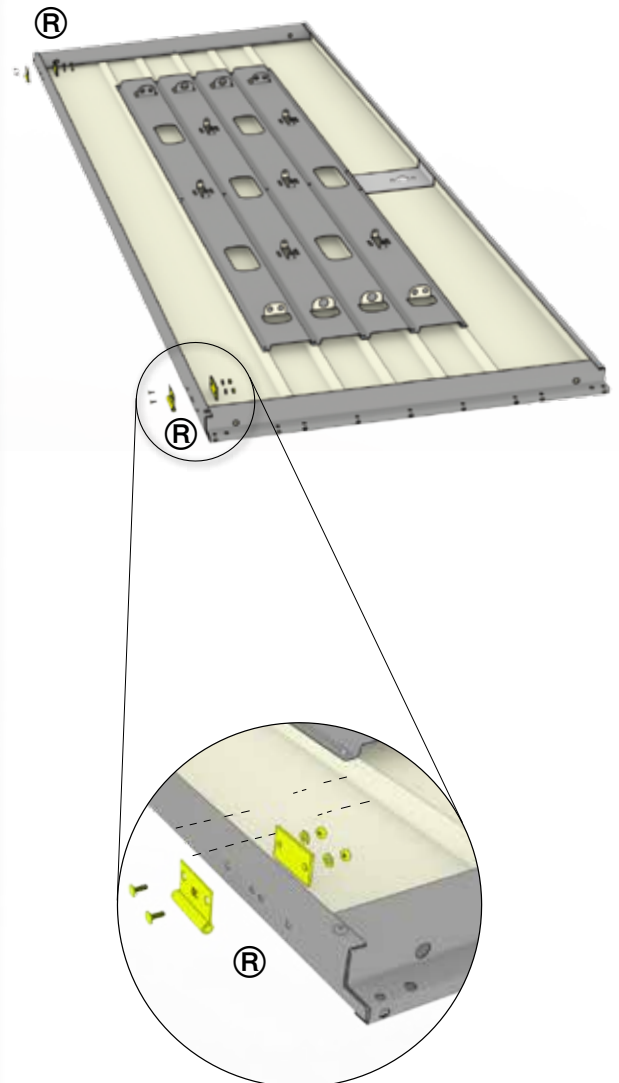
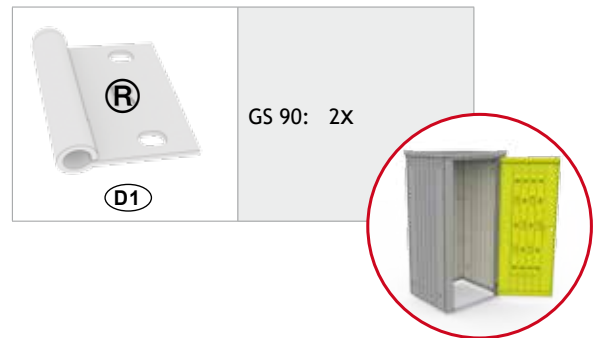

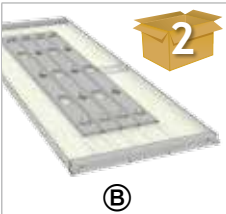
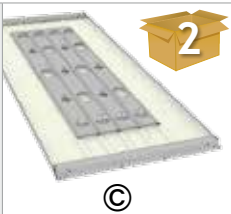
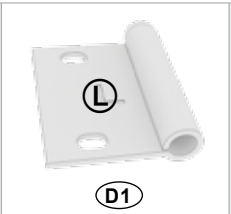
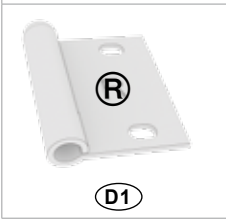
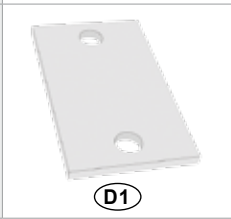
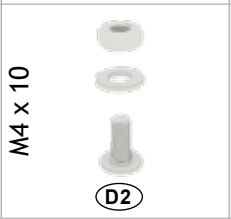
Variante 2 Proposal 2, Variant 2

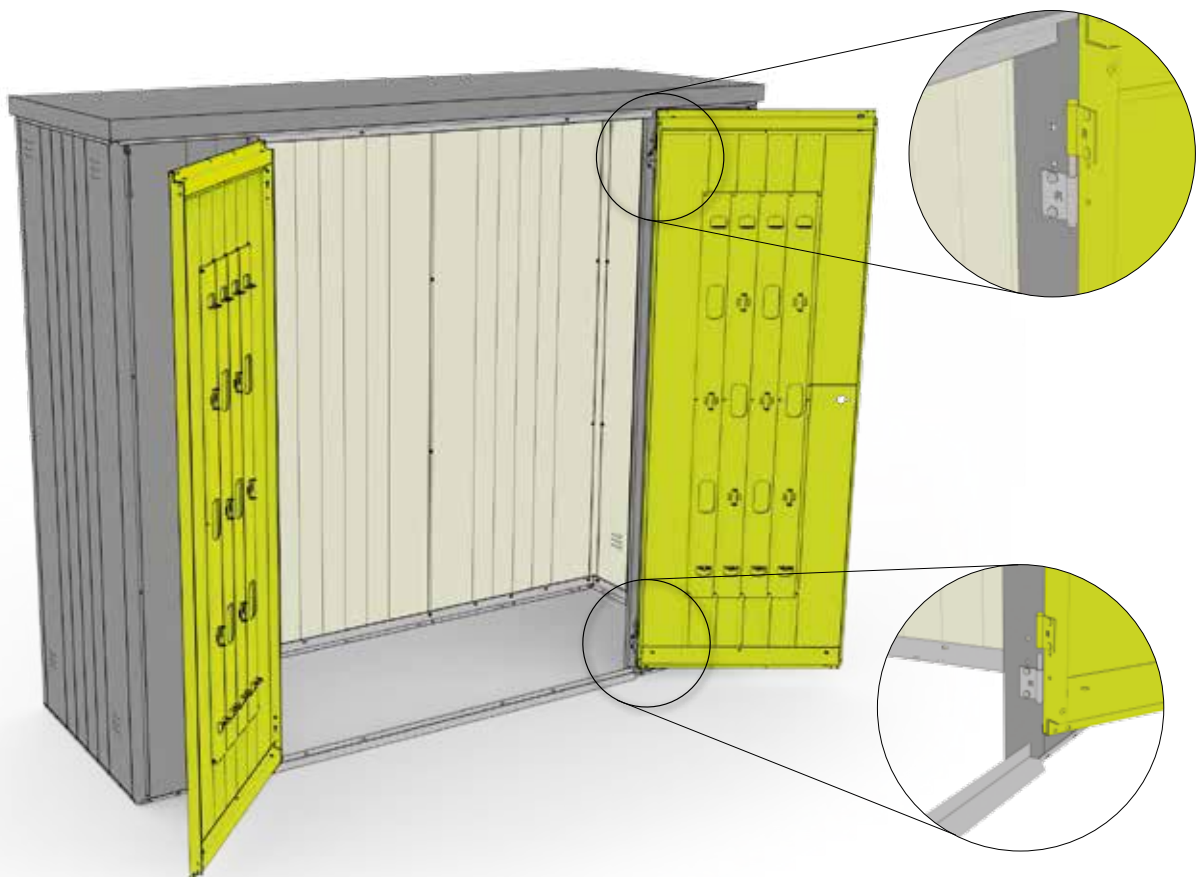
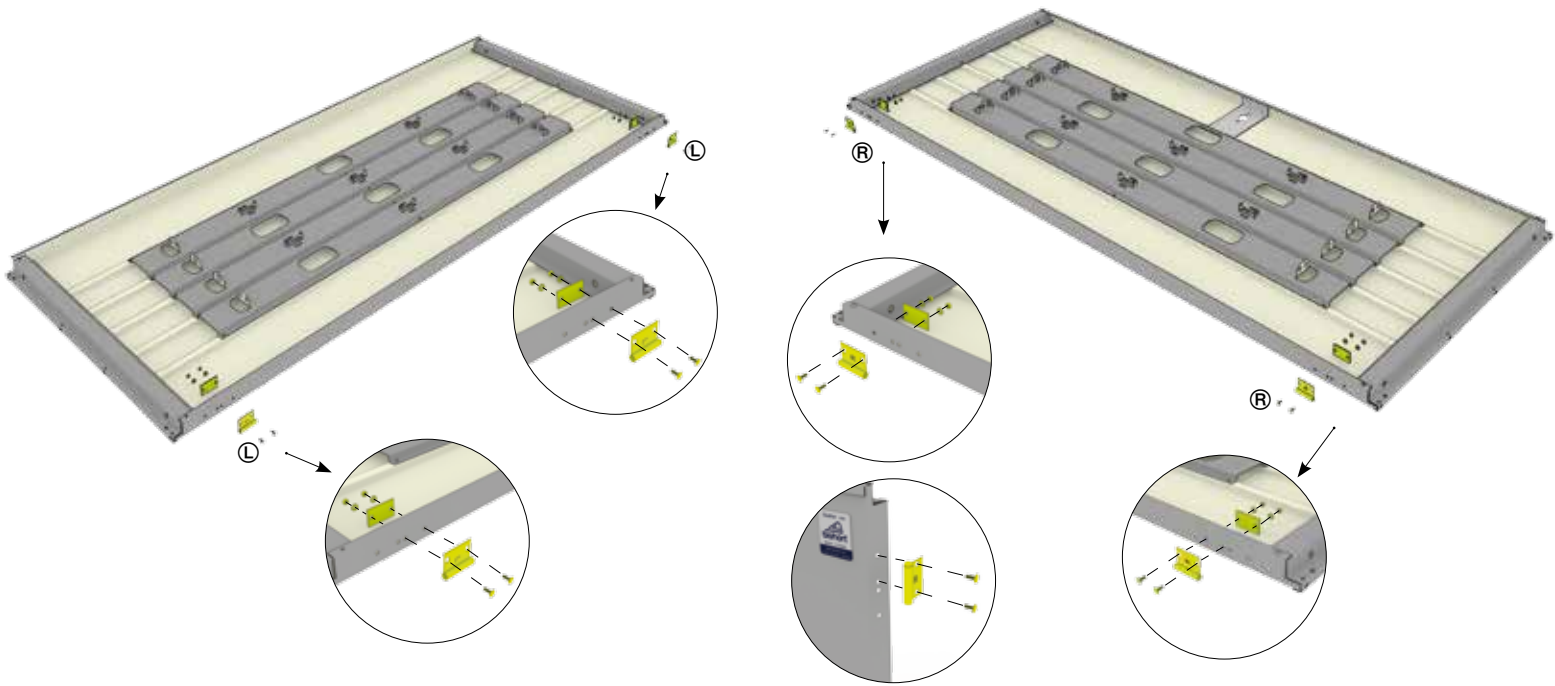

 <p>B</p>	<p>GS 150: 1x GS 230: 1x</p>	 <p>C</p>	<p>GS 150: 1x GS 230: 1x</p>	 <p>D1</p>	<p>GS 150: 2x GS 230: 2x</p>
 <p>D1</p>	<p>GS 150: 2x GS 230: 2x</p>	 <p>D1</p>	<p>GS 150: 4x GS 230: 4x</p>	<p>M4 x 10</p>  <p>D2</p>	<p>GS 150: 8x GS 230: 8x</p>



18.

 (D1)	GS 150: 2x GS 230: 2x	 (D1)	GS 90: 2x GS 150: 4x GS 230: 4x	 (D1)	GS 90: 1x GS 150: 1x GS 230: 1x
M6 x 8  (D1)	GS 90: 2x GS 150: 2x GS 230: 2x	 (D1)	GS 90: 2x GS 150: 4x GS 230: 4x		

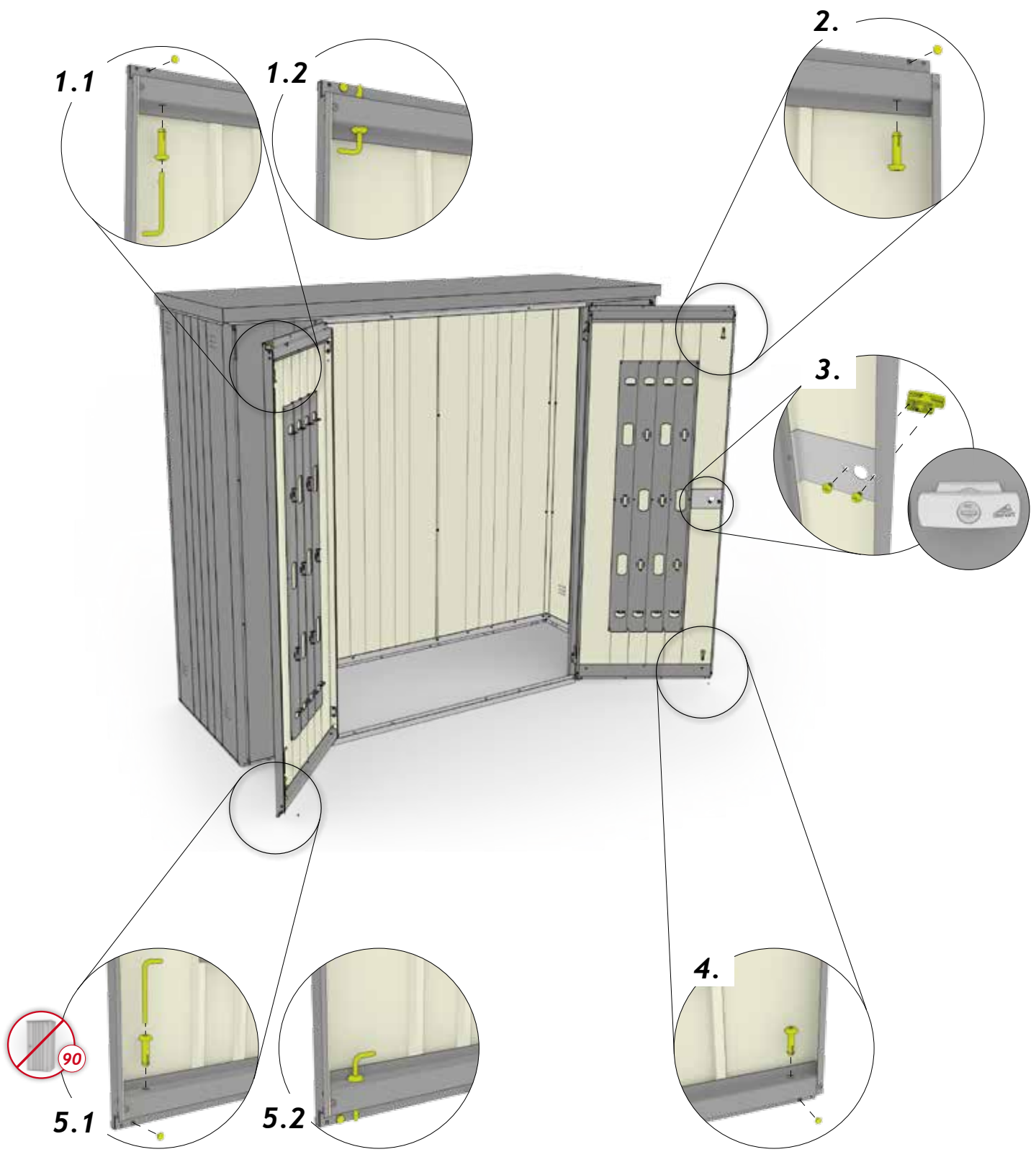

19.



GS 90: 1x
GS 150: 1x
GS 230: 1x



2

GS 90: 2x
GS 150: 2x
GS 230: 2x

M6 x 8



GS 90: 1x
GS 150: 1x
GS 230: 1x

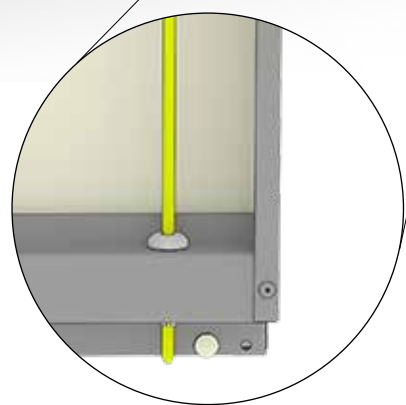
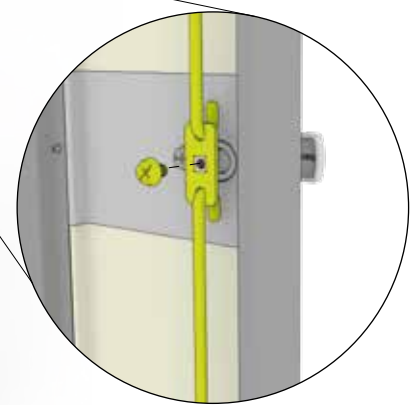
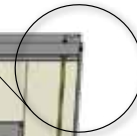
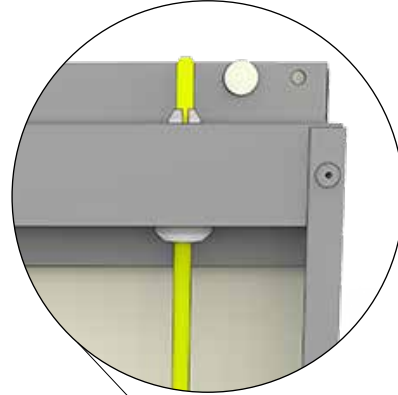
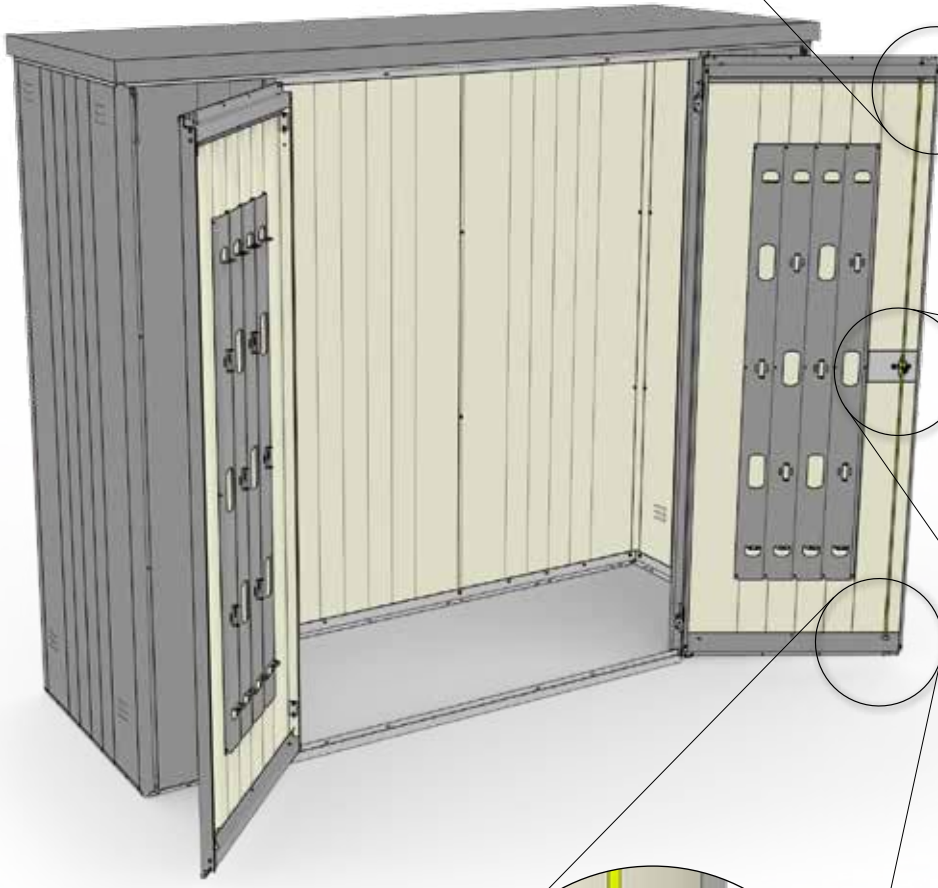

20.

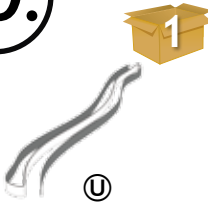
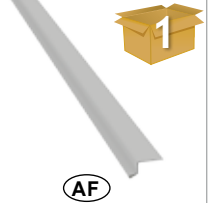
 ①	GS 90: 1x (2850mm) GS 150: 1x (2850mm) GS 230: 1x (2850mm)	 ①	GS 90: 1x GS 150: 1x GS 230: 1x
--	--	--	---------------------------------------

1.

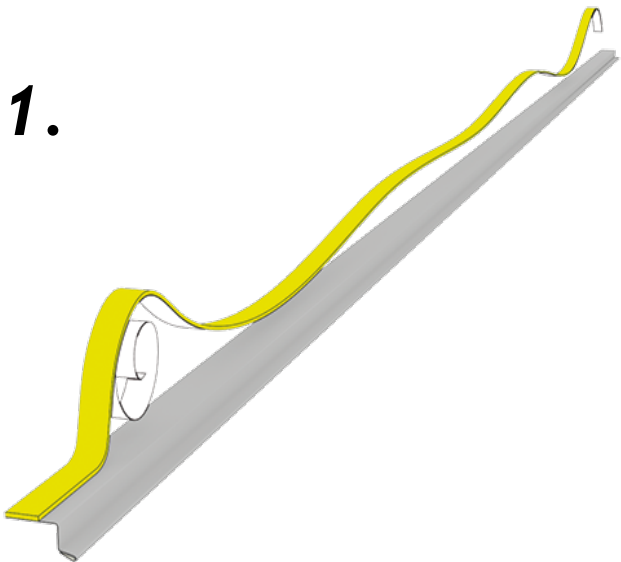

2.

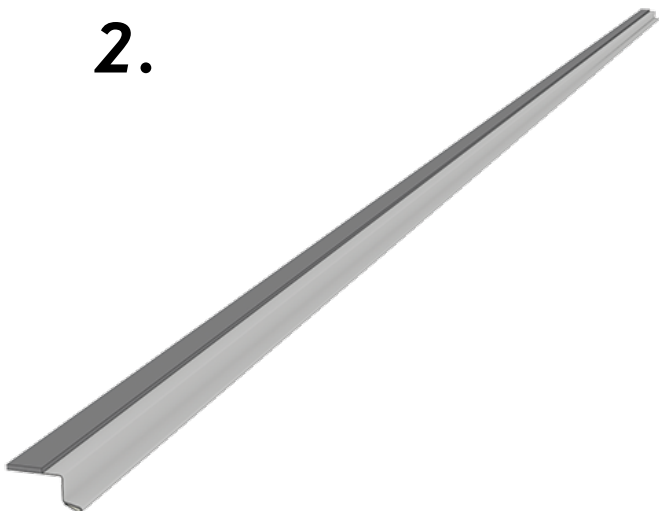

1.1

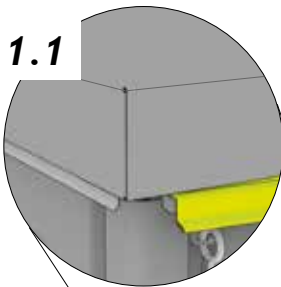

1.2

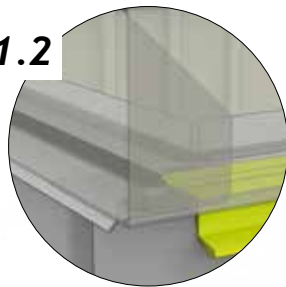

2.

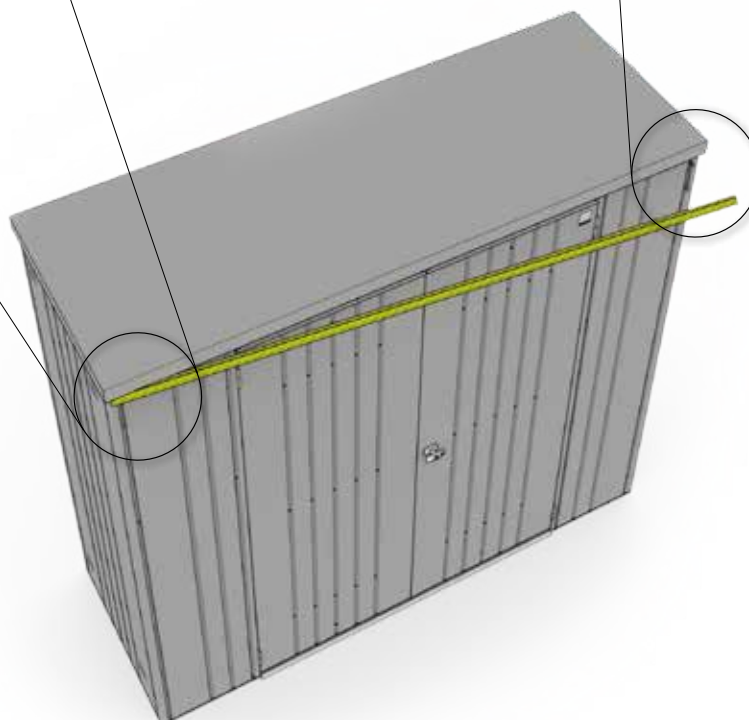
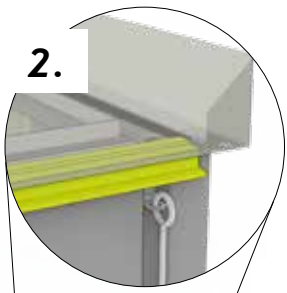

21.



GS 90: 40x
GS 150: 70x
GS 230: 70x

Rechtwinkelig einrichten

- ⒸB rectangular adjusted
- ⒸFR ajuster en forme rectangulaire
- ⒸNL rechthoekig instellen
- ⒸES ajustar en forma rectangular
- ⒸIT mettere in forma rettangolare
- ⒸDK indstil vinkelret

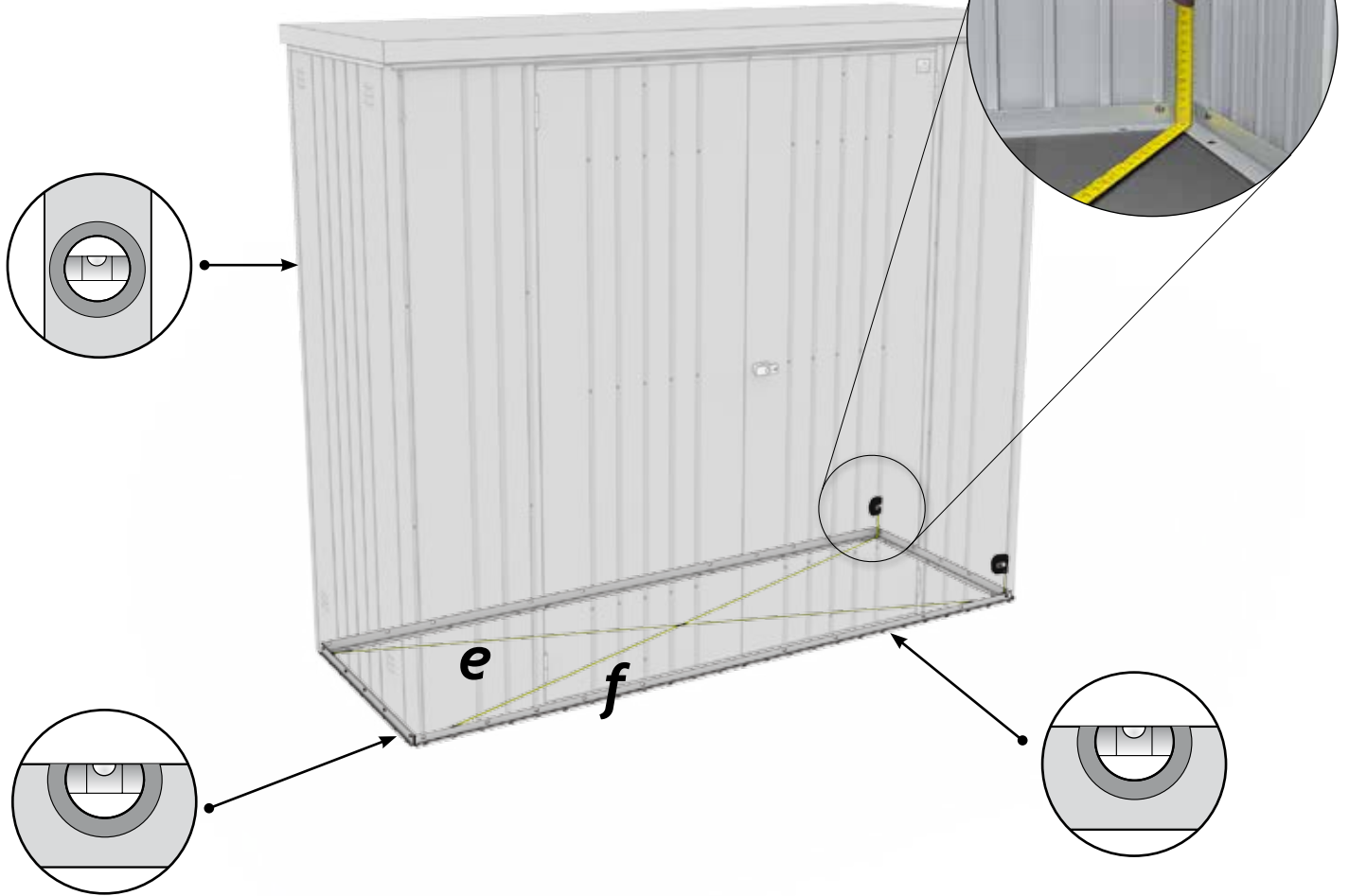

$$e = f$$



Ziehen Sie jetzt alle Schraubverbindungen fest an!

Tighten now all nuts and connections securely! - Serrez maintenant les vis à fond! - Draai nu alle schroeven vast! - Ahora puede apretar y fijar todos los tornillos y tuercas - Adesso serrare a fondo tutti i dadi - Fastspænd nu alle bolt-/skrueforbindelser!

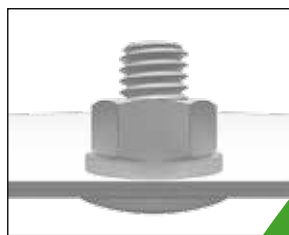

22.

Tür einrichten

- GB align the door
- FR ajuster la porte
- NL deur afstellen
- ES ajuste la puerta
- IT aggiustare la porta
- DK justering af dør

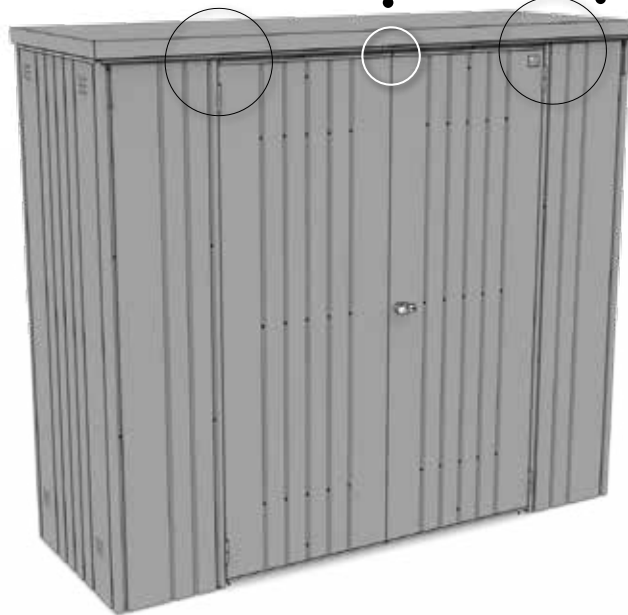
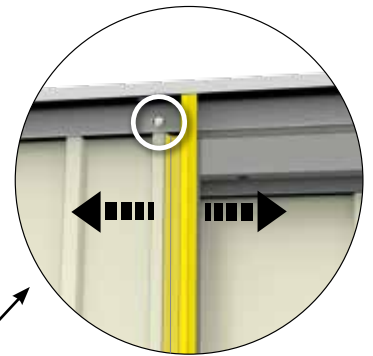
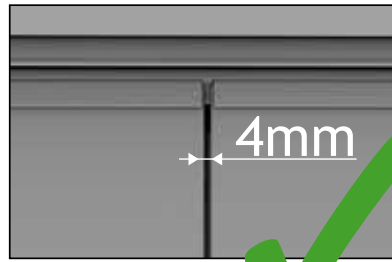

Größenabhängiger Montageschritt - Size-Dependent assembly step - Dépendant de la taille - Size-Dependent montagestep

Nur für Größe 90

Only for width 90 · Juste pour la largeur de 90 · Alleen voor breedte 90 · sólo para el ancho de 90 · solo per larghezza 90 · Kun for størrelse 90

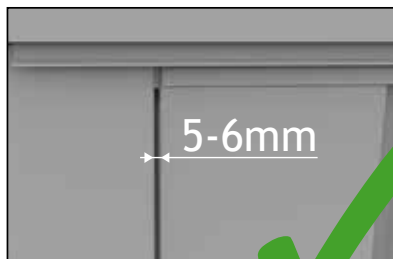

Paso de montaje de tamaño Dependiente - Taglia-Dependent fase di montaggio - Størrelses-anhængig montage skridt

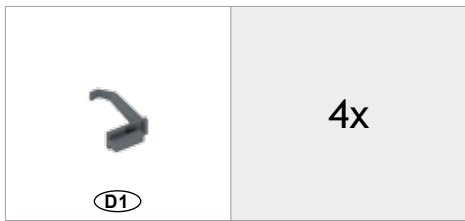

Funktion Windhaken

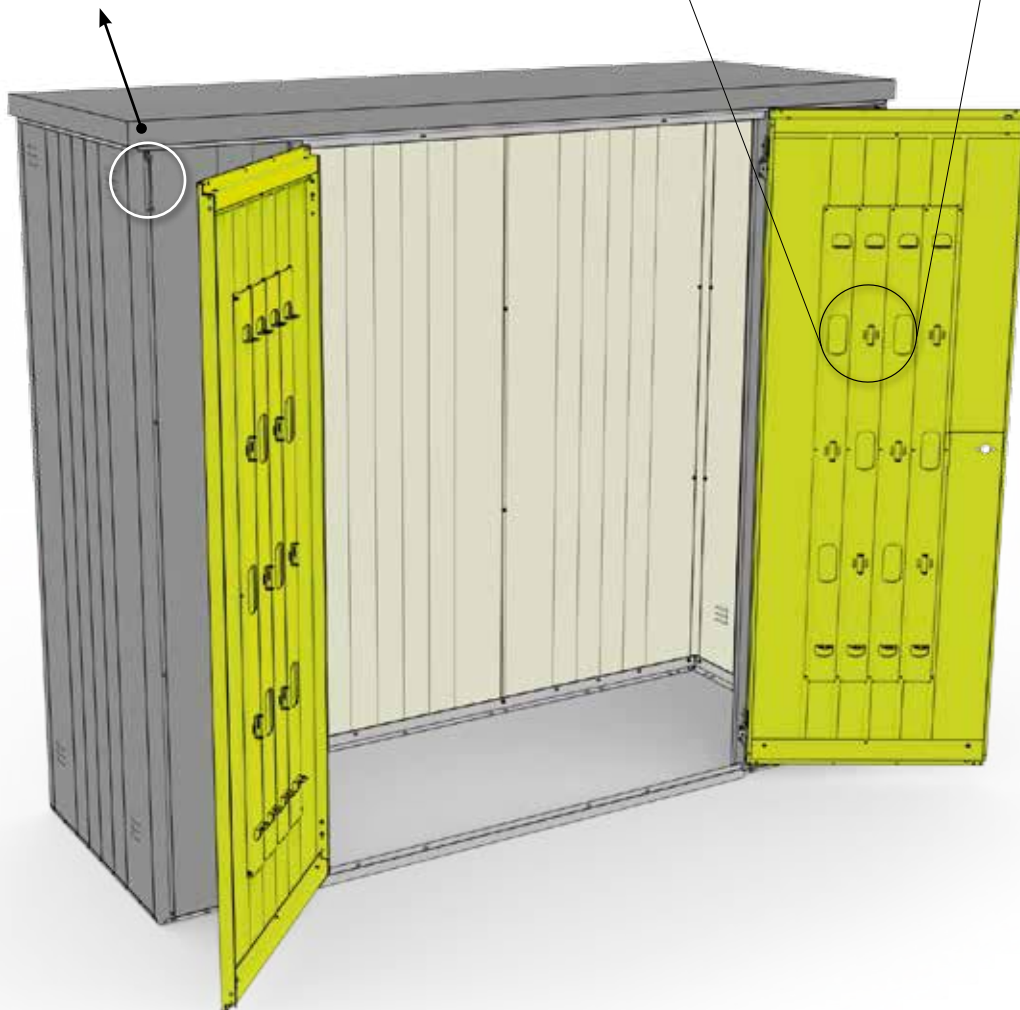
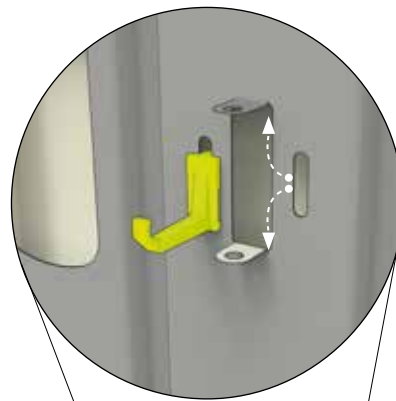
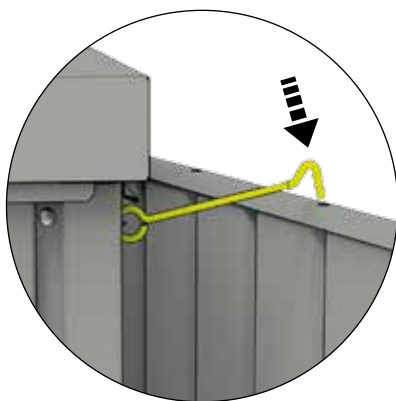

- Ⓒ^{GB} Function of the door hooks
- Ⓒ^{FR} fonction des crochets de porte
- Ⓒ^{NL} Functie van windhaken
- Ⓒ^{ES} Función de los topes de seguridad
- Ⓒ^{IT} Funzione gancio fermaporta
- Ⓒ^{DK} Stormkrogenes funktion







Bodenrahmen

Floor frame · Cadre de sol · Bodemframe · Marco de suelo · Telaio perimetrale · Bundramme

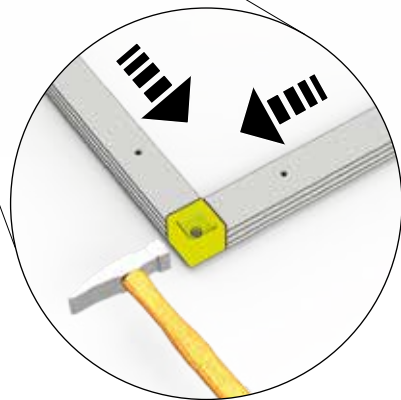
 <p>ZB</p>	<p>GS 90: 2x (800mm) GS 150: 2x (1420mm) GS 230: 2x (2140mm)</p>	 <p>ZB</p>	<p>GS 90: 2x (700mm) GS 150: 2x (700mm) GS 230: 2x (700mm)</p>	 <p>ZC</p>	<p>GS 90: 4x GS 150: 4x GS 230: 4x</p>
--	--	--	--	--	--



 <p>ZD</p>	GS 90: 4x	 <p>ZF</p>	GS 90: 12x
	GS 150: 4x		GS 150: 12x
	GS 230: 6x		GS 230: 12x

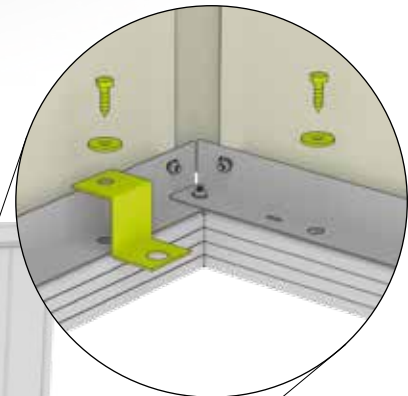
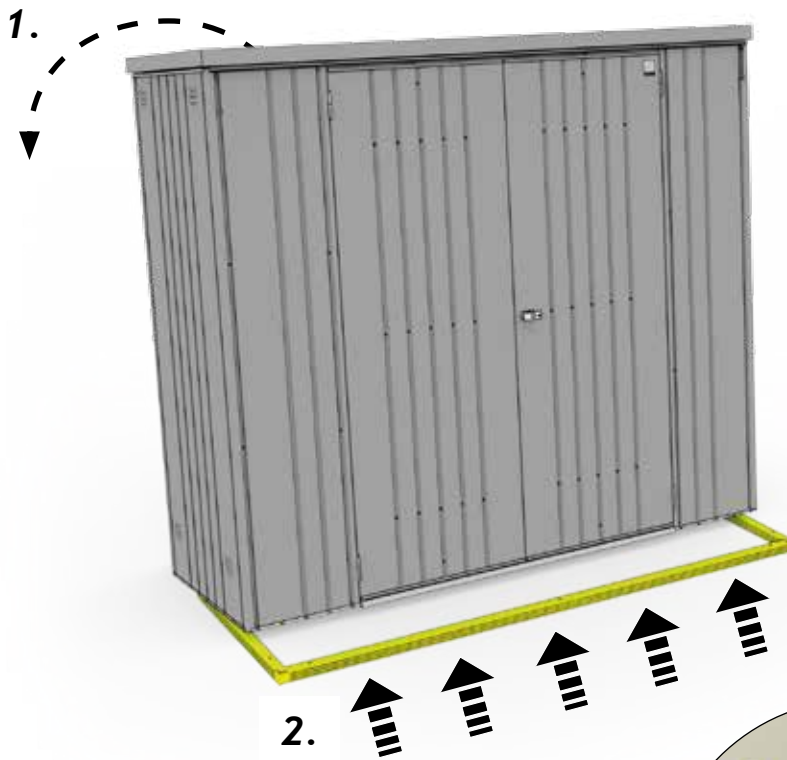



Bodenrahmen

Floor frame · Cadre de sol · Bodemframe · Marco de suelo · Telaio perimetrale · Bundramme

Variante 1 - (Seite 5), Proposal 1 - (page 5), Variant 1 - (page 5)

	GS 90: 4x
	GS 150: 4x
	GS 230: 6x

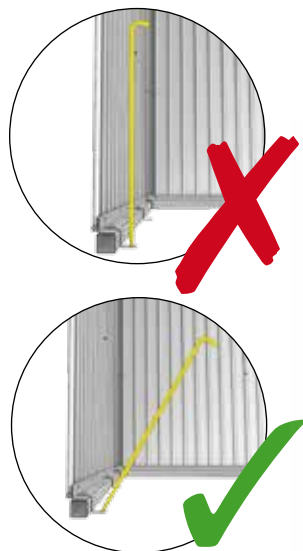

Variante 2 - (Seite 5), Proposal 2 - (page 5), Variant 2 - (page 5)

8 x 60		GS 90: 4x
		GS 150: 4x
		GS 230: 6x

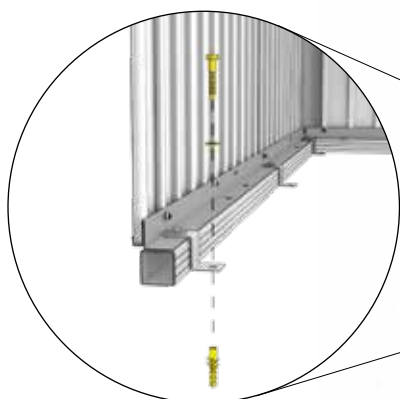



23.

8 x 60 (D1)		GS 90: 6x
		GS 150: 6x
		GS 230: 6x

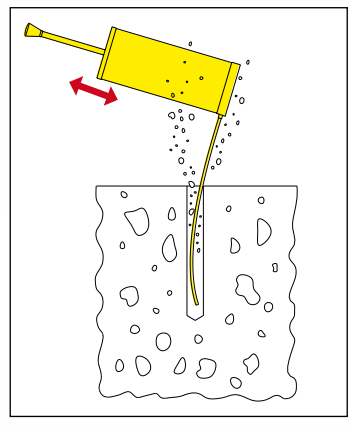
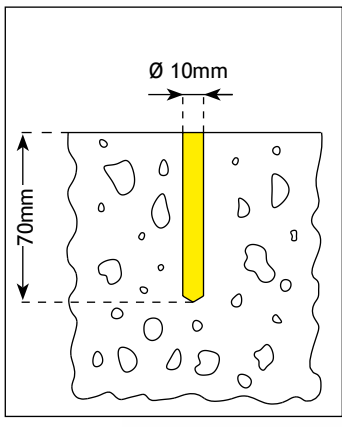
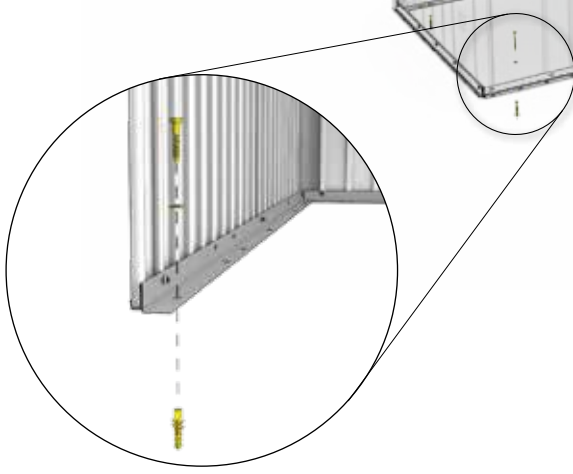
Variante 3 - (Seite 5), **Proposal 3** - (page 5), **Variant 3** - (page 5)



24.

 (A1)		GS 150: 4x
		GS 230: 4x
		GS 90: 4x



KLICK



25.

2

GS 90: 2x
GS 150: 2x
GS 230: 2x

®

1.

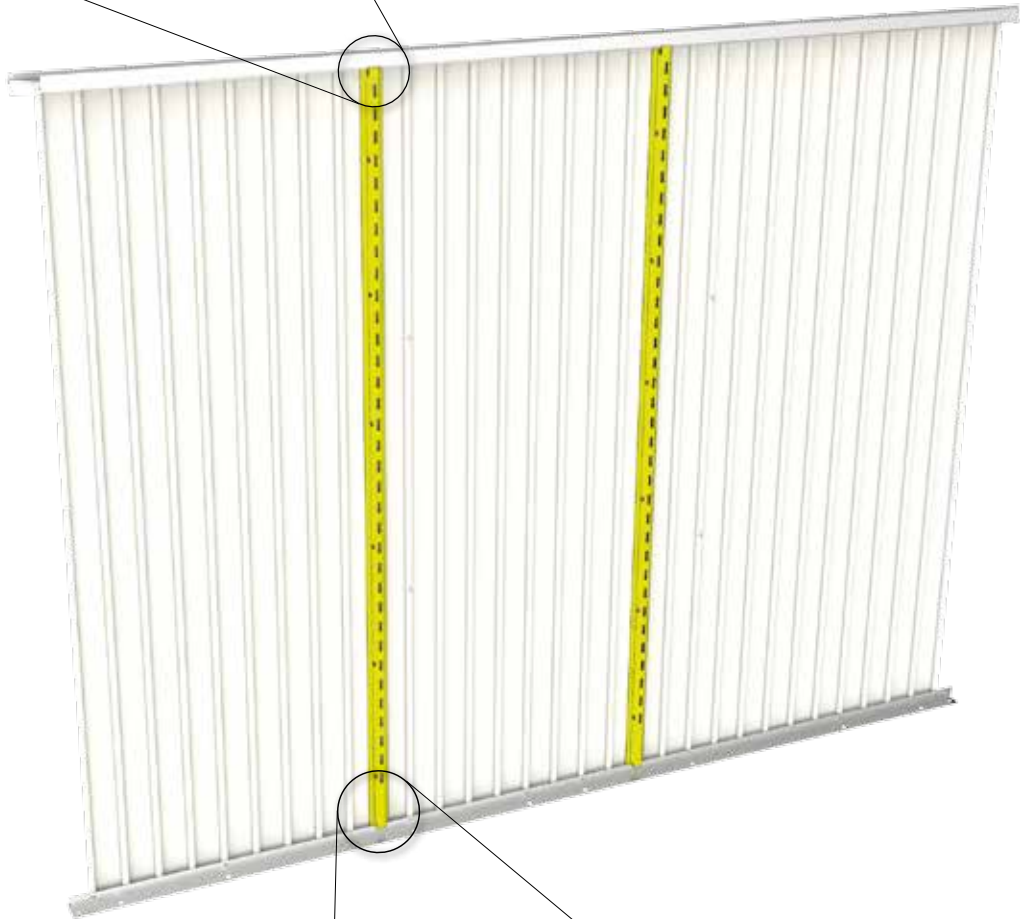
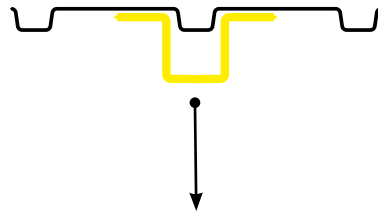
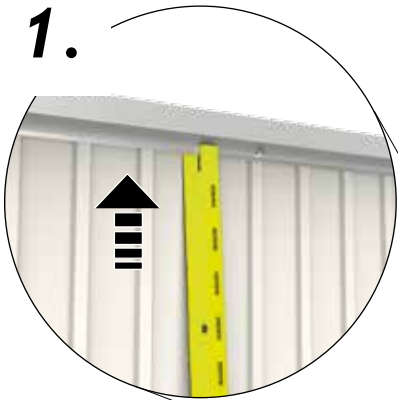

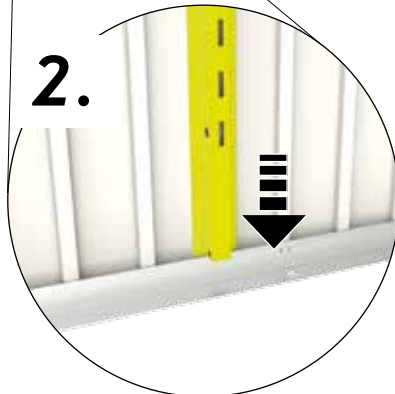

2.

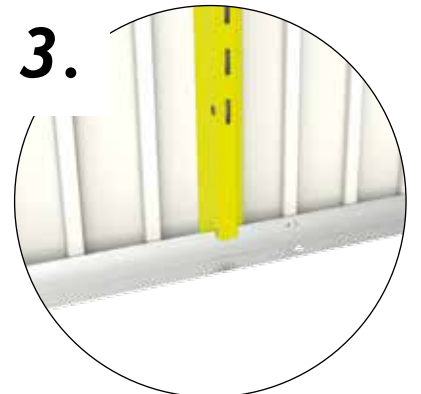

3.



26.

	GS 90: 2x		GS 90: 4x
	GS 150: 2x		GS 150: 4x
	GS 230: 2x		GS 230: 4x

Option 1:

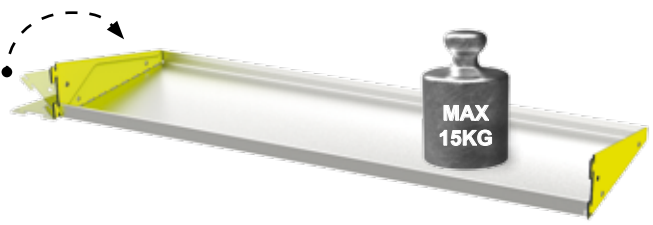

Option 2:

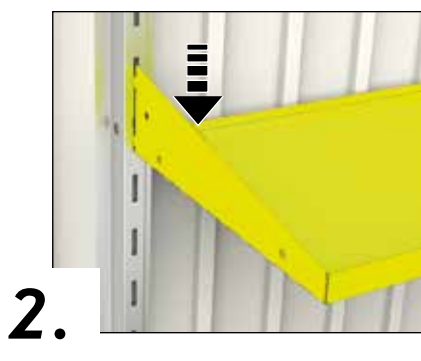
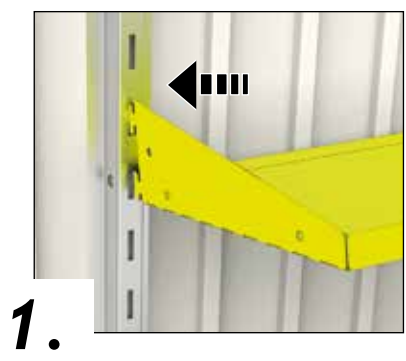
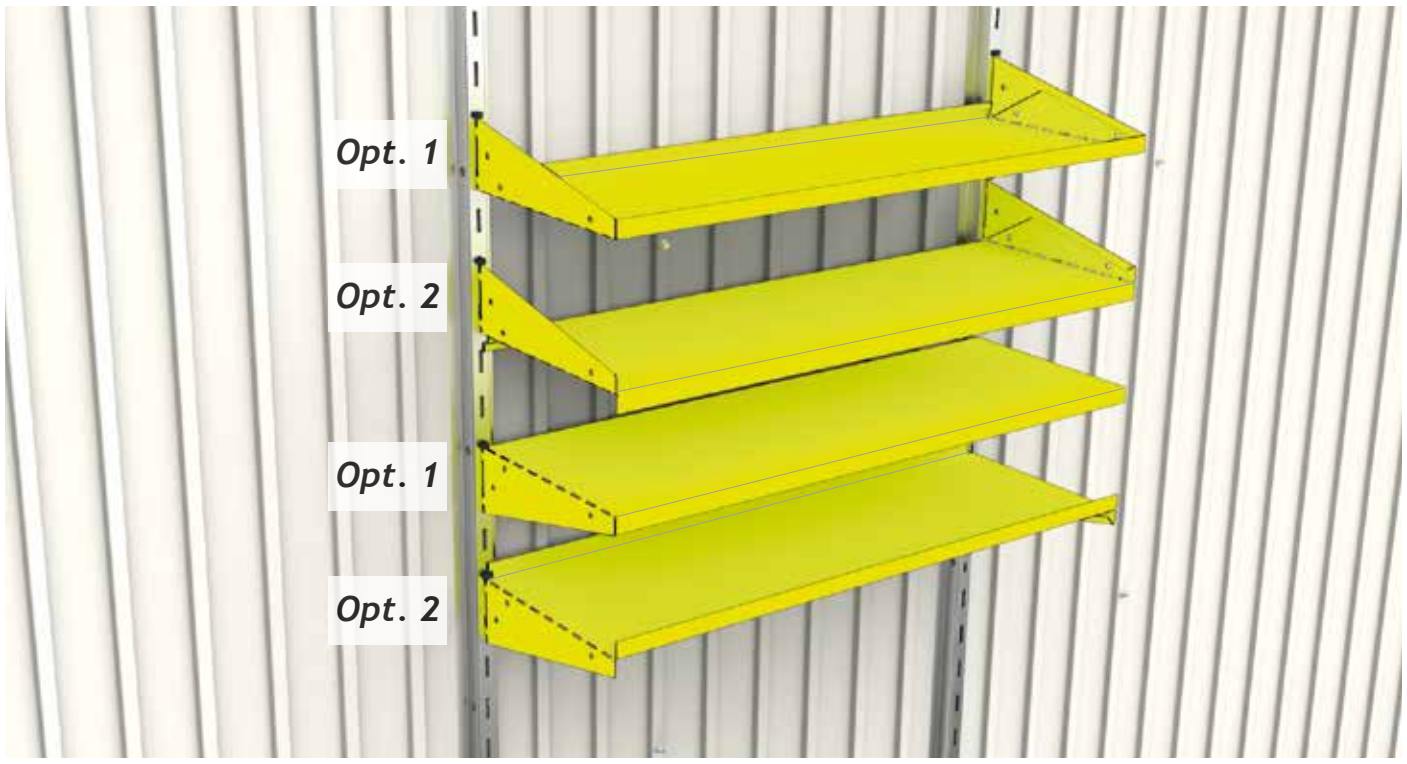



HighLine®

Das ultimative Gerätehaus, das hinsichtlich Sicherheit und Funktionalität alle Anforderungen erfüllt.



Panorama®

Dieses Satteldachmodell passt in jedes Gartenpanorama. Stabilität und Design für höchste Ansprüche.



AvantGarde®

Passt bestens zu moderner Architektur und macht lebenslang Freude.



Europa

Alles in bester Ordnung und lebenslange Wartungsfreiheit mit dem Biohort-Klassiker.



Geräteschrank

Wo Raum knapp ist, zeigt er seine Klasse – im Garten, auf der Terrasse, in der Garage.



MiniGarage

Multifunktionales Stauraumwunder ohne Genehmigungspflicht.



WoodStock®

Kaminholzlager und Geräteschrank in einem, auch zum einfachen Wand-Anbau geeignet.



StoreMax®

Funktionelles Design für maximalen Stauraum auf wenig Platz.



HighBoard

Das formvollendete Multitalent zum Aufbewahren. Mit Flügeltüren und Deckelöffnung.



CornerBoard

Bietet wertvollen Platz auf Balkon und Terrasse.



LoungeBox®

Die Design-Box für gehobene Ansprüche - ein Schmuckstück für Terrasse und Garten.



FreizeitBox

Ideal zum Verstauen von Sitzkissen, Sonnenliegen und Spielzeug.



HochBeet

Schönste Aussicht auf beste Ernte.



Pflanzbeet Belvedere®

Der Blickfang für die Terrasse.



Komposter MonAmi®

Vereint Zweckmäßigkeit mit stilvollem Auftreten.

EXTRA PROSPEKT
anfordern unter
www.biohort.com



Nebengebäude CasaNova®

Design, das sich Ihren Wünschen anpasst.



Biohort GmbH

Pürnstein 43, 4120 Neufelden, Österreich
Tel.: +43-7282-7788-0, Fax-DW: 190
E-Mail: office@biohort.at, www.biohort.com

