

**28MM 355X940 CM WDDDC03+EXTXXL (ART3504EXTXXL)**

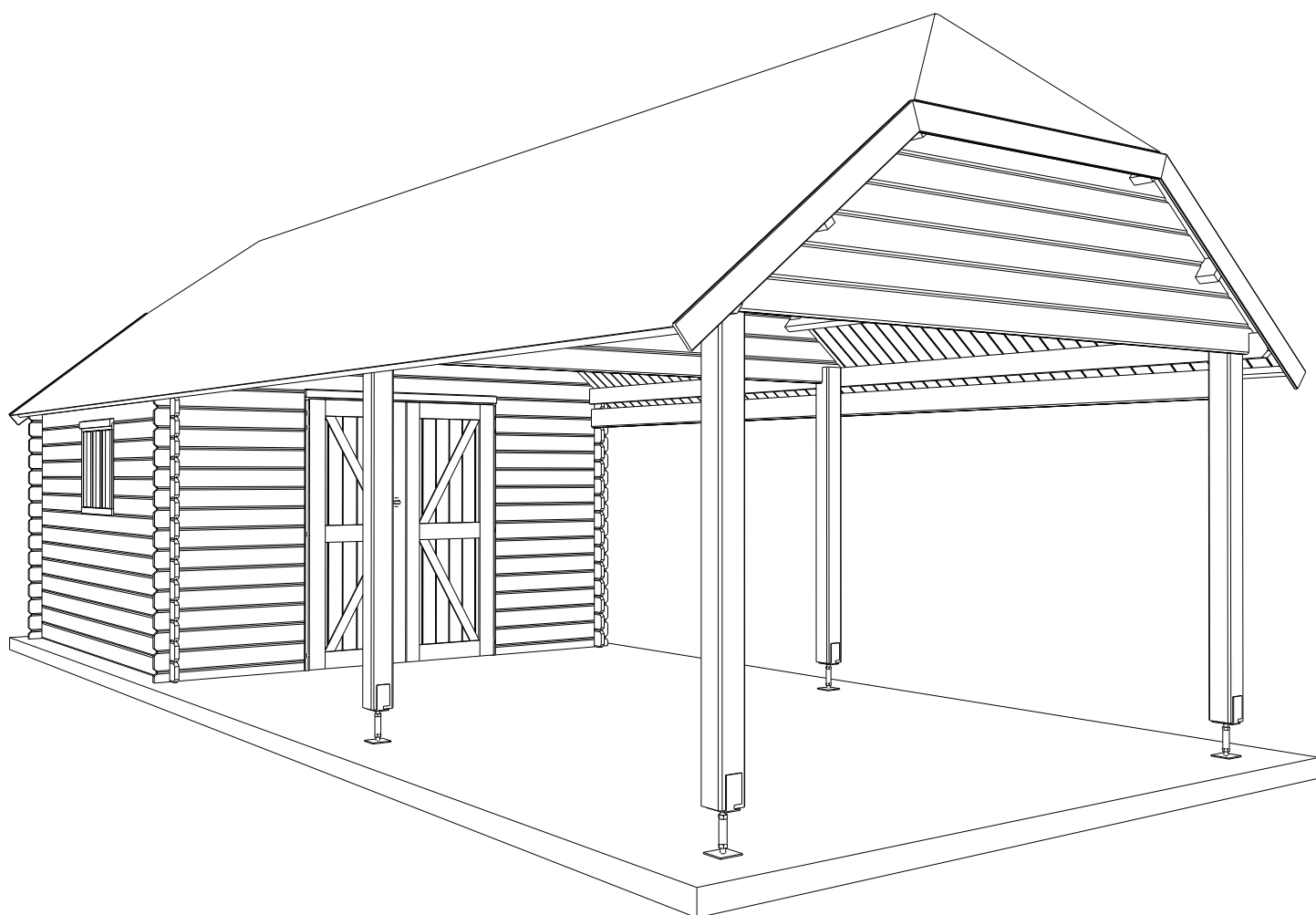

# **WOODLANDS**

**QUALITY CABINS**



**GEDETAILEERDE ONDERDELENLIJST**

-

**LISTE D'INVENTAIRE DETAILLEE**

# Onderdelenlijst Liste d'inventaire

# Typ diamond **28mm 355x355 cm WDDDC03**

## 3504

Artikel nr / Nr Article      Afmeting / Dimension      #      Functie/Fonction  
A      B      C

### Wandelementen / Eléments des parois

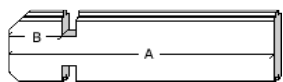

C1/1039/0100	1039	100	(-)	<b>24</b>	naast deur voorgevel / côté porte façade
C1/1387/0100	1387	100	(-)	<b>10</b>	naast raam zijgevel / côté fenêtre paroi latérale

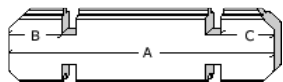

C3/3550/0100/0100	3550	100	100	<b>12</b>	achtergevel / paroi arrière
C3/3550/0100/0100	3550	100	100	<b>19</b>	zijgevel / paroi latérale

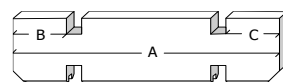

C5/3550/0100/0100	3550	100	100	<b>2</b>	hoogste oversteek zijgevel / traverse supérieure paroi latéral
-------------------	------	-----	-----	----------	---



C7/3550/0100/0100	3550	100	100	<b>2</b>	basis voor- & achtergevel / base paroi avant & arrière
-------------------	------	-----	-----	----------	--

### Dakelementen / Eléments du toit

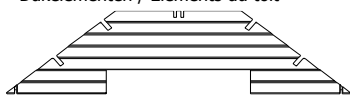

CK/C7/3550/QQ001	3550	(-)	(-)	<b>1</b>	puntgevel te assembleren voor / pignon à assembler façade
------------------	------	-----	-----	----------	--

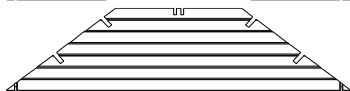

CK/C7/3550/5/4	3550	(-)	(-)	<b>1</b>	puntgevel te assembleren achter / pignon à assembler parois arrière
----------------	------	-----	-----	----------	--

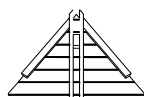

WD/C/1485	1485	(-)	(-)	<b>2</b>	driehoek wolfsdak / triangle croupe faitière
-----------	------	-----	-----	----------	--

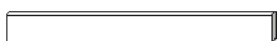

S/028/045/1000	1000	28	45	<b>2</b>	versteving puntgevel / renfort pignon
----------------	------	----	----	----------	---------------------------------------

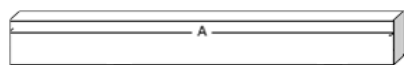

P4/3550	3550	120	44	<b>4</b>	dakbalk / panne de toit
---------	------	-----	----	----------	-------------------------

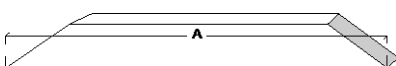

599908	2570	45	45	<b>1</b>	nokbalk / panne faitière
--------	------	----	----	----------	--------------------------



DP/2380	2380	(-)	(-)	<b>62</b>	dakplanchet / planchette du toit
---------	------	-----	-----	-----------	----------------------------------

### Afwerkingselementen / Eléments de finition



SRD/0807	807	(-)	(-)	<b>2</b>	sierlat boven raamkader / latte de finition cadre de fenêtre
SRD/1502	1502	(-)	(-)	<b>2</b>	sierlat boven deurkader / latte de finition cadre de porte

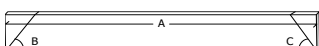

FSL/1650	1583	70	70	<b>2</b>	frontale sierlat / latte de finition frontale <b>Afzagen op lengte van 1583mm (A) en beide hoeken in verstek op 70° (B &amp; C)</b> <b>Scier à la longueur de 1583 mm (A) et les deux coins à un angle de 70° (B &amp; C)</b> <b>Zie montage instructie - Voir instructions de montage (stap 47 - point 47)</b>
----------	------	----	----	----------	--

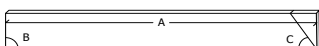

FSL/1500	1443	90	70	<b>4</b>	frontale sierlat / latte de finition frontale <b>Afzagen op lengte van 1443mm (A) en 1 hoek in verstek op 70° (C)</b> <b>Scier à la longueur de 1443 mm(A) et 1 coin à un angle de 70° (C)</b> <b>Zie montage instructie - Voir instructions de montage (stap 47 - point 47)</b>
----------	------	----	----	----------	---



ZSL/3550	3550	(-)	(-)	<b>2</b>	zij sierlat tegen dakplanchet / finition latérale contre planchette du toit
----------	------	-----	-----	----------	--

DDC03-S				<b>1</b>	deur cottage voor slot / porte double cottage pour serrure
DDC03-V				<b>1</b>	deur cottage vast / porte cottage fixe
A/DDO	(3 delen / 3 pièces)			<b>1</b>	kader 28mm voor dubbele deur cottage / cadre 28mm pour porte double cottage

A/EVR03/PLXH				<b>1</b>	vast raam / fenêtre fixe
--------------	--	--	--	----------	--------------------------

B/3504				<b>1</b>	zak beslag / sachet quincaillerie
--------	--	--	--	----------	-----------------------------------

3184P/1-8				<b>8</b>	pakken shingles / paquets de bardeaux
-----------	--	--	--	----------	---------------------------------------

Onderdelenlijst  
Liste d'inventaire

Typ  
diamond

**28mm 355x295 cm WDDDC03**

**3504AB295**

Artikel nr / Dimension # Functie / Fonction  
Nr Article A B C

Wandelementen / Eléments des parois

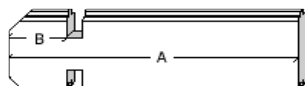

C1/1039/0100 1039 100 (-) **4** naast deur voorgevel / côté porte façade

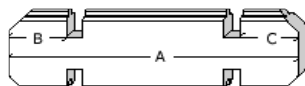

C3/3550/0100/0100 3550 100 100 **2** voor- en achtergevel / façade et paroi arrière  
C3/3550/0100/0100 3550 100 100 **4** zijgevel / paroi latérale

Dakelementen / Eléments du toit



CK/CM4/3550/QQ001 3550 (-) (-) **1** puntgevel te assembleren midden /  
pignon à assembler parois centrale

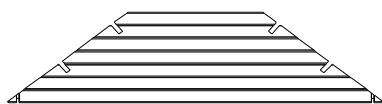

CK/CM7/3550/QQ001 3550 (-) (-) **1** puntgevel te assembleren midden /  
pignon à assembler parois centrale

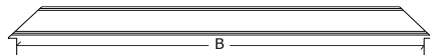

CK/C2/3550/5/4-B 3550 3204 (-) **1** onderste element voor CK/C7/3550/QQ001 /  
élément inférieur pour CK/C7/3550/QQ001

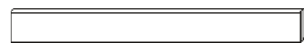

S/028/045/1000 1000 28 45 **1** versteviging puntgevel / renfort pignon

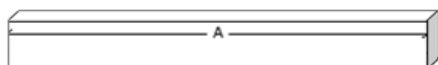

P4/2950 2950 120 44 **4** dakbalk / panne de toit  
P4/3050 3050 120 44 **2** ligger / traverse

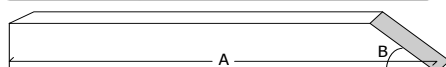

599907 2459 45 90 **1** voorste nokbalk / panne faîtière frontale  
599909 3060 45 90 **1** achterste nokbalk / panne faîtière arrière

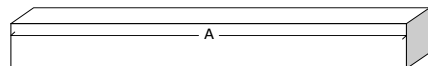

S/120/120/1876 1876 120 120 **2** paal / poteau

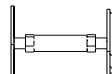

300035 290 120 120 **2** U-anker / U-socle



DP/2380 2380 (-) (-) **52** dakplanchet / planchette du toit

Afwerkingselementen / Eléments de finition



ZSL/2950 2950 (-) (-) **2** zijsierlat tegen dakplanchet /  
finition latérale contre planchette du toit

B/3504AB **1** zak beslag / sachet quincaillerie

3184P/1-8 **5** pakken shingles / paquets de bardeaux

Onderdelenlijst  
Liste d'inventaire

Typ  
diamond

**28mm 355x290 cm WDDDC03**





**3504ABXXL290**

Artikel nr  
Nr Article

Afmeting / Dimension  
A B C

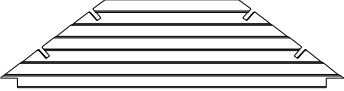
# Functie / Fonction

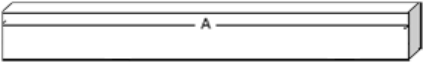
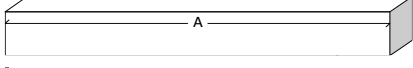
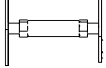
Dakelementen / Éléments du toit

	CK/CM4/3550/QQ001	3550	(-)	(-)	<u>1</u>	puntgevel te assembleren / pignon à assembler
	CK/CM7/3550/QQ002	3550	(-)	(-)	<u>1</u>	puntgevel te assembleren / pignon à assembler
	S/028/045/1000	1000	28	45	<u>1</u>	verstevinging puntgevel / renfort pignon
	P4/2900	2900	120	44	<u>7</u>	ligger, dakbalk, nokbalk / traverse, panne (faîtière)
	S/120/120/1876	1876	120	120	<u>2</u>	paal / poteau
	300035	290	120	120	<u>2</u>	U-anker / U-socle
	DP/2380	2380	(-)	(-)	<u>52</u>	dakplanchet / planchette du toit

Afwerkingselementen / Éléments de finition

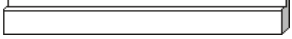
	ZSL/2900	2900	(-)	(-)	<u>2</u>	zijserlat tegen dakplanchet / finition latérale contre planchette du toit
	B/3504AB				<u>1</u>	zak beslag / sachet quincaillerie
	3184P/1-8				<u>5</u>	pakken shingles / paquets de bardeaux

# 28MM 355X290 CM WDDDC03 (ART3504ABXXL290)

## VOORZIJDE - FACADE

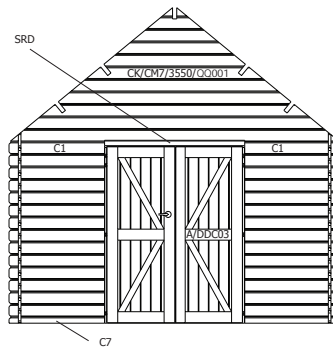
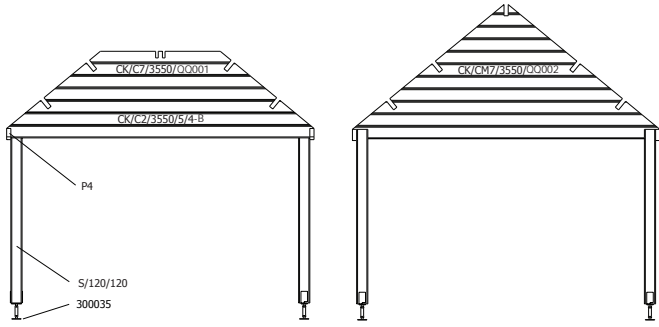

## RUGZIJDE PAROI ARRIERE

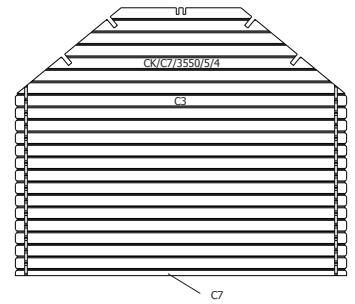

## ZIJWAND - PAROI LATERALE

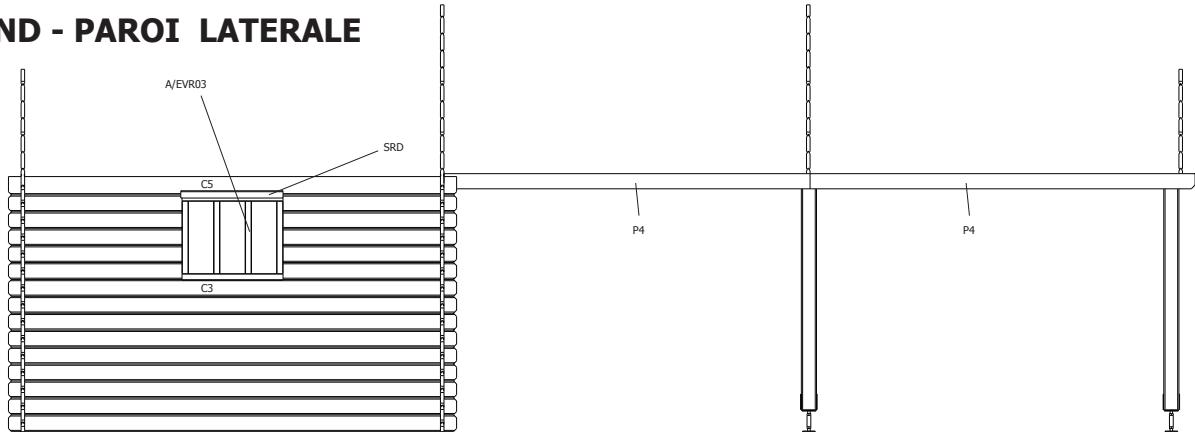

## ZIJWAND - PAROI LATERALE

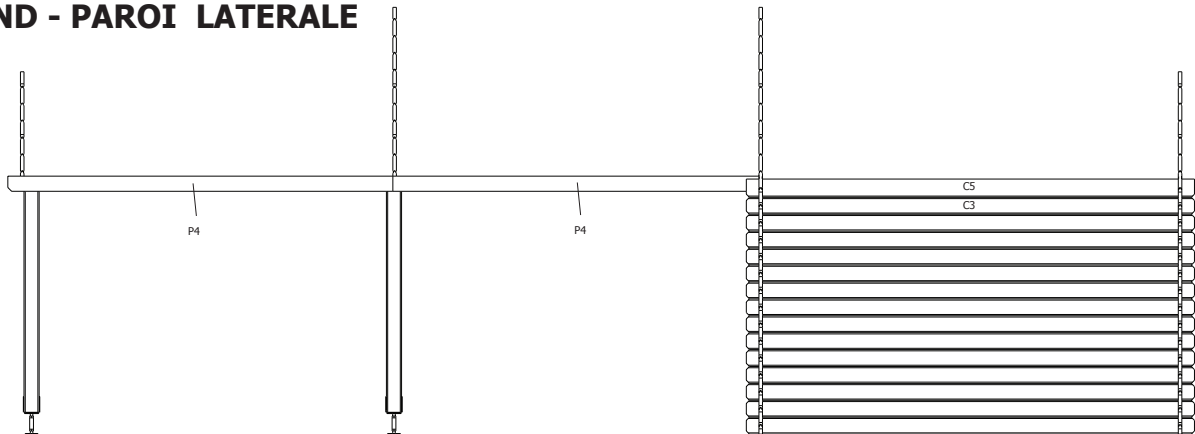

## DAK - TOITURE

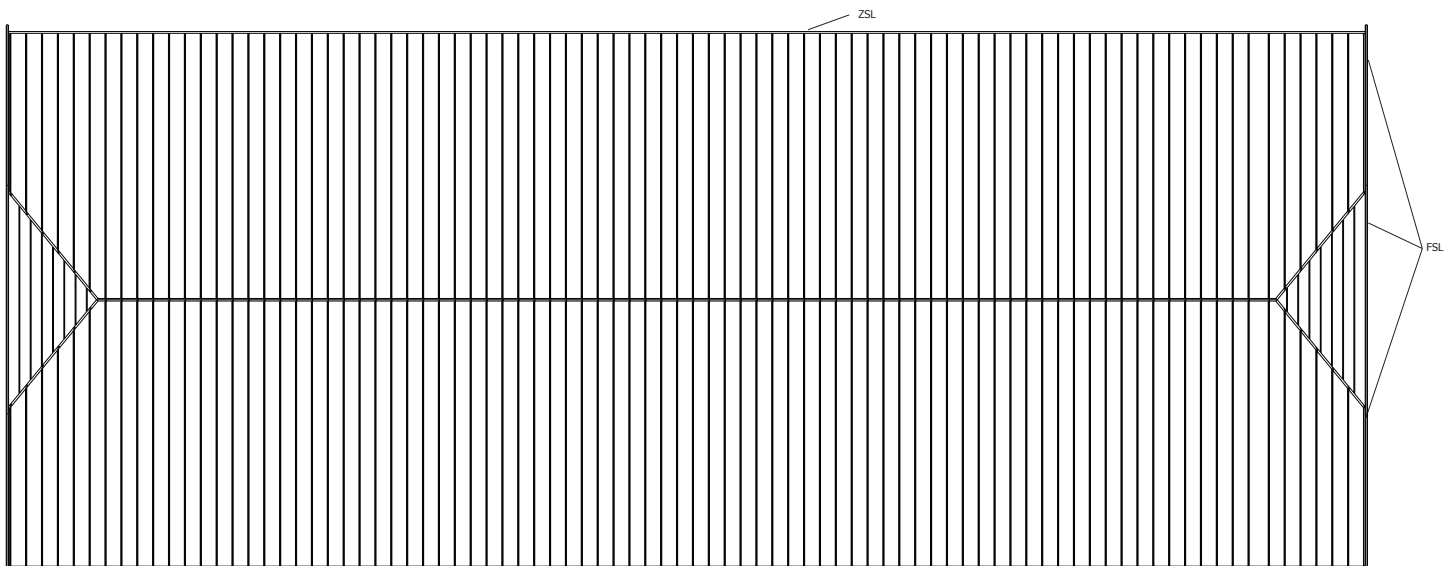

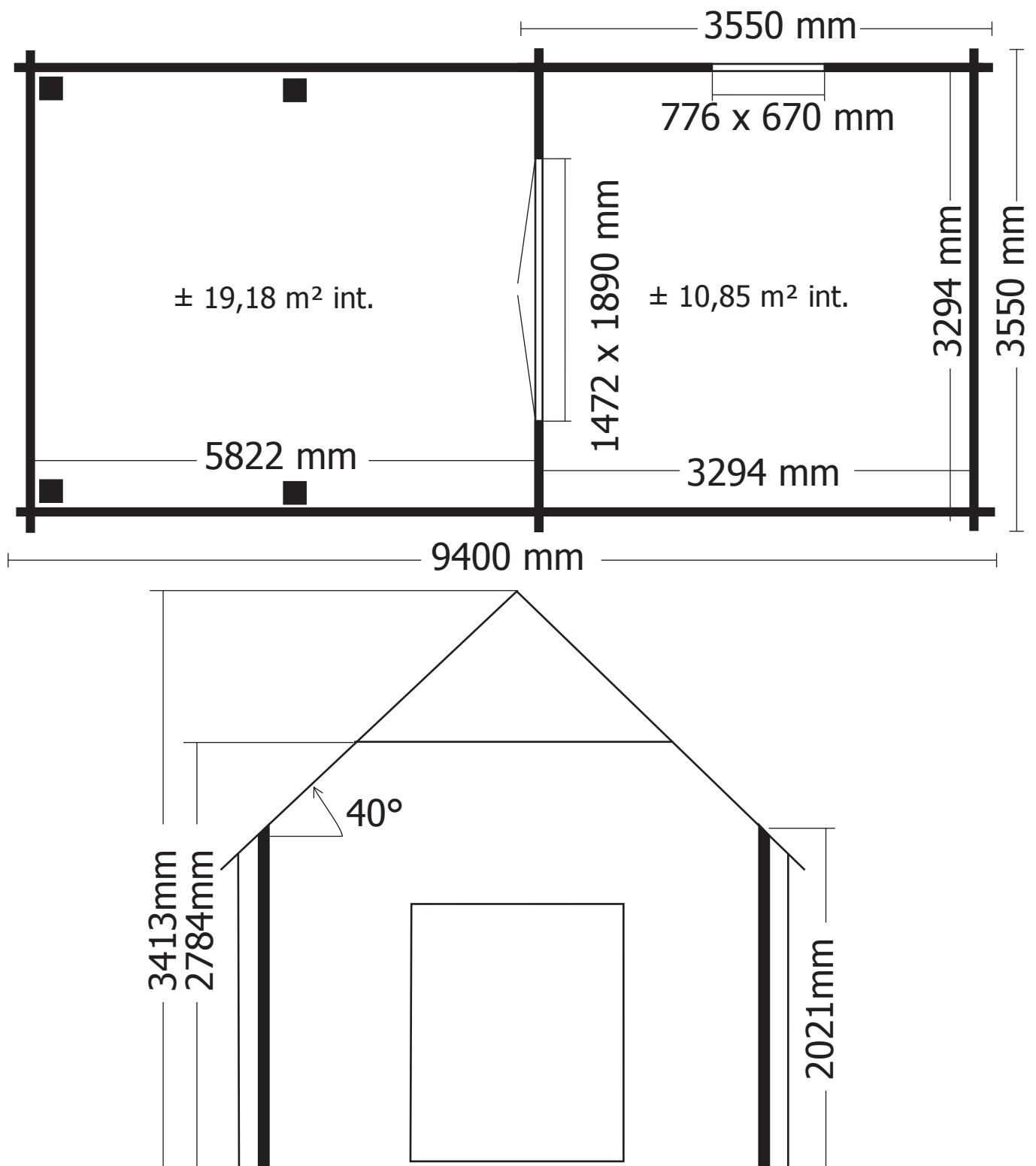

**OPGELET** : Behandel **ELK** onderdeel grondig aan alle zijden met een degelijk product dat beschermt tegen zon, weer en wind en tegen insecten en schimmels, **VOOR** de montage.

**ATTENTION** : Traitez à fond **CHAQUE** élément avec un produit protégeant contre les intempéries, les insectes et les moisissures intérieur et extérieur, **AVANT** le montage .

## B/3504

aantal / nombre

Slot - Serrure (leverlock)  
(Ref = 330003)



1

Kantschuif - Pêne (120mm)  
(Ref = 300019)



2

Scharnier paumelle groot - Charnière paumelle grand  
(Ref = 300014)

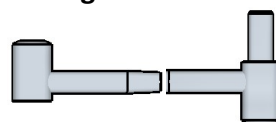

8 set

Hoekijzer groot - Equerre grand (60x60x40)  
(Ref = 300024)

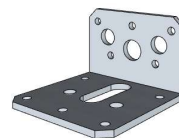

2

Hoekijzer klein - Equerre petit (30x30x30)  
(Ref = 300026)

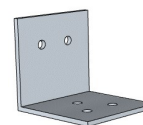

4

### Nagels - Clous

2,5x50mm  
(Ref = 361001)



1 x 750

3x14mm  
(Ref = 362001)



2 x 300 g

### Schroeven - Vis

25mm  
(Ref = 310018)



30

35mm  
(Ref = 310007)



28

50mm  
(Ref = 310013)



28

70mm  
(Ref = 310009)



48

## B/3504AB

aantal / nombre

Rondel - Rondelle (M8)  
(Ref = 330001)

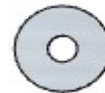

16

Houtdraadbout - Boulon (8x70)  
(Ref = 340001)



8

Houtdraadbout - Boulon (7x90)  
(Ref = 340003)



8

Balkverbinder groot - Connecteur de poutre grand (105mm)  
(Ref = 300032)

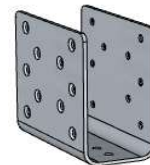

5

### Nagels - Clous

2,5x50mm  
(Ref = 361001)



1 x 750

3x14mm  
(Ref = 362001)



2 x 300 g

### Schroeven - Vis

25mm  
(Ref = 310018)



50

35mm  
(Ref = 310007)



28

50mm  
(Ref = 310013)

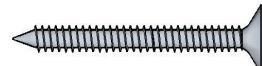

28

70mm  
(Ref = 310009)



48